



# DURABLE SUPERIOR CASTERS®

MANUFACTURER OF CASTERS AND WHEELS 60LB-40,000LB CAPACITY

2017-2018 CATALOG

CASTERS



1-800-848-4517

WWW.DURABLECASTERS.COM





# INNOVATION

FOR BETTER QUALITY AND PRODUCTS



TACOMA, WA

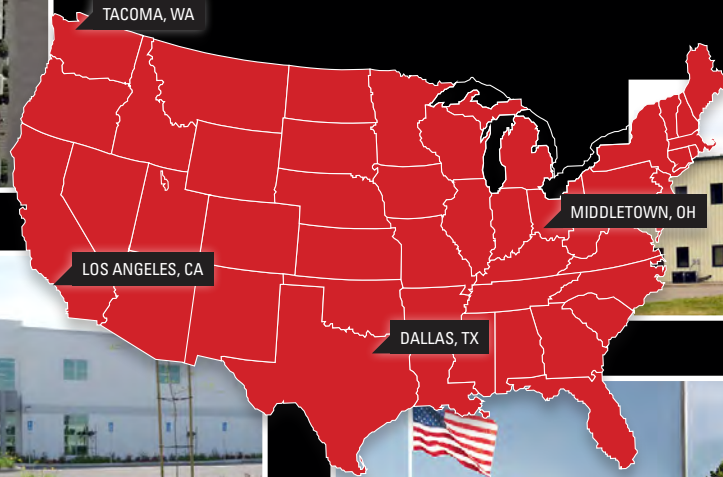

MIDDLETOWN, OH

LOS ANGELES, CA



DALLAS, TX



# COMMITMENT

TO INVENTORY AVAILABILITY

# SUPPORT

FROM MOST EXPERIENCED AND KNOWLEDGEABLE SALES AND SERVICE STAFF



## Table of Contents

Product Index	3	 <b>57/58</b> – Heavy Duty Forged Series – 6,000 lb	77
Specialty Casters	6	 <b>55/56</b> – Heavy Duty Forged Series – 3,500 lb	80
 <b>01, 03/04, 05/06, A5, A9</b> – Low Profile Machinery Series – 1200 lb 	7	 <b>61/62</b> – Heavy Duty Kingpinless Series – 7,000 lb	83
 <b>A9</b> – Low Profile Swivel and Total Lock Caster – 180 lb 	8	 <b>63/64</b> – Extreme Duty Kingpinless Series – 20,000 lb	86
 <b>MS</b> – Light Duty Swivel Series – 150LB	9	 <b>65/66</b> – Extreme Duty Kingpinless Series – 20,000 lb	88
 <b>8A/8R</b> – Light Duty Swivel Series – 150LB 	9	 <b>D1/R1</b> – Dual Wheel Kingpinless Series – 6,000 lb	89
 <b>08</b> – Light Duty Series – 110 lb 	10	 <b>D2/R2</b> – Dual Wheel Kingpinless Series – 7,000 lb	93
 <b>11/12</b> – General Duty Series – 500 lb 	11	 <b>D3/R3</b> – Dual Wheel Kingpinless Series – 20,000 lb	95
 <b>09/10/T2</b> – Light Duty Institutional Series – 175 lb 	12	 <b>D4/R4</b> – Dual Wheel Kingpinless Series – 40,000 lb	97
 <b>23/24</b> – Light Medium Duty, Economy Series – 200 lb 	13	 <b>15/16, 7H/73/74, S7/S8/S9</b> – Stainless Series – 350 lb  	98
 <b>13/14</b> – Light Medium Duty, Plate Mount Series – 350 lb 	15	 <b>25</b> – Stainless Bakery Series – 700lb	102
 <b>21, 75/76/78</b> – Light Medium Duty with Dust Cover Series – 350 lb 	18	 <b>B1/B2, 31/32/TS, S5/S6</b> – Stainless Steel Series – 1250LB 	102
 <b>T1, T3, 17, FS, TH, F7</b> – Total Lock and Directional Lock – 350 lb 	22	 <b>4S</b> – Stainless Modular Series – 1500LB 	105
 <b>07/17/75/T3/FS/76</b> – Modular Stem, Hollow Kingpin, Swivel/Total Lock – 350LB  	26	<b>67/68</b> – Pneumatic, Ever-Roll™ and Eco-Rubber™ Series	107
 <b>79/80/T9</b> – Stamp-Formed Series – 450 lb 	30	<b>59, TS</b> – Roadie® – The Ultimate Case Series	108
 <b>H9/H0</b> – Stamp-Formed Series – 660 lb 	33	<b>69/70</b> – Brass-Plated Series	108
 <b>27/28/39/DT/FT</b> – Medium Duty Series (OEM Preferred Series) – 1,250 lb 	36	<b>FH</b> – Chariot™ – Premium Chair and Equipment Series	109
 <b>49/50</b> – Momentum™ – Precision Tapered Raceway Series – 2,000 lb	44	<b>P5/PT</b> – Polimed™ Composite Polymer Series 	109
 <b>41, 45, 4A, 46</b> – Medium Heavy Duty Kingpinless Series – 2,500 lb 	48	<b>PL</b> – Polima – Swivel and Directional Lock Series 	110
 <b>4K/4R</b> – High Performance Maintenance Free Extended Swivel Lead Series – 2,500LB 	53	<b>37/38</b> – Spring Loaded Medium-Heavy Duty Series	110
 <b>4L</b> – Modular Stem Series – 1500LB 	57	<b>G1, G2, G3</b> – Spring Loaded Gate Series	112
 <b>43/44</b> – Medium Heavy Duty Series – 1,500LB	60	<b>3S, 3R</b> – Spring Loaded Medium Heavy Duty Series 	113
 <b>81/82</b> – Heavy Duty, Economy Industrial Series – 1,800lb	64	<b>SA/SB</b> – Light Duty Spring-Loaded Institutional Series 	115
 <b>47/48</b> – Medium Heavy Duty Kingpinless Series – 2,000lb	65	<b>H5, 17, T3, 19, 75</b> – Adjustable Height Series	115
 <b>51/52</b> – Medium Heavy Duty Forged Series – 2,000 lb	69	<b>A3, H3, 03</b> – Inverted Aircraft Loading Series	117
 <b>53/54</b> – Heavy Duty Forged Series – 2,400 lb	74	<b>20</b> – Shopping Cart/Laundry Cart Series 	118
		<b>Low Rider</b> – Appliance Series	118
		<b>LV</b> – Leveling Series	118



**PRODUCT INDEX**

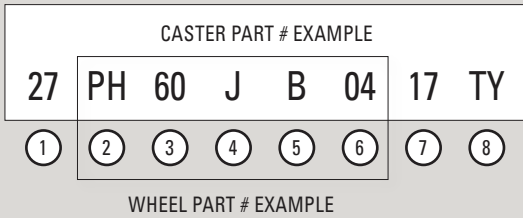

① CASTER SERIES		
Code	DESCRIPTION	Page
01, 03/04, 05/06, A5, A9	LOW PROFILE MACHINERY SERIES – 1200LB	7
A9	LOW PROFILE SWIVEL AND TOTAL LOCK CASTER – 180LB	8
MS	LIGHT DUTY SWIVEL SERIES – 150LB	9
8A/8R	LIGHT DUTY SERIES – 150LB	9
08	LIGHT DUTY SERIES – 150LB	10
11/12	GENERAL DUTY SERIES – 500LB	11
09/10/T2	LIGHT DUTY INSTITUTIONAL SERIES – 175LB	12
23/24	LIGHT MEDIUM DUTY, ECONOMY SERIES – 200LB	13
13/14	LIGHT MEDIUM DUTY, PLATE MOUNT SERIES – 350LB	15
21, 75/76/78	LIGHT MEDIUM DUTY WITH DUST COVER SERIES – 350LB	18
T1, T3, 17, FS, TH, F7	TOTAL LOCK AND DIRECTIONAL LOCK – 350LB	22
07/17/75/T3/FS/76	MODULAR STEM, HOLLOW KINGPIN, SWIVEL TOTAL LOCK – 350LB	26
79/80/T9	STAMP-FORMED SERIES – 450LB	30
H9/H0	STAMP-FORMED SERIES – 660LB	33
27/28/39/DT/FT	MEDIUM DUTY SERIES (OEM PREFERRED SERIES) – 1,250LB	36
49/50	MOMENTUM™ – PRECISION TAPERED RACEWAY SERIES – 2,000LB	44
41, 45, 4A, 46	MEDIUM HEAVY DUTY KINGPINLESS SERIES – 2,500LB	48
4K/4R	HIGH PERFORMANCE EXTENDED SWIVEL LEAD SERIES – 2,500LB	53
4L	MODULAR STEM SERIES – 1500LB	57
43/44	MEDIUM HEAVY DUTY SERIES – 1,500LB	60
81/82	HEAVY DUTY, ECONOMY INDUSTRIAL SERIES	64
47/48	MEDIUM HEAVY DUTY KINGPINLESS SERIES – 2,000LB	65
51/52	MEDIUM HEAVY DUTY FORGED SERIES – 2,000LB	69
53/54	HEAVY DUTY FORGED SERIES – 2,400LB	74
57/58	HEAVY DUTY FORGED SERIES – 6,000LB	77
55/56	HEAVY DUTY FORGED SERIES – 3,500LB	80
61/62	HEAVY DUTY KINGPINLESS SERIES – 7,000LB	83
63/64	EXTREME DUTY KINGPINLESS SERIES – 20,000LB	86
65/66	EXTREME DUTY KINGPINLESS SERIES – 20,000LB	88
D1/R2	DUAL WHEEL KINGPINLESS SERIES – 6,000LB	89
D2/R2	DUAL WHEEL A90 KINGPINLESS SERIES – 7,000LB	93
D3/R3	DUAL WHEEL KINGPINLESS SERIES – 20,000LB	95
D4/R4	DUAL WHEEL KINGPINLESS SERIES – 40,000LB	97
15/16, 7H/73/74, S7/S8/S9	STAINLESS SERIES – 350LB	98
25	STAINLESS BAKERY SERIES – 700LB	102
B1/B2, 31/32/TS, S5/S6	STAINLESS STEEL SERIES – 1250LB	102
4S	STAINLESS MODULAR SERIES – 1500LB	105
67/68	PNEUMATIC, EVER-ROLL™ AND ECO-RUBBER™ SERIES	107
59, TS	ROADIE® – THE ULTIMATE CASE SERIES	108
69/70	BRASS-PLATED SERIES	108
FH	CHARIOT™ – PREMIUM CHAIR AND EQUIPMENT SERIES	109
P5/PT	POLIMED™ COMPOSITE POLYMER SERIES	109
PL	POLIMA – SWIVEL AND DIRECTIONAL LOCK SERIES	110
37/38	SPRING LOADED MEDIUM-HEAVY DUTY SERIES	110
G1, G2, G3	SPRING LOADED GATE SERIES	112
3S, 3R	SPRING LOADED GATE SERIES	113
SA/SB	LIGHT DUTY SPRING-LOADED INSTITUTIONAL SERIES	115
H5, 17, T3, 19, 75	ADJUSTABLE HEIGHT SERIES	115
A3, H3, 03	INVERTED AIRCRAFT LOADING SERIES	117
20	SHOPPING CART/LAUNDRY CART SERIES	118
LOW RIDER	APPLIANCE SERIES	118
LV	LEVELING SERIES	118

② WHEEL TYPE			
Code	Name or Wheel Type	Code	Name or Wheel Type
SR	SOLID RUBBER SOFT TREAD	HU	ERGOLASTOMER™
HR	SOLID HARD RUBBER	UN/US	WELDED DISC™ POLYURETHANE
		DW	DUAL-WHEEL
RK	GRAYROK™	PO/HP	POLYOLEFIN
NR	RUBBER ON NYLON	MA	MAXROK™
RD	RODIE®	NY	NYLON
SF	SUPER-SOFT™	NX	IRONMAN™
CR	CUSHION RIDE™	ET	ELITE
BC	DURA-CUSHION™	PH	PHENOLIC
RA	RUBBER ON ALUMINUM	HI	ROKHARD™
		GN	BRIMSTONE®
RS	CAST IRON MOLD-ON RUBBER	OV	EPOXY WHEELS
		HT	HIGH-TEMP PHENOLIC
RH	SUPREME RUBBER	BF/SL	STEROLLIZER®
LP	LOW PROFILE MOLD-ON RUBBER	FP	FULL PNEUMATIC TIRES
EN	NEO-ENERGIZER™	SN	SEMI-PNEUMATIC TIRES WITH METAL HUB
CN	CONDUCTIVE THERMO RUBBER		FF
CT	CONDUCTIVE SOLID RUBBER WHEELS	ER	EVER-ROLL™ TIRES
EL	ELEMENT™	LS	XTREME WHEEL
NM	NOMADIC™	RT	ELASTORIDE™
TP	THERMO-PRO™	SN	ECO-RUBBER™ TIRES
PP	POLY-PRO™	PC/PS	PALLET JACK
PM	POLYMAC™	BR	BOGEY AND NOSE ROLLERS
MU	POLYON MAXROK™		SS
PR	POLYON-C	HS	HEAVY-DUTY SEMI-STEEL
CP	CHAMPION™		SI
PA	POLYON-AL™	DS	DUCTILE STEEL WHEELS
PU	POLYON™	CD	ENERGY SAVER DUCTILE™
RP	POLYFLEXON®	FS	DROP-FORGED STEEL
UA	POLYFLEXON™	MV	MAXROK™ V-GROOVE
UD	D-POLYON™	VG	CAST IRON V-GROOVE
UX	SUPER ELASTOMER	DV	DUCTILE V-GROOVE
EX	ULTRA-POLY™	FV/SV	FORGED AND SOLID STEEL V-GROOVE
PX	TITAN™ POLYMER		
SW	ENERGY SAVER POLYON		
SU	DURALASTOMER™		
SX	ELASTOMER		

③ WHEEL DIAMETER	
Code	Diameter
16	1-5/8" OR 16"
20	2"
25	2-1/2"
30	3"
31	3"
34	3-1/4"
35	3-1/2"
40	4"
4H	4"
4Z	4"
50	5"
54	5"
5H	5"
60	6"
61	6"
65	6"
66	6"
80	8"
81	8"
85	8"
89	8"
10	10"
1A	10"
12	12"
14	14"
16	1-5/8" OR 16"
18	18"
20	20"

④ WHEEL WIDTH	
Code	Measurement
0	3/4"
A	13/16"
B	7/8"
C	15/16"
D	1"
E	1-3/4"
F	1-1/4" W/1-15/16" HL
G	1-1/4"
H	1-1/2"
I	1-13/16"
J	2"
K	2-1/2"
L	3"
M	3-1/2"
N	4"
O	5"
P	1-5/8"
Q	2-1/2" W/ 3-1/4" HL
R	1-1/4" W
	1-13/16" HL
S	PHENOLIC STRAIGHT SIDED
T	2" STRAIGHT SIDE
V	1-3/8"
U	2-3/4"
W	11/16"
V	1-3/8"
S	1-1/2" TREAD WIDTH, 1-1/2" HL

5 WHEEL COLOR	
Code	Color
A	BLACK/GRAY
B	BLACK
C	BLACK/BLACK
C	PNEUMATIC CENTERED HUB
D	RED/GRAY
E	WHITE
F	BLACK/BRASS
F	DARK BLUE/GRAY
G	DARK GRAY/WHITE
H	GRAY/BLACK
I	GRAY/GRAY
J	WHITE/DONUT
K	RED/BLACK
L	BLUE
M	MAROON
N	GREEN
O	ORANGE
O	ORANGE PNEU. OFFSET HUB
O	ORANGE HIGH TEMPERATURE
P	PURPLE/GRAY
P	GRAY PU/BLACK/CROWN
Q	BROWN
R	RED
S	SILVER-STEEL
S	ROYAL BLUE/GRAY
T	GRAY/BEIGE/FLAT
T	7/8 GROOVE
U	BLUE/BLACK
V	RED/SILVER
V	1-3/4 V GROOVE
W	GRAY/GRAY OFFSET
W	RED/WHITE
W	1-3/8 GROOVE
X	GRAY/DONUT
Y	GRAY/BEIGE/DONUT
Z	BLACK/CROWN

6 BEARING OPTIONS							
Code	Type	Spec	Code	Type	Spec		
80	PLAIN BORE	1/4	A3	ROLLER BEARINGS	1/2 X 1-3/16 X 1.375		
81		5/16	01		5/8 X 1-3/16 X 1-3/8		
82		3/8	02		5/8 X 1-3/16 X 1-7/8		
83		1/2	03		3/4 X 1-3/16 X 1-3/8		
84		1-3/16	04		3/4 X 1-3/16 X 1-7/8		
85		1-15/16	05		S. S. 04		
86		2-7/16	06		3/4 X 1-3/16 X 2-1/2		
87		1-7/16	07		3/4 X 1-7/16 X 2		
88		3/4	08		3/4 X 1-3/16 X 1-3/4		
89		7/8	09		CAGED 04		
90		1/2 BUSHED TO 3/8	10		CAGED 03		
91		3/8 BUSHED TO 5/16	21		7/8 X 1-7/16 X 2		
95		1-3/8	22		1 X 1-7/16 X 2		
97		S. S. 1/2 TO 3/8 TOP HATS	23		1 X 1-15/16 X 2-1/2		
98		1-1/8	24		1 X 1-15/16 X 3		
99		1/2 TO 3/8 TOP HATS	25		1-1/4 X 1-15/16 X 2-1/2		
41		BALL BEARINGS	5/16 X 1-1/16		26	ROLLER BEARINGS	1-1/4 X 1-15/16 X 3
42			3/8 X 1-1/16		27		1-1/4 X 2-7/16 X 3
43			3/8 ANNULAR		28		1-1/2 X 2-7/16 X 3
51			1/2 X 1-3/8		29		1/2 X 15/16 X 1-3/4
48	1/2" I. D. DUAL ROW ANNULAR		31	1-1/4 X 1-7/16 X 4			
52	5/8 X 1-3/8		32	1-1/4 X 2-7/16 X 5			
53	3/4 X 1-3/8		33	1-1/2 X 2-7/16 X 4			
76	S. S. 3/8 X 1-1/16		34	1-1/2 X 2-7/16 X 5			
8A	1/2" I. D. DUAL ROW ANNUAL BEARING		35	1 X 1-15/16 X 4			
60	1/2 X 1-3/16		36	3/4 X 1-3/16 X 1-5/8			
69	3/4 X 1-15/16	37	1-1/4 X 1-15/16 X 4				
6S	PRECISION BALL BEARINGS	1/2 FLANGED S. S. 1/2 X 1-3/16	38	DELTRIN BEARINGS	3/4 X 1-3/8 X 3		
6M		FOR 1-5/8 HUB LENGTH	39		1-1/2 X 2-7/16 X 3-1/2		
P1		1/2 X 1-3/8	40		3/4 X 1-3/8 X 3-7/8		
P2		5/8 X 1-3/8	92		04 W. SPANNER TO 1/2"		
P3		3/4 X 1-3/8	11		1 PC - 3/4 I. D.		
P4		3/8 X 1-1/8	12		1 PC - 1/2 I. D.		
44		3/8 W/FULL T. G.	55		2 PC - 3/8 X 1-1/16		
46		1/2	56		2 PC - 1/2 X 1-3/16		
45		3/8 W/SMALL T. G.	57		2 PC - 3/4 X 1-3/16		
47		3/8 W/BEARING CAP	58		2 PC - 1 X 1-15/16		
4S	S. S. 3/8 W/FULL T. G.	59	2-PC - 1/2" X 1-1/8"				
T3	SINGLE PRECISION BEARINGS	W/1/2" I. D. TOP HATS	5A	BRONZE BEARINGS	1/2" FLANGED WHITE		
T4		W/3/4" I. D. TOP HATS	96		3/4 X 1-3/16 X 2-3/4		
T5		W/1" I. D. TOP HATS	77		1 X 1-15/16 X 2-3/4		
T6		W/1-1/4" I. D. TOP HATS	78		1 X 1-15/16 X 3-1/4		
T7		W/1/2" I. D. TOP HATS	70		1/2		
14		6205 - 1/2 FOR 2" WIDE	71		1		
15		6205 W/T. P. 3/4	73		70 BEARING W/ THS702712 - 1/2 I. D.		
16		6205 W/T. P. 5/8			1-1/4		
49		6203 W/1/2" I. D. BUSHING					
61		6201 W/1/2" I. D. BUSHING					
62	SEALED PRECISION BALL BEARINGS WITH TOP HAT BUSHINGS	6202 W/1/2" I. D. BUSHING					
63		6203 - 1/2" FOR 2" WIDE					
64		6204 - 1/2" FOR 2" WIDE					
65		6205					
67		6205-1					
68		6207					
65I		6205-16 - 1" I. D.					
72		S. S. 6203 T. H. 1/2					
5P		W/ 3/4" I. D. TOP HATS					
7P		W/ 1" I. D. TOP HATS					
8P	W/ 1-1/4" I. D. TOP HATS						
S3	S. S. 6203 - 1/2 FOR 2" WIDE						

7 CASTER FASTENING PATTERN - PLATE			
Code	Plate Dimension	Bolt Hole Patter	Mount. Bolt
01	1-1/4 X 2-1/16	13/16 X 1-9/16	3/16"
P4	1-1/2 X 1-1/2	1 X 1	7/32"
09	1-1/2 X 2-1/8	15/16 X 1-5/8	3/16"
8S	1-1/2 X 2-1/2	1 X 2	1/4"
00	1-1/2 X 2-21/32	15/16 X 2-1/8	1/4"
05	1-3/4 X 3	1 X 2-1/4	1/4"
08	1-3/4 X 3	1 X 2-3/16 TO 2-5/16	5/16"
02	1-7/8 X 2-9/16	15/16 X 2-1/8	1/4"
P5	2-1/16 X 2-9/16	1-5/8 X 2	1/4"
03	2-1/4 X 4-7/16	1-1/16 X 3-1/2	1/4"
04	2-1/4 X 5-1/8	1-3/16 X 4	1/4"
P2	2-3/8 X 2-3/8	1-1/2 X 1-1/2 TO 1-7/8 X 1-7/8	5/16"
06	2-3/8 X 3-5/8	1-3/4 X 2-7/8 TO 3	5/16"
07	2-5/8 X 3-11/16	1-3/4 X 3	1/4"
14	3-1/4 X 4-5/8	2-3/8 X 3-3/8	5/16"
16	3-1/2 X 3-1/2	2-5/8 X 2-5/8 TO 2-3/4 X 2-3/4	5/16"
U1	3-1/2 X 3-1/2	1-3/4 X 2-7/8 AND 2-7/8 X 2-7/8	5/16"
15	3-1/4 X 6-1/4	1-3/4 X 5	3/8"
MS	3-1/8 X 3-3/4	1-5/8 X 3 TO 2-5/16 X 3-1/8	5/16"
12	3-1/8 X 4-1/8	2-3/8 X 3-3/8	1/4"
11	3-1/8 X 4-1/8	1-3/4 X 2-15/16 TO 2-3/8 X 3-3/8	3/8"
13	3-3/4 X 4-1/2	2-5/8 X 3-5/8 TO 3 X 3	3/8"
P3	3-3/8 X 4-1/8	2-1/8 X 2-7/8 TO 2-5/8 X 3-3/8	5/16"
17	4 X 4-1/2	2-5/8 X 3-5/8 TO 3 X 3	3/8"
18	4 X 5	3 X 4	1/4"
19	4-1/2 X 6-1/4	2-7/16 X 4-15/16 TO 3-3/8 X 5-1/4	1/2"
A7	4-3/8 X 3-13/16	2-5/8 X 3-5/8 TO 3 X 3	3/8"
20	5 X 5-1/2	4-1/8 X 4-1/2	3/8"
25	5-1/4 X 7-1/4	3-3/8 X 5-1/4 TO 4-1/8 X 6-1/8	1/2"
P1	5-15/16 X 6-11/16	4-1/8 X 5-1/2	1/2"
29	6 X 7-1/2	4-1/2 X 6 TO 4-1/8 X 6-1/8	1/2" OR 9/16"
30	6-1/4 X 7-1/2	4-1/2 X 6 TO 4-1/8 X 6-1/8	1/2" OR 9/16"
10	78MM X 99MM	60MM X 80MM	5/16"
21	79MM X 104MM	60MM X 86MM TO 88MM	5/16"
45	8-1/2 X 8-1/2	7 X 7	5/8"
DP	DIAMOND 3-1/32 X 4-3/8	3-1/2	7/16"
99	PENTAGON PLATE 2 X 5-1/2 X 5-1/2 X 2	SEE PICTURE	5/16"
A2	3-1/8 X 4-1/8		
ZZ	HOLLOW KINGPIN	1/2" DIAMETER	



# DURABLE SUPERIOR CASTERS®

## 7 CASTER FASTENING PATTERN

THREADED STEMS (UNC)		GRIP RING STEMS		ADAPTER STEMS	
Code	Stem	Code	Stem	Code	Stem
83	1/4 - 20 X 1/2	54	ROUND 3/8 X 1 - 1 RING	71	WITH ADAPTER ADP7134
32	5/16 - 18 X 3/4	F9	ROUND 7/16 X 3/4 - 1 RING	72	WITH ADP7278
31	5/16 - 18 X 1	53	ROUND 7/16 X 7/8 - 1 RING	7B	WITH ADP7992
34	5/16 - 18 X 1-1/2	9A	ROUND 7/16 X 7/8 - 1 RING	73	WITH ADP7310
63	3/8 - 16 X 1/2	90	ROUND 7/16 X 1-3/16 - 1 RING	7A	WITH ADP7A16
60	3/8 - 16 X 3/4	91	ROUND 7/16 X 1-3/8 - 1 RING	74	WITH ADP7418
61	3/8 - 16 X 1	49	ROUND 7/16 X 2 - RING	78	WITH ADP7814
58	3/8 - 16 X 1-1/4	96	ROUND 13/16 X 1-3/4 - 1 RING	75	WITH ADP7538
64	3/8 - 16 X 1-3/8	93	ROUND 13/16 X 2-3/16 - 2 RING	76	WITH ADP7615
62	3/8 - 16 X 1-1/2	94	ROUND 27/32 X 2-1/2 - 1 RING	77	WITH ADP7717
6A	3/8 - 16 X 2	95	ROUND 0.846 X 2-3/16 - 1 RING	R1	WITH ADS7134
3A	7/16 - 14 X 3/4	92	ROUND 5/8 X 2-3/16 2 RING	R2	WITH ADS7278
33	7/16 - 14 X 1-1/2	48	ROUND 0.865 X 2-1/4 - 2 RINGS	R3	WITH ADS7310
7A	7/16 - 14 X 1-3/4	G4	ROUND 7/8 X 1.875 - 1 RING	R4	WITH ADS7418
79	7/16 - 14 X 2-1/4	85	ROUND 1 X 2-3/16 - 2 RINGS	R5	WITH ADS7538
C6	7/16 - 14 X 5	A6	ROUND 1-1/8 X 2-3/16 - 2 RINGS	R6	WITH ADS7615
6S	1/2 - 13 X 3/8	22	ROUND 1.25 X 2-3/16 - 2 RINGS	R7	WITH ADS7717
35	1/2 - 13 X 1/2	23	ROUND 1-3/8 X 2-3/16 - 2 RINGS	U2	WITH ADR7278
66	1/2 - 13 X 3/4	43	SQUARE 9/16 X 2-15/16, 2 X 5/16" CRX DRL	U5	WITH ADR7538
67	1/2 - 13 X 1	51	OCTAGON 3/4 X 2 W/3 X 1/4" CRX DRL	D2	WITH ADT7278
68	1/2 - 13 X 1-1/2	52	OCTAGON 3/4 X 2-3/16 W/3 X 1/4" CRX DRL	T2	WITH ATR7278
6M	1/2-13 X 1-9/16	55	SQUARE 7/8 X 2 CRX SEC. 1.087" 3 CRX DRILL	S2	WITH ASP7278
59	1/2 - 13 X 1-3/4	56	OCTAGON 7/8 X 2 CRX SEC. 0.983, 3 CRX DRILL	S3	WITH ASP7310
69	1/2 - 13 X 2	42	OCTAGON 7/8 X 2 W/ 5/16 CRX DRL	S6	WITH ASP7615
6B	1/2 - 13 X 2-1/2	41	OCTAGON 0.875 X 2-1/4 - 1 RING	SPECIAL STEMS	
70	1/2 - 13 X 2-3/4	40	SQUARE 7/8 X 3.5 - 2 RINGS	86	PIPE THREAD 3/4-10 X 1-1/4 FOR PIPE O. D. 1"
C4	1/2 - 13 X 2-3/4	D5	ROUND 1 X 2.5, 3/8" CRX DRL 1" FROM BOTTOM E12	L1	LADDER STEM 9/16 X 2 BASE, 5/16 - 18 X 3-3/4 UPPER
C8	1/2 - 13 X 3-1/8	50	ROUND 7/8 X 1-7/8, CRX DRL 29/32 UP	SC	1/2 - 13 X 7/8 W/ KEY LOCK BASE FOR SHOPPING CART
C1	1/2 - 13 X 4	57	SS OCTAGON 3/4 X 2 W/3 1/4" CRX DRL	LM	0.70" X 1.72 W/ TWO 0.27" HOLE, 0.88" IN BETWEEN, FITS 7/8" ROUND TUBULAR CARTS
36	1/2 - 20 X 2-1/4	G3	SS SQUARE 7/8 X 3-1/2 - 2 RINGS	L2	PLAIN STEM 3/4 X 4
80	5/8 - 11 X 1	S7	SS ROUND 1-18 X 2-3/16 - 2 RINGS CROSS DRILLED STEM	L3	PLAIN STEM 7/8 X 4
89	5/8 - 11 X 1-1/4	43	SQUARE 9/16 X 2.92, 5/16" CRX DRL	L4	PLAIN STEM 1 X 4
81	5/8 - 11 X 1-3/4	51	OCTAGON 3/4 X 2 W/3 1/4" CRX DRL	L5	PLAIN STEM 1-3/8 X 4
38	5/8 - 11 X 2	52	OCTAGON 3/4 X 2-3/16 W/3 1/4" CRX DRL		
C5	5/8 - 11 X 2.25	55	SQUARE 7/8 X 2 CRX SEC. 1.087" 3 CRX DRILL		
39	5/8 - 11 X 2-11/16	56	OCTAGON 7/8 X 2 CRX SEC. 0.983, 3 CRX DRILL		
C2	5/8 - 11 X 4	42	OCTAGON 7/8 X 2 W/ 5/16 CRX DRL		
88	3/4 - 10 X 1	41	OCTAGON 0.875 X 2-1/4 - 1 RING		
F8	3/4 - 16 X 1 (UNF)	40	SQUARE 7/8 X 3.5 - 2 RINGS		
8Q	3/4-10 X 1-1/4	D5	ROUND 1 X 2.5, 3/8" CRX DRL 1" FROM BOTTOM E12		
87	3/4 - 10 X 1-3/4	50	ROUND 7/8 X 1-7/8, CRX DRL 29/32 UP		
T1	3/4 - 10 X 2-1/2	57	SS OCTAGON 3/4 X 2 W/ 1/4" 3 CRX DRL		
C9	3/4 - 10 X 3	7R	SS ROUNDED 3/4 X 2 W/ 17/16 3 CRX DRL		
84	3/4 - 10 X 4	G3	SS SQUARE 7/8 X 3-1/2 - 2 RINGS		
S7	3/4 - 10 X 4.25	S7	SS ROUND 1-18 X 2-3/16 - 2 RINGS		
37	3/4-10 X 5.5 (2" THREAD)				
C3	3/4 - 10 X 6				
T2	1 - 8 X 2-1/4				
C7	1 - 8 X 4				
D6	1 - 12 X 2.5				
89	M12 X 3/4 (METRIC)				
65	M12 X 2 (METRIC)				
M7	M24 X 4 (METRIC)				
S1	SS 1/2 - 13 X 4				
S2	SS 5/8 - 11 X 4				
S5	SS 3/4 - 10 X 10				
S6	SS 3/4 - 10 X 2				
S3	SS 3/4 - 10 X 6				
S4	SS 3/4 - 10 X 8				

## 8 CASTER OPTIONS

Code	Options
P3	4PSL AND PLASTIC T. G.
P4	4PSL AND TOE GUARD
XY	BLACK OXIDE
NY	CANTILEVER DUAL WHEEL
YYM	CHROME
DY	DUAL WHEEL
F4	FACE CONTACT BRAKE AND TOE GUARD
FP4	FACE CONTACT BRAKE, 4PSL AND TOE GUARD
OY	FOOD GRADE GREASE
1Y	LOW TEMP GREASE
2Y	NEOPRENE RACEWAY SEAL
YYN	NICKEL
IY	NO. SEAL, NO. GREASE, NO ZERK
3Y	PLASTIC T. G.
PH	PLASTIC TKP
L3	RACEWAY SEAL AND PLASTIC T. G.
5Y	SCREWDRIVER GROOVE AT STEM
OY	SINGLE POSITIONAL LOCK AT TRAILING
99	SS SPANNER, 4PSL, PLASTIC GUARD, SS BRAKE
T3	TLB AND PLASTIC T. G.
TP3	TLB, 4PSL AND PLASTIC T. G.
4Y	TOE GUARD
UY	UNPLATED TOP PLATE
UU	UNPLATED WHOLE CASTER
VN	VITON SEAL
PY	W/ 4 POSITIONAL LOCK
AY	W/ A CAM BRAKE
AL	W/ A CAM BRAKE AND RACEWAY SEAL
CY	W/ CAM BRAKE
CL	W/ CAM BRAKE AND RACEWAY SEAL
FY	W/ FACE CONTACT BRAKE
JY	W/ FOOT OPERATED 4 POSITIONAL LOCK
KY	W/ HIGHT TEMP GREASE
KK	W/ HIGHT TEMP GREASE AND ZERK
KL	W/ HI-TEMP SEAL AND ZERK
BY	W/ LOWER RACEWAY CAP
LY	W/ RACEWAY SEAL
SY	W/ SIDE LOCK
SP	W/ SIDE LOCK AND 4PSL
SL	W/ SIDE LOCK AND RACEWAY SEAL
HY	W/ TECH LOCK
GY	W/ THREAD GUARDS
RY	W/ THUMB SCREW BRAKE
TY	W/ TOP LOCK BRAKE
TL	W/ TOP LOCK BRAKE AND RACEWAY SEAL
VY	W/ VERTICAL BRAKE
EY	W/ ZERK AND RACEWAY SEAL
ZY	W/ ZERK AXLE
ZZ	W/ ZERK ON RACEWAY, ZERK AXLE, NO SEAL
YC	YELLOW ZINC CHROMED

## SPECIALTY CASTERS

In addition to our broad variety of casters in the following pages, Durable is very strong on developing customized casters for unique applications. Here are just some of the special casters we currently manufacture. For your unique application, please contact our sales representative.



Gray soft rubber wheels with stainless steel thread-guards and precision bearings



Durable's new *Trans-Tech* wheel offers a non-marking, chemical/oil resistant, floor protection, cushioned ride, all with a very high-tech style for your office chair or medical stand needs - (available with our FH series casters).

## UNIVERSAL HANDTRUCK CASTERS



**ACP5PUCT**  
Fits the top three convertible handtrucks



**U-CHANNEL CASTERS**

**STAINLESS DIRECTIONAL LOCK CASTERS**

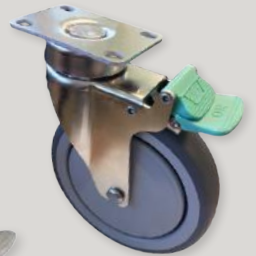

**STAINLESS TOTAL LOCK CASTERS**

## CONTAINER CASTERS

- Mobilize loaded or unloaded containers
- Fits ISO Corner Fitting of Cargo Containers of various sizes
- Load capacities range from 2,500LB to 20,000LB
- Variety of wheel selection depends on load capacity and application environment
- 'Handle' swing to lock into Corner fitting or back to unlock
- Swivel lock and wheel brakes are available



### CAUTION:

- When placing or removing casters from corners, use a fork truck to raise or lower the Corner fitting. Personnel are to stand clear of adjacent areas to avoid injury if accidentally dropped.
- Casters can allow loads to move on unlevelled surfaces and crush personnel. Lock swivel casters in towing direction and chock before detaching tow vehicle. When towing, swivels on tow-end should be unlocked after connecting tow vehicle and before starting tow.

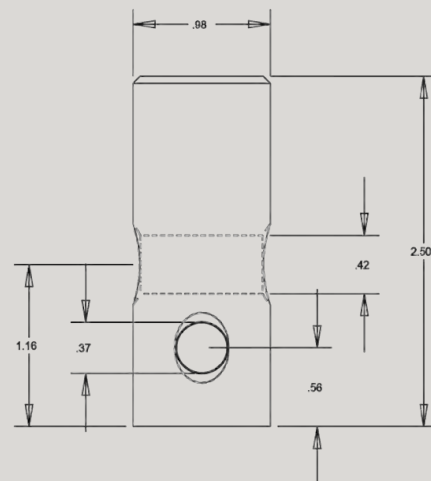



# DURABLE SUPERIOR CASTERS®

## 01, 03/04, 05/06, A5, A9 – LOW PROFILE MACHINERY SERIES – 1200 LB

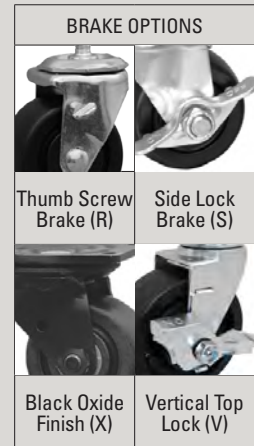

- Minimum overall height for maximum load capacity
- Bright zinc-finish as standard
- Optional finish: bright zinc, yellow zinc, black electrocoating, nickel, chrome

FASTENING OPTIONS					
Plate Code	Overall Size	Bolt Hole Pattern		Mounting Bolt Size	
06	2-3/8 X 3-5/8	1-3/4 X 2-7/8 SLOTTED 3		5/16	
11	3-1/8 X 4-1/8	1-3/4 X 2-15/16 TO 2-3/8 X 3-3/8		5/16	
12		2-3/8 X 3-3/8		5/16	
17	4 X 4-1/2	2-5/8 X 3-5/8 TO 3X3		3/8	
Stem Code	Size	Stem Type	Stem Code	Size	Stem Type
61	3/8-16 X 1	THREADED	68	1/2-13 X 1-1/2	THREADED
63	3/8-16 X 1/2		59	1/2-13 X 1-13/4	
62	3/8-16 X 1-1/2		81	5/8-11 X 1-3/4	
C6	7/16-14 X 5		88	3/4-10 X 1	
67	1/2-13 X 1		91	7/16 X 1-3/8	GRIP RING
35	1/2-13 X 1/2		ZZ	MODULAR STEM	

### 01/02, 03/04, 05/06, A5, A9 – LOW PROFILE MACHINERY SERIES – 1200 LB

Wheel Diameter	Tread Width	Wheel Type	Load Capacity	Bearing Type	Replace ** with desired fastening options.		Overall Height*	Swivel Radius			
					Swivel Caster Part #	Rigid Caster Part #					
1-5/8	5/8 X 2 1-11/16	YOKE AND AXLE/NUT			03ZZ16IZ81ZZYAN		2-7/32	1-3/8			
		POLYOLEFIN	220	PLAIN	01P0160B81**YY 03P0161B81**YY						
	2	13/16 X 2	HARD RUBBER	225	PLAIN	01HR20AB81**YY				2-7/8	1-7/8
POLYOLEFIN			250	01P020AB81**YY							
HARD RUBBER			250	05HR20AB8106YY							
5/8 X 2		THERMO-PRO™	140	PRECISION	A9TP20AI49P2YY		3	2-1/4 (WITH BRAKE)			
			POLY-PRO™	140	PRECISION	A9PP20AT49P2YY					
			POLYOLEFIN	300	PLAIN	03P0201B81**YY					
		1-3/4	MAXROK™	300	ROLLER	03MA201B29**YZ		2-7/8	1-7/8		
				300	PLAIN	05P0201B81**YY					
				400	ROLLER	05MA201B62**YZ					
2-1/2	7/8 X 2	YOKE AND AXLE/NUT			03ZZ25IZ82ZZYAN		3-1/2	2-1/2			
		POLYOLEFIN	300	PLAIN	01P025BB82**YY						
		MAXROK™	400	PLAIN	01MA25BB82**						
	1-3/4	POLYOLEFIN	300	PLAIN	03P0251B82**YY	04P0251B82**YY					
			350	ROLLER	03P0251B36**YZ	04P0251B36**Y					
		MAXROK™	400	PLAIN	03MA251B82**YY	04MA251B82**YY					
			400	ROLLER	03MA251B36**YZ	04MA251B36**YY					
			500	PRECISION	A5NX251B36**YY	A5NX251B36**YY					
	3	7/8 X 2	YOKE AND AXLE/NUT			03ZZ30IZ82ZZYAN			04ZZ30IZ82ZZYAN	4	2-1/4
			POLYOLEFIN	500	PLAIN	01P030AB82**YY					
POLY-PRO™			200	PRECISION	01PP30AB62**YY						
13/16 X 2		GRAYROK™	200	PLAIN	01RK30AI90**YY						
			300	PLAIN	01RK301B82**YY						
1-3/4		POLYOLEFIN	500	PLAIN	03P0301B90**YY	04P0301B90**YY					
			500	PRECISION	03P0301B62**YY	04P0301B62**YY					
			500	ROLLER	03P0301B08**YZ	04P0301B08**YZ					
			500	PLAIN	03MA301B90**YY	04MA301B90**YY					
		MAXROK™	500	PRECISION	03MA301B62**YY	04MA301B62**YY					
			500	ROLLER	03MA301B08**YZ	04MA301B08**YZ					
			500	ROLLER	03PH301B36**YZ	04PH301B36**YZ					
			500	ROLLER	03PH301B36**YZ	04PH301B36**YZ					

\*Reduce overall height by 1/8" for stem casters



01/02, 03/04, 05/06, A5, A9 – LOW PROFILE MACHINERY SERIES – 1200 LB

Wheel Diameter	Tread Width	Wheel Type	Load Capacity	Bearing Type	Replace ** with desired fastening options.		Overall Height*	Swivel Radius
					Swivel Caster Part #	Rigid Caster Part #		
3	7/8 X 2	POLYOLEFIN	500	PLAIN	01P031AB82**YY		4	2-7/8 (LONGER RADIUS TO ALLOW V-BRAKE)
		GRAYROK™	300	PLAIN	01RK31IB82**YY			
	13/16 X 2	POLY-PRO™	200	PRECISION	01PP31AB60**YY			
		GRAYROK™	200	PLAIN	01RK31A190**YY			
	1-3/4	POLYOLEFIN	500	PLAIN	03P031IB90**YY			
			500	PRECISION	03P031IB62**YY			
			500	ROLLER	03P031IB08**YZ			
		MAXROK™	500	PLAIN	03MA31IB90**YY			
			500	PRECISION	03MA31IB62**YY			
			500	ROLLER	03MA31IB08**YZ			
		PHENOLIC	500	ROLLER	03PH31IB36**YZ			
		YOKE AND AXLE/NUT						
		POLYOLEFIN	500	PLAIN	05P030IB90**YY		06P030IB90**YY	
			500	PRECISION	05P030IB63**YY		06P030IB63**YY	
			500	ROLLER	05P030IB08**YZ		06P030IB08**YZ	
		MAXROK™	1000	PLAIN	05MA30IB90**YY		06MA30IB90**YY	
	1000		PRECISION	05MA30IB63**YY	06MA30IB63**YY			
	1000		ROLLER	05MA30IB08**YZ	06MA30IB08**YZ			
	PHENOLIC	1000	ROLLER	05PH30IB36**YZ	06PH30IB36**YZ			
	POLYOLEFIN	500	PLAIN	05P03AIB90**YY	06P03AIB90**YY			
		500	PRECISION	05P03AIB63**YY	06P03AIB63**YY			
		500	ROLLER	05P03AIB08**YZ	06P03AIB08**YZ			
	MAXROK™	1000	PLAIN	05MA3AIB90**YY	06MA3AIB90**YY			
		1000	PRECISION	05MA3AIB63**YY	06MA3AIB63**YY			
1000		ROLLER	05MA3AIB08**YZ	06MA3AIB08**YZ				
PHENOLIC	1000	ROLLER	05PH3AIB36**YZ	06PH3AIB36**YZ				
IRONMAN™	800	PRECISION	A5NX30IB62**YY					
					4	2-3/8		

\*Reduce overall height by 1/8" for stem casters

**A9 – LOW PROFILE SWIVEL AND TOTAL LOCK CASTER – 180 LB**

NEW



- Dual raceway structure for durability as well as mobility
- Dual polyurethane or thermoplastic rubber wheels with precision bearings for easy rolling
- Various fastening options are available

FASTENING OPTIONS			
Plate Code	Overall Size	Bolt Hole Pattern	Mounting Bolt Size
P2	2-3/8" X 2-3/8"	1-1/2 X 1-1/2 TO 1-7/8	8MM
Modular Stem	Size	Stem type	Hollow Kingpin I. D.
61	3/8-16 X 1	THREADED	2" CASTER 10MM 3" CASTER 12.2MM
67	1/2-13 X 1		
53	7/16 X 7/8	GRIP RING	
91	7/16 X 1-3/8		

Wheel Diameter	Tread Width	Wheel Type	Load Capacity	Bearing Type Sealed Precision BB	Replace ** with desired fastening options.		Overall Height	Swivel Radius
					Swivel Caster Part #	Total Lock Caster Part #		
2	3/4 X 2	POLY-PRO™	135	6Q	A9PP20A16Q**YY	ATPP20A16Q**YY	2-7/8	2-3/8
		THERMO-PRO™	135	6Q	A9TP20A16Q**YY	ATTP20A16Q**YY		
3	3/4 X 2	POLY-PRO™	180	6Q	A9PP30A16Q**YY	ATPP30A16Q**YY	4	3
		THERMO-PRO™	180	6Q	A9TP30A16Q**YY	ATTP30A16Q**YY		



### MS – LIGHT DUTY SWIVEL SERIES – 150LB



MS

- Bright zinc-plated as standard, black electrocoat and nickel are available as options

FASTENING OPTIONS					
Plate Code	Overall Size		Bolt Hole Pattern		Mounting Bolt Size
P2	2-3/8 X 2-3/8		1-3/4 X 1-3/4		3/16
Stem Code	Size	Stem Type	Stem Code	Size	Stem Type
31	5/16-18 X 1	THREADED	53	7/16 X 7/8	GRIP RING



MC

Wheel Diameter	Tread Width	Wheel Type	Load Capacity	Bearing Type	Replace ** with desired fastening options.	Overall Height	Swivel Radius
Swivel Caster Part #						4	2-11/16
MS30BI**YY (BLACK FINISH)							
MC30BI**YY (POLISHED BRIGHT CHROME)							

### 8A/8R – LIGHT DUTY SWIVEL SERIES – 150LB



8A

- Double ball raceway swivel
- 1/4" axle
- NSF listed
- Bright zinc-plated as standard, Black electrocoat and Nickel available as options

FASTENING OPTIONS					
Plate Code	Overall Size		Bolt Hole Pattern		Mounting Bolt Size
P2	2-3/8 X 2-3/8		1-3/4 X 1-3/4		3/16
Stem Code	Size	Stem Type	Stem Code	Size	Stem Type
31	5/16-18 X 1	THREADED	53	7/16 X 7/8	GRIP RING

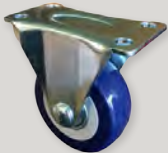

8R

Wheel Diameter	Tread Width	Wheel Type	Load Capacity	Bearing Type	Replace ** with desired fastening options.	Overall Height	Swivel Radius	
				Swivel Caster Part #		Rigid Caster Part #		
3	7/8	POLY-PRO™	150	PRECISION	8APP30BL81**YY	8RPP30BL81**YY	4	2-11/16

08 – LIGHT DUTY SERIES – 110LB



- Dual raceway offers improved swiveling action and durability
- Variety of fastenings
- 1/4" axle
- NSF listed
- Bright zinc-plated as standard, black electrocoat and nickel, yellow zinc are also available

FASTENING OPTIONS					
Plate Code	Overall Size		Bolt Hole Pattern		Mounting Bolt Size
01	1-1/4 X 2-1/16		13/16 X 1-9/16		3/16
00	1-1/2 X 2-21/32		15/16 X 2-1/8 TO 1 X 2-1/8		1/4
09	1-1/2 X 2-1/8		15/16 X 1-5/8		3/16
08	1-3/4 X 3		1 X 2-3/16 TO 2-5/16		5/16
Stem Code	Size	Stem Type	Stem Code	Size	Stem Type
83	1/4-30 X 1/2	THREADED	68	1/2-13 X 1-1/2	THREADED
32	5/16-18 X 3/4	THREADED	53	7/16 X 7/8	GRIP RING
31	5/16-18 X 1	THREADED	54	3/8 X 1	GRIP RING
34	5/16-18 X 1-1/2	THREADED	90	7/16 X 1-3/16	GRIP RING
63	3/8-16 X 1/2	THREADED	91	7/16 X 1-3/8	GRIP RING
61	3/8-16 X 1	THREADED	97	7/16 X 2	GRIP RING
58	3/8-16 X 1-1/4	THREADED	L1	5/16 X 5-3/4 W/ THREADS	LADDER STEM (SPRING NOT INCLUDED)
62	3/8-16 X 1-1/2	THREADED	L3	1/2 X 4-1/2 PLAIN	LADDER STEM (SPRING NOT INCLUDED)
33	7/16-14 X 1-1/2	THREADED	WS	5/16"	WOOD STEM

Wheel Diameter	Tread Width	Wheel Type	Load Capacity	Bearing Type	Replace ** with desired fastening options.	Overall Height	Swivel Radius
					Swivel Caster Part #		
1-5/8	11/16	POLYOLEFIN	60	PLAIN	08P016WB80**YY	2-5/16	1-5/8
		SOFT RUBBER	60		08SR16WI80**YY		
		HARD RUBBER	60		08HR16WB80**YY		
2	13/16	YOKE AND AXLE/NUT			08ZZ20AZ80**YAN	2-5/8	1-13/16
		HARD RUBBER	80	PLAIN	08HR20AB80**YY		
		POLYOLEFIN	80	PLAIN	08P020AB80**YY		
		POLY-PRO™	80	PLAIN	08PP20AT80**YY		
			80	PRECISION	08PP20AL41**YY		
		SOFT RUBBER	70	PLAIN	08SR20AB80**YY		
		GRAY SOFT RUBBER	70	PLAIN	08SR20AI80**YY		
		THERMO-PRO™	70	PLAIN	08TP20AT80**YY		
2-1/2	13/16	YOKE AND AXLE/NUT			08ZZ25AZ80**YAN	3-1/8	2-1/16
		HARD RUBBER	100	PLAIN	08HR25AB80**YY		
		POLYOLEFIN	110	PLAIN	08P025AB80**YY		
		POLY-PRO™	100	PLAIN	08PP25AT80**YY		
			100	PRECISION	08PP25AL41**YY		
		SOFT RUBBER	80	PLAIN	08SR25AB80**YY		
		GRAY SOFT RUBBER	80	PLAIN	08SR25AI80**YY		
		THERMO-PRO™	80	PLAIN	08TP25AT80**YY		
3	13/16	YOKE AND AXLE/NUT			08ZZ30AZ80**YAN	3-5/8	2-3/8
		HARD RUBBER	110	PLAIN	08HR30AB80**YY		
		POLYOLEFIN	110	PLAIN	08P030AB80**YY		
		POLY-PRO™	110	PLAIN	08PP30AT80**YY		
			110	PLAIN	08PP30AB80L1YY		
			110	PRECISION	08PP30AL41**YY		
		SOFT RUBBER	100	PLAIN	08SR30AB80**YY		
		GRAY SOFT RUBBER	100	PLAIN	08SR30AI80**YY		

WHEEL TYPE OPTIONS						
Poly-Pro™	Thermo-Pro™	Gray Soft Rubber	Soft Rubber	Hard Rubber	Polyolefin	Ask your rep about our gray on black (AH) wheel color option.

BRAKE OPTIONS	
Side Brake (S)	Tech Lock Pedal Brake (H)



# DURABLE SUPERIOR CASTERS®

## 11/12 – GENERAL DUTY SERIES – 500 LB



### TOP PLATE SPECIFICATIONS AND AXLE SIZES

Wheel Diameter	Caster Type	Plate Code	Overall Size	Bolt Hole Pattern	Mounting Bolt Size	Axle Size
2	SWIVEL	02	1-7/8 X 2-9/16	15/16 X 2-1/8	1/4	1/4
	RIGID	00	1-1/2 X 2-21/32	15/16 X 2-1/8		1/4
2-1/2	SWIVEL	07	2-5/8 X 3-11/16	1-3/4 X 3		5/16
	RIGID	03	2-1/4 X 4-7/16	1-1/16 X 3-1/2		
3	SWIVEL	12	3-1/8 X 4-1/8	2-3/8 X 3-3/8		3/8
	RIGID	12	3-1/8 X 4-1/2	2-3/8 X 3-3/8		
		04	2-1/4 X 5-1/8	1-3/16 X 4		
4	SWIVEL	18	4 X 5	3 X 4		3/8
	RIGID	15	3-1/4 X 6-1/4	1-3/4 X 5		

### BRAKE OPT.



Side Brake (S)



2"

11



12



2-1/2"

11



12



3"

11



12



3"

11

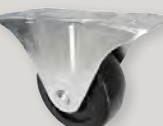

12

- Deeply embossed single ball raceway
- Standard zinc-plated finish

Wheel Dia.	Tread Width	Wheel Type	Load Cap.	Bearing Type	11 Series Swivel Caster Part #	12 Series Rigid Caster Part #	+ Color	Overall Height	Swivel Radius	
2	15/16	YOKE AND AXLE/NUT			11ZZ20CZ8002YY	12ZZ20CZ8000YY	GRAY BLACK	2-7/16	1-3/4	
		HARD RUBBER	100	PLAIN	11HR20CB8002YY	12HR20CB8000YY				
		POLYOLEFIN	100	PLAIN	11PO20CB8002YY	12PO20CB8000YY				
		H. D. POLYOLEFIN	125	PLAIN	11HP20CB8002YY	12HP20CB8000YY				
		POLY-PRO™	75	PLAIN	11PP20BT8002YY	12PP20BT8002YY				
		SINTERED IRON	150	PLAIN	11SI20CS8002YY	12SI20CS8000YY				
		SEMI-STEEL	150	PLAIN	11SS20CS8002YY	12SS20CS8000YY				
2-1/2	1-1/16	YOKE AND AXLE/NUT			11ZZ25CZ8107YY	12ZZ25CZ8103YY	GRAY BLACK	3-1/4	2-3/8	
		HARD RUBBER	175	PLAIN	11HR25CB8107YY	12HR25CB8103YY				
		POLYOLEFIN	125	PLAIN	11PO25CB8107YY	12PO25CB8103YY				
		POLY-PRO™	150	PRECISION	11PP25DM4107YY	12PP25DM4107YY				
		SINTERED IRON	200	PLAIN	11SI25DS8107YY	12SI25DS8103YY				
		SEMI-STEEL	200	PLAIN	11SS25CS8107YY	12SS25CS8103YY				
		SOFT RUBBER	150	PLAIN	11SR25CB8107YY	12SR25CB8103YY				
3	1-1/4	YOKE AND AXLE/NUT			11ZZ30GZ8212YY	12ZZ30GZ82++YY	T, Y K, W A, D, I, K, S T, Y K, W T, Y B, Z J, Z B, E	3-1/2	2-1/4	
		SOFT RUBBER	175	PLAIN	11SR30GB8212YY	12SR30GB82++YY				
			200	BALL	11SR30GB4212YY	12SR30GB421++Y				
		NOMADIC™	200	ANNULAR	11NM30GI4312YY	12NM30GI43++YY				
		THERMO-PRO™	200	PRECISION		11TP30GI4412YY				12TP30GI44++YY
						11TP30G+4712YY				12TP30G+47++YY
		POLY-PRO™	210	PRECISION	BALL	11PP30G+4212YY				12PP30G+42++YY
						11PP30G+4412YY				12PP30G+44++YY
						11PP30G+4712YY				12PP30G+47++YY
						11PP30G+5512YY				12PP30G+55++YY
		POLY-PRO™	210	SLEEVE		11PP30G+9012YY				12PP30G+90++YY
						11PP30G+9012YY				12PP30G+90++YY
		POLY-PRO™	210	ANNULAR	11PM30GM4312YY	12PM30GM43++YY				
		DURALASTOMER™		SLEEVE	11SU30GL9012YY	12SU30GL90++YY				
		POLYON AL™		ANNULAR	11PA30GL4312YY	12PA30GL43++YY				
		HARD RUBBER	300	PLAIN		11HR30GB4212YY				12HR30GB42++YY
						11HR30GB8212YY				12HR30GB82++YY
		POLYOLEFIN	300	PLAIN		11PO30G+8212YY				12PO30G+82++YY
						11PO30G+9012YY				12PO30G+90++YY
		H.D. POLYOLEFIN	300	PLAIN		11HP30G+8212YY				12HP30GE82++YY
	11NY30GE8212YY				12NY30GE82++YY					
NYLON	300	PRECISION		11NY30GE4412YY	12NY30GE44++YY					
				11SS30GS8212YY	12SS30GS82++YY					
SEMI-STEEL	300	SLEEVE		11SS30GS9012YY	12SS30GS90++YY					
				11SI30GS8212YY	12SI30GS82++YY					
SINTERED IRON	300	PLAIN		11VG30GT8212YY	12VG30GT82++YY					
				11VG30GT9012YY	12VG30GT90++YY					
V-GROOVE	300	SLEEVE		11PH30GB9912YY	12PH30GB99++YY					
				11PH30GB0312Y	12PH30GB0312Y					
PHENOLIC	300	ROLLER		11PH30GB9912YY	12PH30GB99++YY					
				11PH30GB0312Y	12PH30GB0312Y					
4	1-1/2	YOKE AND AXLE/NUT			11ZZ40HZ8218YY	12ZZ40HZ8215YY	D, K, U G, V N, R	5	3-1/4	
		SOFT RUBBER	240	PLAIN	11SR40HB8218YY	12SR40HB8215YY				
		THERMO-PRO™	325	ROLLER	11TP40HI0318YZ	12TP40HI0315YZ				
		POLY-PRO™	400	ROLLER	11PP40H+0318YZ	12PP40H+0318YZ				
		POLYON™	500	ROLLER	11PU40H+0318YZ	12PU40H+0315YZ				
		POLYON AL™	500	ROLLER	11PA40H+0318YZ	12PA40H+0315YZ				
		HARD RUBBER	400	PLAIN		11HR40HB8218YY				12HR40HB8215YY
						11PO40HB0318YZ				12PO40HB0315YZ
		POLYOLEFIN	400	ROLLER		11PH40HB9018YY				12PH40HB9015YY
						11PH40HB0318YZ				12PH40HB0315YZ
		PHENOLIC	500	ROLLER		11PH40HB9018YY				12PH40HB9015YY
						11PH40HB0318YZ				12PH40HB0315YZ
		SEMI-STEEL	500	SLEEVE		11SS40HS9018YY				12SS40HS9015YY
						11SS40HS0318YZ				12SS40HS0315YZ
		SINTERED IRON	400	PLAIN		11SI40HS8218YY				12HS40HS8215YY
	11SI40HS8218YY				12HS40HS8215YY					

09/10/T2 – LIGHT DUTY INSTITUTIONAL SERIES – 175 LB

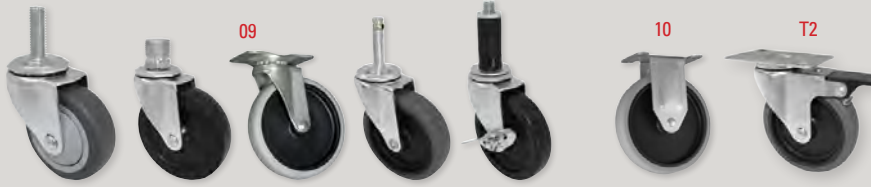

- 1" wide light medium duty wheels
- Double ball raceway swivel
- 5/16" axle and nut
- NSF Listed
- Bright zinc-plated as standard, black electrocoat and nickel are available as options

FASTENING OPTIONS					
Plate Code	Overall Size		Bolt Hole Pattern		Mounting Bolt Size
06	2-3/8 X 3-5/8		1-3/4 X 2-7/8 SLOTTED 3		5/16
08	1-3/4 X 3		1 X 2-3/16 SLOTTED TO 2-5/16		
S8	1-3/4 X 3		1 X 2-1/8 SLOTTED TO 2-5/16		1/4
P2	2-3/8 X 2-3/8		1-3/4 X 1-3/4		3/16
Stem Code	Size	Stem Type	Stem Code	Size	Stem Type
31	5/16-18 X 2	THREADED	71	0.720-0.851	EXPENDABLE ADAPTER FOR ROUND PIPE
60	3/8-16 X 3/4		72	0.852-0.927	
61	3/8-16 X 1		7S	0.920-.0980	
62	3/8-16 X 1-1/2		73	0.928-1.029	
64	3/8-16 X 1-3/8		7A	1.020-1.100	
79	7/16 X 2-1/4		74	1.030-1.140	
33	7/16-14 X 1-1/2		75	1.360-1.425	
66	1/2-13 X 3/4		76	1.426-1.589	
67	1/2-13 X 1		77	1.790-1.850	
68	1/2-13 X 1-1/2		R1	0.720-0.851	
70	1/2-13 X 2-3/4	R2	0.852-0.927		
86	1-1/16 X 3/4	PIPE THREAD (NPT34)	R3	0.928-1.029	
53	7/16 X 7/8	GRIP RING	R4	1.030-1.140	
90	7/16 X 1-3/16		R5	1.360-1.425	
91	7/16 X 1-3/8		R6	1.426-1.589	
49	7/16 X 1-3/4		R7	1.790-1.850	
97	7/16 X 2		L1	5/16 X 5-3/4	LADDER STEM (NOT INCLUDING SPRING)
			42	7/8	OCTAGON W/ 5/16 CROSS DRILLED HOLE

WHEEL TYPE OPTIONS		
Soft Rubber	Hard Rubber	Polyolefin

WHEEL COLOR OPTIONS		
Thermo-Pro™		
Flat Tread		
A	I	T

OTHER OPT.	
Rivet Axle	J

BRAKE OPTIONS		
Side Brake (S)	Tech Brake (HY)	Vertical Lock

Wheel Diameter	Tread Width	Wheel Type	Load Capacity	Bearing Type	Replace ** with desired fastening options.			+ Color	Overall Height	Swivel Radius		
					09 Series Swivel Caster Part #	10 Series Rigid Caster Part #	T2 Total-Lock Swivel Caster Part #					
1-5/8	7/8	YOKE AND AXLE/NUT		PRECISION	09ZZ16DZ81ZZYAN	10ZZ16DZ81ZZYAN			2-7/16	1-9/16		
		THERMO-PRO™	80		09TP16DI41**YY	10TP16DI41**YY						
		POLY-PRO™	100		09PP16DL41**YY	10PP16DL41**YY						
2	1	YOKE AND AXLE/NUT		PRECISION	09ZZ20DZ81ZZYAN	10ZZ20DZ81ZZYAN			3	2-3/32		
		THERMO-PRO™	110		09TP20DI41**YY	10TP20DI41**YY						
		POLY-PRO™	150		09PP20DL41**YY	10PP20DL41**YY						
2-1/2	1	YOKE AND AXLE/NUT		PRECISION	09ZZ25DZ81ZZYAN	10ZZ25DZ81ZZYAN			3-1/4	2-11/32		
		THERMO-PRO™	110		09TP25DI41**YY	10TP25DI41**YY						
		POLY-PRO™	150		09PP25DL41**YY	10PP25DL41**YY						
3	1	YOKE AND AXLE/NUT		PRECISION	09ZZ30DZ81ZZYAN	10ZZ30DZ81ZZYAN	T2ZZ30DZ81ZZYAN			3-5/8	2-5/8	
		HARD RUBBER	125		PLAIN	09HR30DB81**YY	10HR30DB81**YY					T2HR30DB81**YY
		POLYOLEFIN	175		PLAIN	09P030DB81**YY	10P030DB81**YY					T2P030DB81**YY
		POLY-PRO™	125		PLAIN	09PP30DT81**YY	10PP30DT81**YY					T2PP30DT81**YY
			150		PRECISION	09PP30DI41**YY	10PP30DM41**YY					T2PP30DM41**YY
		SOFT RUBBER	100		PLAIN	09SR30DB81**YY	10SR30DB81**YY					T2SR30DB81**YY
THERMO-PRO™	120	PLAIN	09TP30D+81**YY	10TP30D+81**YY	T2TP30D+81**YY	H, T						
		PRECISION	09TP30DI41**YY	10TP30DI41**YY	T2TP30DI41**YY							
4	1	YOKE AND AXLE/NUT		PRECISION	09ZZ40DZ81ZZYAN	10ZZ40DZ81ZZYAN	T2ZZ40DZ81ZZYAN			4-5/8	3-1/4	
		HARD RUBBER	140		PLAIN	09HR40DB81**YY	10HR40DB81**YY					T2HR40DB81**YY
		POLYOLEFIN	175		PLAIN	09P040DB81**YY	10P040DB81**YY					T2P040DB81**YY
		POLY-PRO™	140		PLAIN	09PP40DT81**YY	10PP40DT81**YY					T2PP40DT81**YY
			150		PRECISION	09PP40DI41**YY	10PP40DM41**YY					T2PP40DM41**YY
		SOFT RUBBER	125		PLAIN	09SR40DB81**YY	10SR40DB81**YY					T2SR40DB81**YY
THERMO-PRO™	125	PLAIN	09TP40D+81**YY	10TP40D+81**YY	T2TP40D+81**YY	H, T						
		PRECISION	09TP40DI41**YY	10TP40DI41**YY	T2TP40DI41**YY							
5	1	YOKE AND AXLE/NUT		PLAIN	09ZZ50DZ81ZZYAN	10ZZ50DZ81ZZYAN	T2ZZ50DZ81ZZYAN			5-5/8	3-7/8	
		HARD RUBBER	145		PLAIN	09HR50DB81**YY	10HR50DB81**YY					T2HR50DB81**YY
		POLYOLEFIN	175		PLAIN	09P050DB81**YY	10P050DB81**YY					T2P050DB81**YY
		POLY-PRO™	145		PLAIN	09PP50DT81**YY	10PP50DT81**YY					T2PP50DT81**YY
			125		PLAIN	09SR50DB81**YY	10SR50DB81**YY					T2SR50DB81**YY
		THERMO-PRO™	135		PLAIN	09TP50D+81**YY	10TP50D+81**YY					T2TP50D+81**YY

\*Reduce overall height by 3/32' for stem casters



## 23/24 – LIGHT MEDIUM DUTY, ECONOMY SERIES – 200 LB



- Featuring 1-1/4" wide light medium duty wheels
- Double ball raceway swivel
- 3/8" axle and nut
- NSF listed
- Bright zinc-plated as standard, black electrocoat and nickel are available as options

FASTENING OPTIONS					
Plate Code	Overall Size		Bolt Hole Pattern		Mounting Bolt Size
06	2-3/8 X 3-5/8		1-3/4 X 2-7/8 SLOTTED 3		5/16
08	1-3/4 X 3		1 X 2-3/16 SLOTTED TO 2-5/16		
11	3-1/8 X 4-1/8		1-3/4 X 2-15/16 TO 2-3/8 X 3-3/8		
17	4 X 4-1/2		2-5/8 X 3-5/8 TO 3X3		3/8
Stem Code	Size	Stem Type	Stem Code	Size	Stem Type
63	3/8-16 X 1/2	THREADED	66	1/2-13 X 3/4	THREADED
60	3/8-16 X 3/4		67	1/2-13 X 1	
61	3/8-16 X 1		68	1/2-13 X 1-1/2	
62	3/8-16 X 1-1/2		91	7/16 X 1-3/8	GRIP RING
			9B	7/16 X 1	

BRAKE OPTIONS	
Side Brake (S)	Top Lock Brake (T)

WHEEL TYPE OPTIONS										
Hard Rubber	Soft Rubber	Cushion Ride™ (A)	Cushion Ride™ (I)	Rubber on Aluminum	Nomadic™	Polymadic™	Dura Lastomer®	Poly-AL™ (L)	Polyolefin (B)	Polyolefin Donut (Z)
Blue Nomadic	Polyolefin Donut (J)	H. D. Polyolefin	Nylon	Phenolic	H. T. Phenolic High Temp	BrimSton® High Temp	Sterollizer AL® High Temp	Semi-Steel	Sintered Iron	V-Groove

OTHER OPTIONS	
Thread Guards	G
High Temp Grease	K
Zerk Axle	Z

WHEEL COLOR OPTIONS															
Thermo-Pro™					Poly-Pro™										
Flat Tread				Round	Flat Tread										Round
A	B	I	T	Y	A	D	I	K	P	S	T	V	W	Y	

### 23/24 – LIGHT MEDIUM DUTY, ECONOMY SERIES – 200 LB

Wheel Diameter	Tread Width	Wheel Type	Load Capacity	Bearing Type	Replace ** with desired fastening options.		+ Color	Overall Height	Swivel Radius	
					23 Series Swivel Caster Part #	24 Series Rigid Caster Part #				
3	1-1/4	YOKE ONLY				23ZZ30GZ82**YAN	24ZZ30GZ82**YAN		3-3/4	2-1/2
		SOFT RUBBER	200	PLAIN	23SR30GB82**YY	24SR30GB82**YY				
				BALL	23SR30GB42**YY	24SR30GB42**YY				
				DELRIN	23NM30GI5A**YY	24NM30GI5A**YY				
		NOMADIC™	200	ANNULAR	23NM30GI43**YY	24NM30GI43**YY				
				PRECISION	23TP30GI44**YY	24TP30GI44**YY				
		THERMO-PRO™	200		23TP30G+47**YY	24TP30G+47**YY	T, Y			
				SLEEVE	23TP30G+90**YY	24TP30G+90**YY				
				ANNULAR	23EL30GI43**YY	24EL30GI43**YY				
		ELEMENT™	200							

\*Reduce overall height 3/32" for stem casters

23/24 – LIGHT MEDIUM DUTY, ECONOMY SERIES – 200 LB

Wheel Diameter	Tread Width	Wheel Type	Load Capacity	Bearing Type	Replace ** with desired fastening options.		+ Color	Overall Height	Swivel Radius	
					23 Series Swivel Caster Part #	24 Series Rigid Caster Part #				
3	1-1/4	YOKE ONLY				23ZZ20GZ8267YAN	24ZZ50GZ8267YAN		3-1/8	2-1/2
		POLYOLEFIN	200	PLAIN	23P025GB8267YY	24P025GB8267YY	B			
		POLY-PRO™	200	BALL	23PP30G+42**YY	24PP30G+42**YY	K, W			
				PRECISION	23PP30G+44**YY	24PP30G+44**YY	A, D, I, K, S			
					23PP30G+47**YY	24PP30G+47**YY	T, Y			
				DELRIN	23PP30G+55**YY	24PP30G+55**YY	K, W			
				SLEEVE	23PP30G+90**YY	24PP30G+90**YY	T, Y			
		POLYMAC™	200	DELRIN	23PM30GM5A**YY	24PM30GM5A**YY				
				ANNULAR	23PM30GM43**YY	24PM30GM43**YY				
		HARD RUBBER	200	BALL	23HR30GB42**YY	24HR30GB42**YY				
				PLAIN	23HR30GB82**YY	24HR30GB82**YY				
		POLYOLEFIN	200	PLAIN	23P030G+82**YY	24P030G+82**YY	B, Z			
				SLEEVE	23P030G+90**YY	24P030G+90**YY	J, Z			
				BALL	23P030GZ42**YY	24P030GZ42**YY				
		H. D. POLYOLEFIN	200	PLAIN	23HP30G+82**YY	24HP30G+82**YY	B, E			
				TOP HEAD	23PH30GB99**YY	24PH30GB99**YY				
CONDUCTIVE TPR	200	PRECISION	23CN30GH44**YY	24CN30GH44**YY						
CONDUCTIVE SR	200	BALL	23CT30GB42**YY	24CT30GB42**YY						
GRAYROK™	200	PLAIN	23RK30GI83**YY	24RK30GI83**YY						
4	1-1/4	YOKE ONLY				23ZZ40GZ82**YAN	24ZZ40GZ82**YAN		4-5/8	3-1/4
		SOFT RUBBER	200	PLAIN	23SR40GB82**YY	24SR40GB82**YY				
		NOMADIC™	200	BALL	23SR40GB42**YY	24SR40GB42**YY				
				DELRIN	23NM40GI5A**YY	24NM40GI5A**YY				
		THERMO-PRO™	200	ANNULAR	23NM40GI43**YY	24NM40GI43**YY				
				PRECISION	23TP40GI44**YY	24TP40GI44**YY				
					23TP40G+47**YY	24TP40G+47**YY	T, Y			
		ELEMENT™	200	SLEEVE	23TP40G+90**YY	24TP40G+90**YY				
				ANNULAR	23EL40GI43**YY	24EL40GI43**YY				
		POLY-PRO™	200	BALL	23PP40G+42**YY	24PP40G+42**YY	W, K, P			
				PRECISION	23PP40G+44**YY	24PP40G+44**YY	A, D, I, S, C			
					23PP40G+47**YY	24PP40G+47**YY	T, Y			
		SLEEVE	200		23PP40G+90**YY	24PP40G+90**YY				
				DELRIN	23PP40G+55**YY	24PP40G+55**YY				
		POLYMAC™	200	DELRIN	23PM40GM5A**YY	24PM40GM5A**YY				
				ANNULAR	23PM40GM43**YY	24PM40GM43**YY				
HARD RUBBER	200	PLAIN	23HR40GB82**YY	24HR40GB82**YY						
		BALL	23HR40GB42**YY	24HR40GB42**YY						
POLYOLEFIN	200	SLEEVE	23P040G+90**YY	24P040G+90**YY	J, Z					
		PLAIN	23P040G+82**YY	24P040G+82**YY	B, Z					
		BALL	23P040GZ42**YY	24P040GZ42**YY						
H. D. POLYOLEFIN	200	PLAIN	23HP40G+82**YY	24HP40G+82**YY	B, E					
		TOP HEAD	23PH40GB99**YY	24PH40GB99**YY						
CONDUCTIVE	200	PRECISION	23CN40GH44**YY	24CN40GH44**YY						
EPOXY	200	SLEEVE	23OV40GQ90**YY	24OV40GQ90**YY						
5	1-1/4	YOKE ONLY				23ZZ50GZ82**YAN	24ZZ50GZ82**YAN		5-5/8	4-3/16
		SOFT RUBBER	200	PLAIN	23SR50GB82**YY	24SR50GB82**YY				
		NOMADIC™	200	BALL	23SR50GB42**YY	24SR50GB42**YY				
				DELRIN	24NM50GI5A**YY	24NM50GI5A**YY				
		THERMO-PRO™	200	ANNULAR	23NM50GI43**YY	24NM50GI43**YY				
				PRECISION	23TP50GI44**YY	24TP50GI44**YY				
					23TP50GI47**YY	24TP50G+47**YY				
		SLEEVE	200		23TP50G+90**YY	24TP50G+90**YY	T, Y			
				ANNULAR	23EL50GI43**YY	24EL50GI43**YY				
		POLY-PRO	200	BALL	23PP50G+42**YY	24PP50G+42**YY	C, K, P, W			
				PRECISION	23PP50G+44**YY	24PP50G+44**YY	I, A, D, S			
					23PP50G+47**YY	24PP50G+47**YY	T, Y			
		SLEEVE	200		23PP50G+90**YY	24PP50G+90**YY				
				DELRIN	23PP50G+55**YY	24PP50G+55**YY	C, K, P, W			
		POLYMAC™	200	DELRIN	23PM50GM5A**YY	24PM50GM5A**YY				
				ANNULAR	23PM50GM43**YY	24PM50GM43**YY				
HARD RUBBER	200	PLAIN	23HR50GB82**YY	24HR50GB82**YY						
		BALL	23HR50GB42**YY	24HR50GB42**YY						
POLYOLEFIN	200	PLAIN	23P050G+82**YY	24P050G+82**YY						
		SLEEVE	23P050G+90**YY	24P050G+90**YY	J, Z					
		BALL	23P050GZ42**YY	24P050GZ42**YY						
H. D. POLYOLEFIN	200	PLAIN	23HP50G+82**YY	24HP50G+82**YY	B, E					
		TOP HEAD	23PH50GB99**YY	24PH50GB99**YY						
CONDUCTIVE	200	PRECISION	23CN50GH44**YY	24CN50GH44**YY						

\*Reduce overall height 3/32" for stem casters

## 13/14 – LIGHT MEDIUM DUTY, PLATE MOUNT SERIES – 350 LB



BRAKE OPTIONS			
Cam Brake (C)	Tech Lock Pedal Brake (H)	Top Lock Brake (T)	TPK Brake Kit

OTHER OPTIONS			
	Spring clip, quick change plate. For use with 06 plate. Part # CP06-01	Thread Guards	G
		High Temp Grease	K
For more info, see page 167		Zerk Axle	Z

- Featuring 1-1/4" wide light medium duty wheels
- Double ball raceway swivel
- 3/8" axle and nut
- NSF listed
- Bright zinc-plated as standard, black electrocoat and nickel are available as options

FASTENING OPTIONS			
Plate Code	Overall Size	Bolt Hole Pattern	Mounting Bolt Size
06	2-3/8 X 3-5/8	1-3/4 X 2-7/8 SLOTTED 3	5/16
	PLATE FEATURES ADDITIONAL MOUNTING HOLES FOR USE ON ALUMINUM STRUCTURAL FRAMING, MODULAR CARTS & WORK STATIONS. TWO 5/16" HOLES CENTERED AT 3.22 (BETWEEN OTHER HOLES, LONG WAY)		
MS	3-1/8 X 3-3/4	1-5/8 X 3 TO 2-5/16 X 3-1/8	3/8
11	3-1/8 X 4-1/8	1-3/4 X 2-15/16 TO 2-3/8 X 3-3/8	
17	4 X 4-1/2	2-5/8 X 3-5/8 TO 3 X 3	

WHEEL COLOR OPTIONS															
Thermo-Pro™					Poly-Pro™										
Flat Tread				Round	Flat Tread										Round
A	B	I	T	Y	A	D	I	K	P	S	T	V	W	Y	

### 13/14 LIGHT – MEDIUM DUTY, PLATE MOUNT SERIES – 350 LB

Wheel Dia.	Tread Width	Wheel Type	Load Capacity	Bearings Type	13 Series Swivel Caster Part #	14 Series Rigid Caster Part #	O. A. H.	Swivel Radius	Color	
2-1/2	1-1/4	YOKE AND AXLE/NUT				13ZZ25GZ82"YAN	14ZZ25GZ82"YAN	3-9/16	2-9/16	
		SOFT RUBBER	175	PLAIN	13SR25GB82"YY	14SR25GB82"YY				
		THERMO-PRO™	250	PRECISION	13TP25GI44"YY	14TP25GI44"YY				
				BALL	13TP25GB42"YY	14TP25GB42"YY				
		POLYOLEFIN	250	PLAIN	13P025GB82"YY	14P025GB82"YY				
		HARD RUBBER	250	BALL	13PP25G+42"YY	14PP25G+42"YY				
3	1-1/4	YOKE AND AXLE/NUT				13ZZ30GZ82"YAN	14ZZ30GZ82"YAN	4-1/8	2-15/16	
		SOFT RUBBER	300	PLAIN	13SR30GB82"YY	14SR30GB82"YY				
				BALL	13SR30GB42"YY	14SR30GB42"YY				
		NOMADIC™	300	DELTRIN	13NM30GI5A"YY	14NM30GI5A"YY				
				ANNULAR	13NM30GI43"YY	14NM30GI43"YY				
		CONDUCTIVE TPR	200	PRECISION	13CN30GH44"YY	14CN30GH44"YY				
		CONDUCTIVE SR	250	BALL	13CT30GB42"YY	14CT30GB42"YY				
		THERMO-PRO™	210	PRECISION	13TP30GI44"YY	14TP30GI44"YY				
				SLEEVE	13TP30G+47"YY	14TP30G+47"YY				
		ELEMENT™	210	ANNULAR	13EL30GI43"YY	14EL30GI43"YY				
				BALL	13PP30G+42"YY	14PP30G+42"YY				
		POLY-PRO™	300	PRECISION	13PP30G+44"YY	14PP30G+44"YY				
					13PP30G+47"YY	14PP30G+47"YY				
				DELTRIN	13PP30G+55"YY	14PP30G+55"YY				
					SLEEVE	13PP30G+90"YY	14PP30G+90"YY			
POLYMAC™	300	ANNULAR	13PM30GM43"YY	14PM30GM43"YY						
DURALASTOMER™	300	SLEEVE	13SU30GL90"YY	14SU30GL90"YY						
POLYON AL™	350	ANNULAR	13PA30GL43"YY	14PA30GL43"YY						
HARD RUBBER	300	BALL	13HR30GB42"YY	14HR30GB42"YY						
		PLAIN	13HR30GB82"YY	14HR30GB82"YY						
GRAYROK™	300	PLAIN	13RK30GI82"YY	14RK30GI82"YY						
		BALL	13P030G+82"YY	14P030G+82"YY						
3	1-1/4	POLYOLEFIN	250	PLAIN	13P030G+82"YY	14P030G+82"YY	4-1/8	2-15/16	B, Z	
			300	SLEEVE	13P030G+90"YY	14P030G+90"YY			J, Z	
				BALL	13P030GZ42"YY	14P030GZ42"YY				



13/14 LIGHT – MEDIUM DUTY, PLATE MOUNT SERIES – 350 LB

Wheel Dia.	Tread Width	Wheel Type	Load Capacity	Bearings Type	13 Series Swivel Caster Part #	14 Series Rigid Caster Part #	O. A. H.	Swivel Radius	Color	
3	1-1/4	H. D. POLYOLEFIN	300	PLAIN	13HP30G+82**YY	14HP30G+82**YY	4-1/8	2-15/16		
		NYLON	300	SLEEVE	13NY30GE90**YY	14NY30GE90**YY				
		PHENOLIC	300	PRECISION	13NY30GE47**YY	14NY30GE47**YY				
		H. T. PHENOLIC	200	TOP HEAD	13PH30GB99**YY	14PH30GB99**YY				
		BRIMSTONE®	350	S.S. TOP HEAD	13HT30GQ97**YY	14HT30GQ97**YY				
		SEMI-STEEL	350	S.S. TOP HEAD	13GN30GQ97**YY	14GN30GQ97**YY				
		SINTERED IRON	350	PLAIN	13SS30GS82**YY	14SS30GS82**YY				
	V-GROOVE	350	SLEEVE	13SS30GS90**YY	14SS30GS90**YY					
	1-1/2	PHENOLIC	350	PLAIN	13SI30GS82**YY	14SI30GS82**YY				
					ROLLER	13PH30GB90**YY				14PH30GB90**YY
3-1/2	1-1/4	YOKE AND AXLE/NUT				13ZZ35GZ82**YAN	14ZZ35GZ82**YAN	4-5/8	3-3/16	T, Y  K, W, P A, D, I, K, S T, Y K, W, P
		SOFT RUBBER	350	PLAIN	13SR35GB82**YY	14SR35GB82**YY				
		RUBBER/ALU	250	ANNULAR	13RA35GI43**YY	14RA35GI43**YY				
		NOMADIC™	300	DELTRIN	13NM35GI5A**YY	14NM35GI5A**YY				
		THERMO-PRO™	230	PRECISION	ANNULAR	13NM35GI43**YY	14NM35GI43**YY			
					PRECISION	13TP35GI44**YY	14TP35GI44**YY			
		ELEMENT™	220	ANNULAR	PRECISION	13TP35G+47**YY	14TP35G+47**YY			
					SLEEVE	13TP35G+90**YY	14TP35G+90**YY			
		POLY-PRO™	300	PRECISION	BALL	13PP35G+42**YY	14PP35G+42**YY			
					PRECISION	13PP35G+44**YY	14PP35G+44**YY			
					DELTRIN	13PP35G+47**YY	14PP35G+47**YY			
					SLEEVE	13PP35G+55**YY	14PP35G+55**YY			
		POLYMADIC™	325	ANNULAR	DELTRIN	13PP35G+90**YY	14PP35G+90**YY			
					DELTRIN	13PM35GM5A**YY	14PM35GM5A**YY			
		POLYON AL™	350	ANNULAR	13PM35GM43**YY	14PM35GM43**YY				
		DISC WHEEL	250	BALL	13PA35GL43**YY	14PA35GL43**YY				
		HARD RUBBER	300	PLAIN	13UN35GLA3**YY	14UN35GLA3**YY				
		POLYOLEFIN	300	PLAIN	PLAIN	13HR35GB82**YY	14HR35GB82**YY			
SLEEVE	13P035GZ82**YY				14P035GZ82**YY					
PHENOLIC	350	TOP HEAD	13P035GJ90**YY	14P035GJ90**YY						
SEMI-STEEL	350	PLAIN	13PH35GB99**YY	14PH35GB99**YY						
				PLAIN	13SS35GS82**YY	14SS35GS82**YY				
4	1-1/4	YOKE AND AXLE/NUT				13ZZ40GZ82**YAN	14ZZ40GZ82**YAN	5-3/16" (REPLACE 40 WITH 4 X FOR 5" O. A. H.)	3-7/16	T, Y T, Y  W, K, P   B, Z J, Z  B, E
		SOFT RUBBER	350	PLAIN	13SR40GB82**YY	14SR40GB82**YY				
		RUBBER/ALU	250	ANNULAR	BALL	13SR40GB42**YY	14SR40GB42**YY			
					ANNULAR	13RA40GI43**YY	14RA40GI43**YY			
		NOMADIC™	300	DELTRIN	13NM40GI5A*8YY	14NM40GI5A**YY				
		CONDUCTIVE	250	PRECISION	ANNULAR	13NM40GI43**YY	14NM40GI43**YY			
					PRECISION	13CN40GH44**YY	14CN40GH44**YY			
		THERMO-PRO™	250	PRECISION	PRECISION	13TP40GI44**YY	14TP40GI44**YY			
					SLEEVE	13TP40G+47**YY	14TP40G+47**YY			
		ELEMENT™	240	ANNULAR	SLEEVE	13TP40G+90**YY	14TP40G+90**YY			
					ANNULAR	13EL40GI43**YY	14EL40GI43**YY			
		POLY-PRO™	350	PRECISION	BALL	13PP40G+42**YY	14PP40G+42**YY			
					PRECISION	13PP40G+44**YY	14PP40G+44**YY			
					PRECISION	13PP40G+47**YY	14PP40G+47**YY			
					SLEEVE	13PP40G+90**YY	14PP40G+90**YY			
		POLYMADIC™	350	ANNULAR	DELTRIN	13PP40G+90**YY	14PP40G+90**YY			
					DELTRIN	13PM40GM5A**YY	14PM40GM5A**YY			
		DURALASTOMER™	350	ANNULAR	13PM40GM43**YY	14PM40GM43**YY				
		POLYON AL™	350	SLEEVE	13SU40GL90**YY	14SU40GL90**YY				
		DISC WHEEL	270	BALL	13PA40GL43**YY	14PA40GL43**YY				
		HARD RUBBER	350	PLAIN	PLAIN	13UN40GLA3**YY	14UN40GLA3**YY			
					PLAIN	13HR40GB82**YY	14HR40GB82**YY			
		POLYOLEFIN	350	PLAIN	BALL	13HR40GB42**YY	14HR40GB42**YY			
					PLAIN	13P040G+82**YY	14P040G+82**YY			
					SLEEVE	13P040G+90**YY	14P040G+90**YY			
		H. D. POLYOLEFIN	350	PLAIN	BALL	13P040GZ42**YY	14P040GZ42**YY			
					PLAIN	13HP40G+82**YY	14HP40G+82**YY			
					PRECISION	13NY40GE47**YY	14NY40GE47**YY			
NYLON	350	SLEEVE	PRECISION	13NY40GE90**YY	14NY40GE90**YY					
			SLEEVE	13NY40GE90**YY	14NY40GE90**YY					
PHENOLIC	350	TOP HEAD	TOP HEAD	13PH40GB99**YY	14PH40GB99**YY					
			ROLLER	13PH40HB03**YZ	14PH40HB03**YZ					
H.T. PHENOLIC	250	S.S. TOP HEAD	13HT40GQ97**YY	14HT40GQ97**YY						
BRIMSTONE®	350	S.S. TOP HEAD	13GN40GQ97**YY	14GN40GQ97**YY						
STEROLLIZER® AL	300	SLEEVE	13BF40GC97**YZ	14BF40GC97**YZ						
STEROLLIZER® SS	300	SLEEVE	13SL40GC83**YY	14SL40GC83**YY						
SEMI-STEEL	300	PLAIN	PLAIN	13SS40GS82**YY	14SS40GS82**YY					
			SLEEVE	13SS40GS90**YY	14SS40GS90**YY					



# DURABLE SUPERIOR CASTERS®

13/14 LIGHT – MEDIUM DUTY, PLATE MOUNT SERIES – 350 LB

Wheel Dia.	Tread Width	Wheel Type	Load Capacity	Bearings Type	13 Series Swivel Caster Part #	14 Series Rigid Caster Part #	O. A. H.	Swivel Radius	Color
4	1-1/2	POLYON®	350	ROLLER	13PU40H+03**YZ	14PU40H+03**YZ	5-3/16" (REPLACE 40 WITH 4 X FOR 5" O. A. H.)	3-7/16	
		POLYON AL™	350	ROLLER	13PA40H+03**YZ	14PA40H+03**YZ			
		POLYOLEFIN	350	ROLLER	13PO40HB03**YZ	14PO40HB03**YZ			
		PHENOLIC	350	SLEEVE	13PH40HB90**YY	14PH40HB90**YY			
				ROLLER	13PH40HB03**YZ	14PH40HB03**YZ			
		H. T. PHENOLIC	350	SLEEVE	13HT40HQ90**YY	14HT40HQ90**YY			
				ROLLER	13HT40HQ03**YZ	14HT40HQ03**YZ			
		BRIMSTONE®	350	SLEEVE	13GN40HQ90**YY	14GN40HQ90**YY			
ROLLER	13GN40HQ03**YZ			14GN40HQ03**YZ					
STEROLLIZER® AL	350	SS PRECISION	13BH40HC61**YY	14BH40HC61**YY					
STEROLLIZER® SS	350	SS PRECISION	13SL40HC61**YY	14SL40HC61**YY					
EPOXY	350	SLEEVE	13OV40HQ90**YZ	14OV40HQ90**YZ					
5	1-1/4	YOKE AND AXLE/NUT			13ZZ50GZ82**YAN	14ZZ50GZ82**YAN	6-1/8	4	
		SOFT RUBBER	350	PLAIN	13SR50GB82**YY	14SR50GB82**YY			
				BALL	13SR50GB42**YY	14SR50GB42**YY			
		RUBBER/ALU	325	ANNULAR	13RA50GI43**YY	14RA50GI43**YY			
				DELTRIN	13NM50GI5A**YY	14NM50GI5A**YY			
		NOMADIC™	325	ANNULAR	13NM50GI43**YY	14NM50GI43**YY			
				PRECISION	13CN50GH44**YY	14CN50GH44**YY			
		CONDUCTIVE	275	PRECISION	13TP50GI44**YY	14TP50GI44**YY			
				SLEEVE	13TP50G+47**YY	14TP50G+47**YY			
		THERMO-PRO™	300	SLEEVE	13TP50G+90**YY	14TP50G+90**YY			
				ANNULAR	13EL50GI43**YY	14EL50GI43**YY			
		ELEMENT™	250	BALL	13PP50G+42**YY	14PP50G+42**YY			
				PRECISION	13PP50G+44**YY	14PP50G+44**YY			
		POLY-PRO™	350	PRECISION	13PP50G+47**YY	14PP50G+47**YY			
				DELTRIN	13PP50G+55**YY	14PP50G+55**YY			
				SLEEVE	13PP50G+90**YY	14PP50G+90**YY			
				DELTRIN	13PM50GM5A**YY	14PM50GM5A**YY			
		POLYMAC™	350	ANNULAR	13PM50GM43**YY	14PM50GM43**YY			
				SLEEVE	13SU50GL90**YY	14SU50GL90**YY			
		DURALASTOMER™	350	ANNULAR	13PA50GL43**YY	14PA50GL43**YY			
		POLYON AL™	350	ANNULAR	13UN50GLA3**YY	14UN50GLA3**YY			
		DISC WHEEL	300	BALL	13HR50GB82**YY	14HR50GB82**YY			
				BALL	13HR50GB42**YY	14HR50GB42**YY			
		HARD RUBBER	350	PLAIN	13PO50G+82**YY	14PO50G+82**YY			
				SLEEVE	13PO50G+90**YY	14PO50G+90**YY			
		POLYOLEFIN	350	BALL	13PO50GZ42**YY	14PO50GZ42**YY			
PLAIN	13HP50G+82**YY			14HP50G+82**YY					
H. D. POLYOLEFIN	350	PRECISION	13NY50GE47**YY	14NY50GE47**YY					
		SLEEVE	13NY50GE90**YY	14NY50GE90**YY					
PHENOLIC	350	TOP HEAD	13PH50GB99**YY	14PH50GB99**YY					
H. T. PHENOLIC	300	S. S. TOP HEAD	13HT50GQ97**YY	14HT50GQ97**YY					
BRIMSTONE®	350	S. S. TOP HEAD	13GN50GQ97**YY	14GN50GQ97**YY					
SEMI-STEEL	350	PLAIN	13SS50GS82**YY	14SS50GS82**YY					
		SLEEVE	13SS50GS90**YY	14SS50GS90**YY					
5	1-1/2	POLYON®	350	ROLLER	13PU50H+03**YZ	14PU50H+03**YZ	6-1/8	4	
		POLYON AL™	350	ROLLER	13PA50H+03**YZ	14PA50H+03**YZ			
		POLYOLEFIN	350	ROLLER	13PO50HB03**YZ	14PO50HB03**YZ			
		PHENOLIC	350	SLEEVE	13PH50HB90**YY	14PH50HB90**YY			
				ROLLER	13PH50HB03**YZ	14PH50HB03**YZ			
		H. T. PHENOLIC	350	SLEEVE	13HT50HQ90**YY	14HT50HQ90**YY			
				ROLLER	13HT50HQ03**YZ	14HT50HQ03**YZ			
		BRIMSTONE®	350	SLEEVE	13GN50HQ90**YY	14GN50HQ90**YY			
ROLLER	13GN50HQ03**YZ			14GN50HQ03**YZ					
6	1-1/4	YOKE AND AXLE/NUT			13ZZ60GZ82**YAN	14ZZ60GZ82**YAN	7-3/8	4-9/16	
		POLY-PRO™	350	PRECISION	13PP60G+44**YY	14PP60G+44**YY			
				DELTRIN	13PP60G+47**YY	14PP60G+47**YY			
				SLEEVE	13PP60GI55**YY	14PP60GI55**YY			
		THERMO-PRO™	300	PRECISION	13TP60GI44**YY	14TP60GI44**YY			
				SLEEVE	13TP60GT90**YY	14TP60GT90**YY			
				SLEEVE	13TP60GT90**YY	14TP60GT90**YY			
		CUSHION-RIDE™	200	BALL	13CR60G+42**YY	14CR60G+42**YY			
				BALL	13CR60G+42**YY	14CR60G+42**YY			

21, 75/76/78 – LIGHT MEDIUM DUTY WITH DUST COVER SERIES – 350LB



BRAKE OPTIONS				OTHER OPTIONS	
				Thread Guards	G
				H. T. Grease	K
				Zerk Axle	Z

CASTER OVERALL HEIGHT AND SWIVEL RADIUS				
Wheel Diameter	21 Series Swivel Caster		75 Series Swivel Caster	
	Overall H.*	Swivel R.*	Overall H.*	Swivel R.*
3	4	2-15/16	4	3
3-1/2	4-1/2	3-3/16	4-9/16	3-1/4
4	5	3-7/16	5	3-13/32
5	6	4	6-1/8	4
6			7	4-15/32
6-1/4			7-1/8	4-1/8

\*Add 1/8" when it is a plate caster

- Wide variety of popular stem options
- Double ball raceways, with dust cover over raceway
- Standard zinc-plated finish, nickel (95), chrome (85) and black e-coat (XY) are available
- 3/8" axle and nuts
- **Difference between #21 and #75:**
  - #75 series is generously formed with extra material to enhance its durability and appearance, while #21 satisfies most of applications
  - #75 series with hardened raceway offers better strength with longer life

FASTENING OPTIONS								
Replace ** in part # with desired plate or stem code.								
Plate Code	Overall Size		Bolt Hole Pattern		Mounting Bolt Size	Available in Series		
06	2-3/8 X 3-5/8		1-3/4 X 2-7/8 SLOTTED TO 3		5/16	21, 75		
11	3-1/8 X 4-1/8		1-3/4 X 2-15/16 TO 2-3/8 X 3-3/8		3/8	75		
16	3-1/2 X 3-1/2		2-5/8 X 2-5/8 TO 2-3/4 X 2-3/4		5/16	75		
U1	3-1/2 X 3-1/2		1-3/4 X 2-7/8 AND 2-7/8 X 2-7/8		5/16	75		
17	4 X 4-1/2		2-5/8 X 3-5/8 TO 3 X 3		3/8	75		
Stem Code	Size	Stem Type	Available in Series	Stem Code	Size	Stem Type	Available in Series	
60	3/8 - 16 X 3/4	THREADED	21	70	1/2 - 13 X 2-3/4	THREADED	21, 75	
61	3/8 - 16 X 1		21	71	.720 - .851	ROUNDED EXPANDABLE ADAPTER	21, 75	
62	3/8 - 16 X 1-1/2		21, 75	7S	.920-0.980		21, 75	
66	1/2 - 13 X 3/4		21	72	.852 - .927		21, 75	
67	1/2 - 13 X 1		21, 75	73	.928 - 1.029		21, 75	
68	1/2 - 13 X 1-1/2		21, 75	7A	1.020-1.100		21, 75	
69	1/2 - 13 X 2		21, 75	74	1.030 - 1.14		21, 75	
80	5/8-11 X 1		75	75	1.360 - 1.425		21, 75	
81	5/8-11 X 1-3/4		21, 75	76	1.426 - 1.589		21, 75	
88	3/4 - 10 X 1		75	77	1.790 - 1.850		21, 75	
87	3/4 - 10 X 1-3/4		21, 75	78	1.178-1.303		21, 75	
6S	1/2-13X3/8		21, 75	R1	.720-.851	SQUARE EXPANDABLE ADAPTER	21, 75	
91	7/16 X 1-3/8		GRIP RING	21	R2		.852-.927	21, 75
95	0.846 X 2-3/16		GRIP RING	21	R3		.928-1.029	21, 75
97	7/16 X 2		GRIP RING	21	R4		1.030-1.140	21, 75
51	3/4 X 2		OCTAGON	21, 75	R5		1.360-1.425	21, 75
41	7/8 X 2	OCTAGON W/ GRIP RING	21, 75	R6	1.426-1.589		21, 75	
42	7/8 X 2	OCTAGON W/ GRIP RING, 5/16 CROSS DRILL	21	R7	1.790-1.850		21, 75	
W4	0.865 X 2-1/2	SQUARE W/1/4 CROSS DRILL 1" AND 2-1/8"	75	U2	.852-.927		21, 75	
86	3/4" NPT X 1	PIPE THREAD	75	D2			21, 75	
A4	3/4-10 L=3-5/8	INNER TAPPED	75	T2			21, 75	
				U5		21, 75		
				1.360-1.425		21, 75		



# DURABLE SUPERIOR CASTERS®

21, 75/76/78 – LIGHT MEDIUM DUTY WITH DUST COVER SERIES – 350 LB

Wheel Dia.	Tread Width	Wheel Type	Load Capacity	Bearings Type	21 Series Swivel Caster Part #	75 Series Swivel Caster Part #	76 Series Rigid Caster Part #	78 Series Rigid Caster Part #	Color	
2-1/2	1-1/4	YOKE AND AXLE/NUT				21Z225GZ82**YAN				
		SOFT RUBBER	175	PLAIN	21SR25GB82**YY					
		THERMO-PRO™	250	PRECISION BALL	21TP25GI44**YY 21TP25GB42**YY					
		POLYOLEFIN	250	PLAIN	21PO25GB82**YY					
		POLY-PRO™	250	BALL	21PP25G+42**YY					M, W
		HARD RUBBER	250	PLAIN	21HR25GB82**YY					
3	1-1/4	YOKE AND AXLE/NUT				21Z230GZ82ZZYAN	75Z230GZ82ZZYAN	76Z230GZ82ZZYAN	78Z230GZ82ZZYAN	
		SOFT RUBBER	300	PLAIN	21SR30GB82**YY	75SR30GB82**YY	76SR30GB82**YY	78SR30GB82**YY		
				BALL	21SR30GB42**YY	75SR30GB42**YY	76SR30GB42**YY	78SR30GB42**YY		
		NOMADIC™	300	DELTRIN	21NM30GI5A**YY	75NM30GI5A**YY	76NM30GI5A**YY	78NM30GI5A**YY		
				ANNULAR	21NM30GI43**YY	75NM30GI43**YY	76NM30GI43**YY	78NM30GI43**YY		
		CONDUCTIVE TPR	200	PRECISION	21CN30GH44**YY	75CN30GH44**YY	76CN30GH44**YY	78CN30GH44**YY		
		CONDUCTIVE SR	250	BALL	21CT30GB42**YY	75CT30GB42**YY	76CT30GB42**YY	78CT30GB42**YY		
		THERMO-PRO™	210	PRECISION	21TP30GI44**YY	75TP30GI44**YY	76TP30GI44**YY	78TP30GI44**YY		
				PRECISION	21TP30G+47**YY	75TP30G+47**YY	76TP30G+47**YY	78TP30G+47**YY	T, Y	
				SLEEVE	21TP30G+90**YY	75TP30G+90**YY	76TP30G+90**YY	78TP30G+90**YY		
		ELEMENT™	210	ANNULAR	21EL30GI43**YY	75EL30GI43**YY	76EL30GI43**YY	78EL30GI43**YY		
				BALL	21PP30G+42**YY	75PP30G+42**YY	76PP30G+42**YY	78PP30G+42**YY	K, W	
		POLY-PRO™	300	PRECISION	21PP30G+44**YY	75PP30G+44**YY	76PP30G+44**YY	78PP30G+44**YY	A, D, I, K, S	
					21PP30G+47**YY	75PP30G+47**YY	76PP30G+47**YY	78PP30G+47**YY	T, Y	
				DELTRIN	21PP30G+55**YY	75PP30G+55**YY	76PP30G+55**YY	78PP30G+55**YY	K, W, P	
				SLEEVE	21PP30G+90**YY	75PP30G+90**YY	76PP30G+90**YY	78PP30G+90**YY	T, Y	
		POLYMADIC™	300	DELTRIN	21PM30GM5A**YY	75PM30GM5A**YY	76PM30GM5A**YY	78PM30GM5A**YY		
				ANNULAR	21PM30GM43**YY	75PM30GM43**YY	76PM30GM43**YY	78PM30GM43**YY		
		DURALASTOMER™	300	SLEEVE	21SU30GL90**YY	75SU30GL90**YY	76SU30GL90**YY	78SU30GL90**YY		
		POLYON AL™	350	ANNULAR	21PA30GL43**YY	75PA30GL43**YY	76PA30GL43**YY	78PA30GL43**YY		
		HARD RUBBER	300	BALL	21HR30GB42**YY	75HR30GB42**YY	76HR30GB42**YY	78HR30GB42**YY		
				PLAIN	21HR30GB82**YY	75HR30GB82**YY	76HR30GB82**YY	78HR30GB82**YY		
		GRAYROK™	300	PLAIN	21RK30GI82**YY	75RK30GI82**YY	76RK30GI82**YY	78RK30GI82**YY		
		POLYOLEFIN	250	PLAIN	21P030G+82**YY	75P030G+82**YY	76P030G+82**YY	78P030G+82**YY	B, Z	
				SLEEVE	21P030G+90**YY	75P030G+90**YY	76P030G+90**YY	78P030G+90**YY	J, Z	
				BALL	21P030GZ42**YY	75P030GZ42**YY	76P030GZ42**YY	78P030GZ42**YY		
		H. D. POLYOLEFIN	300	PLAIN	21HP30G+82**YY	75HP30G+82**YY	76HP30G+82**YY	78HP30G+82**YY	B, E	
		NYLON	300	SLEEVE	21NY30GE90**YY	75NY30GE90**YY	76NY30GE90**YY	78NY30GE90**YY		
				PRECISION	21NY30GE47**YY	75NY30GE47**YY	76NY30GE47**YY	78NY30GE47**YY		
		PHENOLIC	300	TOP HEAD	21PH30GB99**YY	75PH30GB99**YY	76PH30GB99**YY	78PH30GB99**YY		
		H. T. PHENOLIC	200	S.S.TOP HEAD	21HT30GQ97**YY	75HT30GQ97**YY	76HT30GQ97**YY	78HT30GQ97**YY		
		BRIMSTONE®	350	S.S.TOP HEAD	21GN30GQ97**YY	75GN30GQ97**YY	76GN30GQ97**YY	78GN30GQ97**YY		
SEMI-STEEL	350	PLAIN	21SS30GS82**YY	75SS30GS82**YY	76SS30GS82**YY	78SS30GS82**YY				
		SLEEVE	21SS30GS90**YY	75SS30GS90**YY	76SS30GS90**YY	78SS30GS90**YY				
SINTERED IRON	350	PLAIN	21SI30GS82**YY	75SI30GS82**YY	76SI30GS82**YY	78SI30GS82**YY				
V-GROOVE	350	PLAIN	21VG30GT82**YY	75VG30GT82**YY	76VG30GT82**YY	78VG30GT82**YY				
1-1/2	PHENOLIC	SLEEVE	21PH30GB90**YY	75PH30GB90**YY	76PH30GB90**YY	78PH30GB90**YY				
		ROLLER	21PH30HB03**YZ	75PH30HB03**YZ	76PH30HB03**YZ	78PH30HB03**YZ				
3-1/2	1-1/4	YOKE AND AXLE/NUT				21Z235GZ82ZZYAN	75Z235GZ82ZZYAN	76Z235GZ82ZZYAN	78Z235GZ82ZZYAN	
		SOFT RUBBER	350	PLAIN	21SR35GB82**YY	75SR35GB82**YY	76SR35GB82**YY	78SR35GB82**YY		
		RUBBER/ALU	250	ANNULAR	21RA35GI43**YY	75RA35GI43**YY	76RA35GI43**YY	78RA35GI43**YY		
		NOMADIC™	300	DELTRIN	21NM35GI5A**YY	75NM35GI5A**YY	76NM35GI5A**YY	78NM35GI5A**YY		
				ANNULAR	21NM35GI43**YY	75NM35GI43**YY	76NM35GI43**YY	78NM35GI43**YY		
		THERMO-PRO™	230	PRECISION	21TP35GI44**YY	75TP35GI44**YY	76TP35GI44**YY	78TP35GI44**YY		
				PRECISION	21TP35G+47**YY	75TP35G+47**YY	76TP35G+47**YY	78TP35G+47**YY	T, Y	
				SLEEVE	21TP35G+90**YY	75TP35G+90**YY	76TP35G+90**YY	78TP35G+90**YY		
		ELEMENT	220	ANNULAR	21EL35GI43**YY	75EL35GI43**YY	76EL35GI43**YY	78EL35GI43**YY		
		POLY-PRO™	300	PRECISION	21PP35G+42**YY	75PP35G+42**YY	76PP35G+42**YY	78PP35G+42**YY	K, W, P	
					21PP35G+44**YY	75PP35G+44**YY	76PP35G+44**YY	78PP35G+44**YY	A, D, I, K, S	
				DELTRIN	21PP35G+47**YY	75PP35G+47**YY	76PP35G+47**YY	78PP35G+47**YY	T, Y	
				SLEEVE	21PP35G+90**YY	75PP35G+90**YY	76PP35G+90**YY	78PP35G+90**YY	T, Y	
		POLYMADIC™	325	DELTRIN	21PM35GM5A**YY	75PM35GM5A**YY	76PM35GM5A**YY	78PM35GM5A**YY		
				ANNULAR	21PM35GM43**YY	75PM35GM43**YY	76PM35GM43**YY	78PM35GM43**YY		
		POLYON AL™	350	ANNULAR	21PA35GL43**YY	75PA35GL43**YY	76PA35GL43**YY	78PA35GL43**YY		
		DISC WHEEL	250	BALL	21UN35GLA3**YY	75UN35GLA3**YY	76UN35GLA3**YY	78UN35GLA3**YY		
		HARD RUBBER	300	PLAIN	21HR35GB82**YY	75HR35GB82**YY	76HR35GB82**YY	78HR35GB82**YY		
				PLAIN	21P035GZ82**YY	75P035GZ82**YY	76P035GZ82**YY	78P035GZ82**YY		
		POLYOLEFIN	300	SLEEVE	21P035GJ90**YY	75P035GJ90**YY	76P035GJ90**YY	78P035GJ90**YY		
SLEEVE	21PH35GB99**YY			75PH35GB99**YY	76PH35GB99**YY	78PH35GB99**YY				
PHENOLIC	350	TOP HEAD	21PH35GB99**YY	75PH35GB99**YY	76PH35GB99**YY	78PH35GB99**YY				
4	1-1/4	YOKE AND AXLE/NUT				21Z240GZ82ZZYAN	75Z240GZ82ZZYAN	76Z240GZ82ZZYAN	78Z240GZ82ZZYAN	
		SOFT RUBBER	350	PLAIN	21SR40GB82**YY	75SR40GB82**YY	76SR40GB82**YY	78SR40GB82**YY		
				BALL	21SR40GB42**YY	75SR40GB42**YY	76SR40GB42**YY	78SR40GB42**YY		
		RUBBER/ALU	300	ANNULAR	21RA40GI43**YY	75RA40GI43**YY	76RA40GI43**YY	78RA40GI43**YY		
		NOMADIC™	300	DELTRIN	21NM40GI5A**YY	75NM40GI5A**YY	76NM40GI5A**YY	78NM40GI5A**YY		
				ANNULAR	21NM40GI43**YY	75NM40GI43**YY	76NM40GI43**YY	78NM40GI43**YY		

21, 75/76/78 – LIGHT MEDIUM DUTY WITH DUST COVER SERIES – 350LB

Wheel Dia.	Tread Width	Wheel Type	Load Capacity	Bearings Type	21 Series Swivel Caster Part #	75 Series Swivel Caster Part #	76 Series Rigid Caster Part #	78 Series Rigid Caster Part #	Color	
4	1-1/4	CONDUCTIVE	250	PRECISION	21CN40GH44**YY	75CN40GH44**YY	76CN40GH44**YY	78CN40GH44**YY		
		THERMO-PRO™	250	PRECISION	21TP40G144**YY	75TP40G144**YY	76TP40G144**YY	78TP40G144**YY		
				PRECISION	21TP40G+47**YY	75TP40G+47**YY	76TP40G+47**YY	78TP40G+47**YY	T, Y	
				SLEEVE	21TP40G+90**YY	75TP40G+90**YY	76TP40G+90**YY	78TP40G+90**YY	T, Y	
		ELEMENT™	240	ANNULAR	21EL40GI43**YY	75EL40GI43**YY	76EL40GI43**YY	78EL40GI43**YY		
		POLY-PRO™	350	BALL	21PP40G+42**YY	75PP40G+42**YY	76PP40G+42**YY	78PP40G+42**YY	W, K, P	
				PRECISION	21PP40G+44**YY	75PP40G+44**YY	76PP40G+44**YY	78PP40G+44**YY	T, Y	
				DELTRIN	21PP40G+55**YY	75PP40G+55**YY	76PP40G+55**YY	78PP40G+55**YY	W, K	
				SLEEVE	21PP40G+90**YY	75PP40G+90**YY	76PP40G+90**YY	78PP40G+90**YY	T, Y	
		POLYMADIC™	350	DELTRIN	21PM40GM5A**YY	75PM40GM5A**YY	76PM40GM5A**YY	78PM40GM5A**YY		
		ANNULAR		21PM40GM43**YY	75PM40GM43**YY	76PM40GM43**YY	78PM40GM43**YY			
		DURALASTOMER™	350	SLEEVE	21SU40GL90**YY	75SU40GL90**YY	76SU40GL90**YY	78SU40GL90**YY		
		POLYON AL™	350	ANNULAR	21PA40GL43**YY	75PA40GL43**YY	76PA40GL43**YY	78PA40GL43**YY		
		DISC WHEEL	270	BALL	21UN40GLA3**YY	75UN40GLA3**YY	76UN40GLA3**YY	78UN40GLA3**YY		
		HARD RUBBER	350	PLAIN	21HR40GB82**YY	75HR40GB82**YY	76HR40GB82**YY	78HR40GB82**YY		
				BALL	21HR40GB42**YY	75HR40GB42**YY	76HR40GB42**YY	78HR40GB42**YY		
				PLAIN	21P040G+82**YY	75P040G+82**YY	76P040G+82**YY	78P040G+82**YY	B, Z	
		POLYOLEFIN	350	SLEEVE	21P040G+90**YY	75P040G+90**YY	76P040G+90**YY	78P040G+90**YY	J, Z	
				BALL	21P040GZ42**YY	75P040GZ42**YY	76P040GZ42**YY	78P040GZ42**YY		
				PLAIN	21HP40G+82**YY	75HP40G+82**YY	76HP40G+82**YY	78HP40G+82**YY	B, E	
		H. D. POLYOLEFIN	350	PLAIN	21HP40G+82**YY	75HP40G+82**YY	76HP40G+82**YY	78HP40G+82**YY		
	NYLON	350	PRECISION	21NY40GE47**YY	75NY40GE47**YY	76NY40GE47**YY	78NY40GE47**YY			
			SLEEVE	21NY40GN90**YY	75NY40GN90**YY	76NY40GN90**YY	78NY40GN90**YY			
	PHENOLIC	350	TOP HEAD	21PH40GB99**YY	75PH40GB99**YY	76PH40GB99**YY	78PH40GB99**YY			
			ROLLER	21PH40HB03**YZ	75PH40HB03**YZ	76PH40HB03**YZ	78PH40HB03**YZ			
	H. T. PHENOLIC	250	S. S. TOP HEAD	21HT40GQ97**YY	75HT40GQ97**YY	76HT40GQ97**YY	78HT40GQ97**YY			
	BRIMSTONE®	350	S. S. TOP HEAD	21GN40GQ97**YY	75GN40GQ97**YY	76GN40GQ97**YY	78GN40GQ97**YY			
	STEROLLIZER® AL	300	SLEEVE	21BF40GC97**YZ	75BF40GC97**YZ	76BF40GC97**YZ	78BF40GC97**YZ			
			SLEEVE	21SL40GC83**YY	75SL40GC83**YY	76SL40GC83**YY	78SL40GC83**YY			
	STEROLLIZER® SS	300	PLAIN	21SS40GS82**YY	75SS40GS82**YY	76SS40GS82**YY	78SS40GS82**YY			
			SLEEVE	21SS40GS90**YY	75SS40GS90**YY	76SS40GS90**YY	78SS40GS90**YY			
	SEMI-STEEL	300	ROLLER	21PU40H+03**YZ	75PU40H+03**YZ	76PU40H+03**YZ	78PU40H+03**YZ			
	POLYON®	350	ROLLER	21PA40H+03**YZ	75PA40H+03**YZ	76PA40H+03**YZ	78PA40H+03**YZ			
	POLYON AL™	350	ROLLER	21PA40H+03**YZ	75PA40H+03**YZ	76PA40H+03**YZ	78PA40H+03**YZ			
	POLYOLEFIN	350	ROLLER	21PO40HB03**YZ	75PO40HB03**YZ	76PO40HB03**YZ	78PO40HB03**YZ			
	PHENOLIC	350	SLEEVE	21PH40HB90**YY	75PH40HB90**YY	76PH40HB90**YY	78PH40HB90**YY			
			ROLLER	21PH40HB03**YZ	75PH40HB03**YZ	76PH40HB03**YZ	78PH40HB03**YZ			
	H. T. PHENOLIC	350	SLEEVE	21HT40HQ90**YY	75HT40HQ90**YY	76HT40HQ90**YY	78HT40HQ90**YY			
			ROLLER	21HT40HQ03**YZ	75HT40HQ03**YZ	76HT40HQ03**YZ	78HT40HQ03**YZ			
	BRIMSTONE®	350	SLEEVE	21GN40HQ90**YY	75GN40HQ90**YY	76GN40HQ90**YY	78GN40HQ90**YY			
			ROLLER	21GN40HQ03**YZ	75GN40HQ03**YZ	76GN40HQ03**YZ	78GN40HQ03**YZ			
	STEROLLIZER® AL	350	SS PRECISION	21BH40HC61**YY	75BH40HC61**YY	76BH40HC61**YY	78BH40HC61**YY			
STEROLLIZER® SS	350	SS PRECISION	21SL40HC61**YY	75SL40HC61**YY	76SL40HC61**YY	78SL40HC61**YY				
EPOXY	350	SLEEVE	21OV40HQ90**YZ	75OV40HQ90**YZ	76OV40HQ90**YZ	78OV40HQ90**YZ				
5	1-1/4	YOKE AND AXLE/NUT				21ZZ50GZ82ZZYAN	75ZZ50GZ82ZZYAN	76ZZ50GZ82ZZYAN	78ZZ50GZ82ZZYAN	
		SOFT RUBBER	350	PLAIN	21SR50GB82**YY	75SR50GB82**YY	76SR50GB82**YY	78SR50GB82**YY		
				BALL	21SR50GB42**YY	75SR50GB42**YY	76SR50GB42**YY	78SR50GB42**YY		
		RUBBER/ALU	325	ANNULAR	21RA50GI43**YY	75RA50GI43**YY	76RA50GI43**YY	78RA50GI43**YY		
		NOMADIC™	325	DELTRIN	21NM50GI5A**YY	75NM50GI5A**YY	76NM50GI5A**YY	78NM50GI5A**YY		
				ANNULAR	21NM50GI43**YY	75NM50GI43**YY	76NM50GI43**YY	78NM50GI43**YY		
		CONDUCTIVE	275	PRECISION	21CN50GH44**YY	75CN50GH44**YY	76CN50GH44**YY	78CN50GH44**YY		
		THERMO-PRO™	300	PRECISION	21TP50G144**YY	75TP50G144**YY	76TP50G144**YY	78TP50G144**YY		
				PRECISION	21TP50G+47**YY	75TP50G+47**YY	76TP50G+47**YY	78TP50G+47**YY	T, Y	
				SLEEVE	21TP50G+90**YY	75TP50G+90**YY	76TP50G+90**YY	78TP50G+90**YY		
		ELEMENT™	250	ANNULAR	21EL50GI43**YY	75EL50GI43**YY	76EL50GI43**YY	78EL50GI43**YY		
				BALL	21PP50G+42**YY	75PP50G+42**YY	76PP50G+42**YY	78PP50G+42**YY	C, K, P, W	
		POLY-PRO™	350	PRECISION	21PP50G+44**YY	75PP50G+44**YY	76PP50G+44**YY	78PP50G+44**YY	I, A, D, S	
				PRECISION	21PP50G+47**YY	75PP50G+47**YY	76PP50G+47**YY	78PP50G+47**YY	T, Y	
				DELTRIN	21PP50G+55**YY	75PP50G+55**YY	76PP50G+55**YY	78PP50G+55**YY	C, K, P, W	
				SLEEVE	21PP50G+90**YY	75PP50G+90**YY	76PP50G+90**YY	78PP50G+90**YY	T, Y	
		POLYMADIC™	350	DELTRIN	21PM50GM5A**YY	75PM50GM5A**YY	76PM50GM5A**YY	78PM50GM5A**YY		
		ANNULAR		21PM50GM43**YY	75PM50GM43**YY	76PM50GM43**YY	78PM50GM43**YY			
		DURALASTOMER™	350	SLEEVE	21SU50GL90**YY	75SU50GL90**YY	76SU50GL90**YY	78SU50GL90**YY		
		POLYON AL™	350	ANNULAR	21PA50GL43**YY	75PA50GL43**YY	76PA50GL43**YY	78PA50GL43**YY		
		DISC WHEEL	300	BALL	21UN50GLA3**YY	75UN50GLA3**YY	76UN50GLA3**YY	78UN50GLA3**YY		
	HARD RUBBER	350	PLAIN	21HR50GB82**YY	75HR50GB82**YY	76HR50GB82**YY	78HR50GB82**YY			
			BALL	21HR50GB42**YY	75HR50GB42**YY	76HR50GB42**YY	78HR50GB42**YY			
	POLYOLEFIN	350	PLAIN	21P050G+82**YY	75P050G+82**YY	76P050G+82**YY	78P050G+82**YY	B, Z		
			SLEEVE	21P050G+90**YY	75P050G+90**YY	76P050G+90**YY	78P050G+90**YY	J, Z		
			BALL	21P050GZ42**YY	75P050GZ42**YY	76P050GZ42**YY	78P050GZ42**YY			
	H. D. POLYOLEFIN	350	PLAIN	21HP50G+82**YY	75HP50G+82**YY	76HP50G+82**YY	78HP50G+82**YY	B, E		
	NYLON	350	PRECISION	21NY50GE47**YY	75NY50GE47**YY	76NY50GE47**YY	78NY50GE47**YY			
			SLEEVE	21NY50GE90**YY	75NY50GE90**YY	76NY50GE90**YY	78NY50GE90**YY			
	PHENOLIC	350	TOP HEAD	21PH50GB99**YY	75PH50GB99**YY	76PH50GB99**YY	78PH50GB99**YY			



# DURABLE SUPERIOR CASTERS®

21, 75/76/78 – LIGHT MEDIUM DUTY WITH DUST COVER SERIES – 350 LB

Wheel Dia.	Tread Width	Wheel Type	Load Capacity	Bearings Type	21 Series Swivel Caster Part #	75 Series Swivel Caster Part #	76 Series Rigid Caster Part #	78 Series Rigid Caster Part #	Color
		H. T. PHENOLIC	300	S. S TOP HEAD	21HT50GQ97**YY	75HT50GQ97**YY	76HT50GQ97**YY	78HT50GQ97**YY	
		BRIMSTONE®	350	S. S TOP HEAD	21GN50GQ97**YY	75GN50GQ97**YY	76GN50GQ97**YY	78GN50GQ97**YY	
		SEMI-STEEL	350	PLAIN	21SS50GS82**YY	75SS50GS82**YY	76SS50GS82**YY	78SS50GS82**YY	
				SLEEVE	21SS50GS90**YY	75SS50GS90**YY	76SS50GS90**YY	78SS50GS90**YY	
5	1/1/2	POLYON®	350	ROLLER	21PU50H+03**YZ	75PU50H+03**YZ	76PU50H+03**YZ	78PU50H+03**YZ	
		POLYON AL™	350	ROLLER	21PA50H+03**YZ	75PA50H+03**YZ	76PA50H+03**YZ	78PA50H+03**YZ	
		POLYOLEFIN	350	ROLLER	21PO50HB03**YZ	75PO50HB03**YZ	76PO50HB03**YZ	78PO50HB03**YZ	
		PHENOLIC	350	SLEEVE	21PH50HB90**YY	75PH50HB90**YY	76PH50HB90**YY	78PH50HB90**YY	
				ROLLER	21PH50HB03**YZ	75PH50HB03**YZ	76PH50HB03**YZ	78PH50HB03**YZ	
		H. T. PHENOLIC	350	SLEEVE	21HT50HQ90**YY	75HT50HQ90**YY	76HT50HQ90**YY	78HT50HQ90**YY	
				ROLLER	21HT50HQ03**YZ	75HT50HQ03**YZ	76HT50HQ03**YZ	78HT50HQ03**YZ	
		BRIMSTONE®	350	SLEEVE	21GN50HQ90**YY	75GN50HQ90**YY	76GN50HQ90**YY	78GN50HQ90**YY	
ROLLER	21GN50HQ03**YZ			75GN50HQ03**YZ	76GN50HQ03**YZ	78GN50HQ03**YZ			
6	1-1/4	YOKE AND AXLE/NUT				75ZZ60GZ82**YY	76ZZ60GZ82**YY	78ZZ60GZ82**YY	
		POLY-PRO™	350	PRECISION		75PP60G+44**YY	76PP60G+44**YY	78PP60G+44**YY	A, I
				DELFIN		75PP60G+47**YY	76PP60G+47**YY	78PP60G+47**YY	T, Y
				SLEEVE		75PP60GI55**YY	76PP60GI55**YY	78PP60GI55**YY	
		THERMO-PRO™	300	PRECISION		75TP60GI44**YY	76TP60GI44**YY	78TP60GI44**YY	
				SLEEVE		75TP60GT47**YY	76TP60GT47**YY	78TP60GT47**YY	
DISC WHEEL	300	BALL		75UN60GLA3**YY	76UN60GLA3**YY	78UN60GLA3**YY			
6-1/4	1-1/4	CUSHION-RIDE™	200	BALL		75CR60G+42**YY	76CR60G+42**YY	78CR60G+42**YY	A, I

Our highly trained and experienced customer service and sales staff can help assist you in choosing the appropriate caster or wheel for your application.



T1, T3, 17, FS, TH, F7 – TOTAL LOCK AND DIRECTIONAL LOCK – 350LB



Multiple Modular Stem Options

- Simultaneously lock both the swivel raceway and the wheel
- Variety of designs for different preferences
- Double ball raceways
- 3/8" axle/nut
- **#17** series is equipped with a die-cast zinc pedal, designed for high use durability and high temperature applications
- **#T3** series is equipped with glass filled nylon pedal for cost efficiency
- **#FS** series is designed to shorten swivel radius slightly for tight fit environment
- **#TH** series is designed for the convenience of field installable, and attractive appearance
- **#F7** series has its locking mechanism at the leading side of the caster. This design eliminates the extended swivel radius from other designs. Due to its design, the flexibility of modular device is not available. Consult factory for your special needs on fastenings
- **#17, #T3, #FS, #TH** are also available in modular device. Please check our modular casters for other available fastening patterns
- Each total lock caster has its own matching swivel and rigid caster
- **#T1** series is the Directional Locking caster. It shares the design of #17 series casters

FASTENING OPTION					
Replace ** in part # with desired plate or stem code.					
Plate Code	Overall Size	Bolt Hole Pattern		Mounting Bolt Dia.	
06	2-3/8 X 3-5/8	1-3/4 X 2-7/8 SLOTTED TO 3		5/16	
S6	2-3/8 X 3-5/8	2-3/4 X 2-3/16 TO 3 X 1-3/4		5/16	
11	3-1/8 X 4-1/8	1-3/4 X 2-15/16 TO 2-3/8 X 3-3/8		3/8	
16	3-1/2 X 3-1/2	2-5/8 X 2-5/8 TO 2-3/4 X 2-3/4		5/16	
10	85MM X 95MM	60MM X 80MM		5/16	
99	5.5 X 5.5 TRIANGLE	REFER TO DRAWING		5/16	
MS	3 X 3-3/4	1-5/8 X 3 TO 2-5/8 X 3-1/8		5/16	
Stem Code	Size	Stem Type	Stem Code	Size	Stem Type
63	3/8 - 16 X 1/2	THREADED	86	3/4" NPT X 1	PIPE THREAD
62	3/8 - 16 X 1-1/2		67	1/2 - 13 X 1	THREADED
95	.846 X 2-3/16	GRIP RING	68	1/2 - 13 X 1-1/2	
91	7/16 X 1-3/8		70	1-1/2 - 13 X 2-3/4	
84	0.865 X 2-1/2		81	5/8 - 11 X 1-3/4	
71	.720 - .851	ROUNDED ADAPTER	88	3/4 - 10 X 1	
72	.852 - .927		87	3/4 - 10 X 1-3/4	
7B	0.920-0.980		R1	.720 - .851	
73	.928 - 1.029		R2	.852 - .927	
7A	1.020-1.100		R3	.928 - 1.029	
74	1.030 - 1.140		R4	1.030 - 1.140	
75	1.360 - 1.425		R5	1.360 - 1.425	
76	1.426 - 1.589		R6	1.426 - 1.589	
77	1.790 - 1.850		R7	1.790 - 1.850	
78	1.178 - 1.303		ZZ	HOLLOW KINGPIN	SEE MODULAR STEM CASTER

Wheel Dia.	T3 Series Swivel Caster		17 Series Swivel Caster		FS Series Swivel Caster		TH Series Swivel Caster		F7 Series Swivel Caster	
	Overall H.*	Swivel R.	Overall H.*	Swivel R.	Overall H.*	Swivel R.	Overall H.*	Swivel R.	Overall H.*	Swivel R.
3"	4-1/8	4-7/8	4-1/4	4-7/8	4-3/16	4-5/8	4-1/16	4-1/2	4-1/16	2-7/8
3-1/2"	4-5/8		4-3/4		4-13/16		4-13/16		3-5/16	
4"	5-1/8		5-1/4		5-5/16		5-1/16		3-9/16	
5"	6-1/4		6-1/4		6-3/8		6-1/8		4-5/16	
6"	7-1/8									

Matching Swivel and Rigid — replace the prefix to order matching swivel or rigid.

Swivel	Rigid	Dir. Lock	Swivel	Rigid	Dir. Lock	Swivel	Rigid	Dir. Lock	Swivel	Rigid	Dir. Lock	Swivel	Rigid
75	76, 78	TD	18	19	T1	FM	FR	FD	SH	RH	DH	SH	RH

Available Fastening in Each Series

06, 11, 16, 10, 99, 62, 63, 67, 68, 70, 71, 72, 7S, 73, 7A, 74, 75, 76, 77, R1, R2, R3, R4, R5, R6, R7, 86, ZZ (Directional-lock applies only to plate casters)	06, S6, 11, 10, MS, 62, 63, 67, 68, 70, 71, 72, 7S, 73, 7A, 74, 75, 76, 77, R1, R2, R3, R4, R5, R6, R7, ZZ (Directional-lock applies only to plate casters)	MS, 68, ZZ (Directional-lock applies only to plate casters)	06, 67, 68, 70, 71, 72, 7S, 73, 7A, 74, 75, 76, 77, R1, R2, R3, R4, R5, R6, R7, ZZ (Directional-lock applies only to plate casters)
---	---	---	---

\*Reduce overall height 1/8 for stem casters.



# DURABLE SUPERIOR CASTERS®

T1, T3, 17, FS, TH, F7 – TOTAL LOCK AND DIRECTIONAL LOCK – 350 LB

Wh. Dia.	Tread Width	Wheel Type	Load Cap.	Bearings Type	T3 Series Swivel Caster Part #	17 Series Swivel Caster Part #	FS Series Swivel Caster Part #	TH Series Swivel Caster Part #	F7 Series Swivel Caster Part #	T1 Series Swivel Caster Part #	Color			
3	1-1/4	YOKE AND AXLE/NUT				T3ZZ30GZ82**YAN	17ZZ30GZ82**YAN	FSZZ30GZ82**YAN	THZZ30GZ82**YAN	F7ZZ30GZ82**YAN	T1ZZ30GZ82**YAN			
		SOFT RUBBER	300	PLAIN	T3SR30GB82**YY	17SR30GB82**YY	FSSR30GB82**YY	THSR30GB82**YY	F7SR30GB82**YY	T1SR30GB82**YY				
				BALL	T3SR30GB42**YY	17SR30GB42**YY	FSSR30GB42**YY	THSR30GB42**YY	F7SR30GB42**YY	T1SR30GB42**YY				
		NOMADIC™	300	DELRIN	T3NM30GI5A**YY	17NM30GI5A**YY	FSNM30GI5A**YY	THNM30GI5A**YY	F7NM30GI5A**YY	T1NM30GI5A**YY				
				ANNULAR	T3NM30GI43**YY	17NM30GI43**YY	FSNM30GI43**YY	THNM30GI43**YY	F7NM30GI43**YY	T1NM30GI43**YY				
		CONDUCTIVE TPR	200	PRECISION	T3CN30GH44**YY	17CN30GH44**YY	FSCN30GH44**YY	THCN30GH44**YY	F7CN30GH44**YY	T1CN30GH44**YY				
		CONDUCTIVE SR	250	BALL	T3CT30GB42**YY	17C170GB42**YY	FSCF30GB42**YY	THCTH0GB42**YY	F7CF70GB42**YY	T1CT10GB42**YY				
		THERMO-PRO™	210	PRECISION	T3TP30GI44**YY	17TP30GI44**YY	FSTP30GI44**YY	THTP30GI44**YY	F7TP30GI44**YY	T1TP30GI44**YY				
				PRECISION	T3TP30G+47**YY	17TP30G+47**YY	FSTP30G+47**YY	THTP30G+47**YY	F7TP30G+47**YY	T1TP30G+47**YY	T,Y			
				SLEEVE	T3TP30G+90**YY	17TP30G+90**YY	FSTP30G+90**YY	THTP30G+90**YY	F7TP30G+90**YY	T1TP30G+90**YY				
		ELEMENT	210	ANNULAR	T3EL30GI43**YY	17EL30GI43**YY	FSEL30GI43**YY	THEL30GI43**YY	F7EL30GI43**YY	T1EL30GI43**YY				
				BALL	T3PP30G+42**YY	17PP30G+42**YY	FSP30G+42**YY	THPP30G+42**YY	F7PP30G+42**YY	T1PP30G+42**YY	K,W			
		POLY-PRO™	300	PRECISION	T3PP30G+44**YY	17PP30G+44**YY	FSP30G+44**YY	THPP30G+44**YY	F7PP30G+44**YY	T1PP30G+44**YY	A,D,I,K,S			
					T3PP30G+47**YY	17PP30G+47**YY	FSP30G+47**YY	THPP30G+47**YY	F7PP30G+47**YY	T1PP30G+47**YY	T,Y			
				DELRIN	T3PP30G+55**YY	17PP30G+55**YY	FSP30G+55**YY	THPP30G+55**YY	F7PP30G+55**YY	T1PP30G+55**YY	K,W,P			
				SLEEVE	T3PP30G+90**YY	17PP30G+90**YY	FSP30G+90**YY	THPP30G+90**YY	F7PP30G+90**YY	T1PP30G+90**YY	T,Y			
				ANNULAR	T3PM30GM43**YY	17PM30GM43**YY	FSPM30GM43**YY	THPM30GM43**YY	F7PM30GM43**YY	T1PM30GM43**YY				
		DURA-LASTOMER™	300	SLEEVE	T3SU30GL90**YY	17SU30GL90**YY	FSSU30GL90**YY	THSU30GL90**YY	F7SU30GL90**YY	T1SU30GL90**YY				
		POLYON AL™	350	ANNULAR	T3PA30GL43**YY	17PA30GL43**YY	FSPA30GL43**YY	THPA30GL43**YY	F7PA30GL43**YY	T1PA30GL43**YY				
		HARD RUBBER	300	BALL	T3HR30GB42**YY	17HR30GB42**YY	FSHR30GB42**YY	THHR30GB42**YY	F7HR30GB42**YY	T1HR30GB42**YY				
				PLAIN	T3HR30GB82**YY	17HR30GB82**YY	FSHR30GB82**YY	THHR30GB82**YY	F7HR30GB82**YY	T1HR30GB82**YY				
		GRAYROK™	300	PLAIN	T3RK30GI82**YY	17RK30GI82**YY	FSRK30GI82**YY	THRK30GI82**YY	F7RK30GI82**YY	T1RK30GI82**YY				
		POLYOLEFIN	250	PLAIN	T3PO30G+82**YY	17PO30G+82**YY	FSP30G+82**YY	THPO30G+82**YY	F7PO30G+82**YY	T1PO30G+82**YY	B,Z			
				SLEEVE	T3PO30G+90**YY	17PO30G+90**YY	FSP30G+90**YY	THPO30G+90**YY	F7PO30G+90**YY	T1PO30G+90**YY	J,Z			
BALL	T3PO30GZ42**YY			17PO30GZ42**YY	FSP30GZ42**YY	THPO30GZ42**YY	F7PO30GZ42**YY	T1PO30GZ42**YY						
H.D. POLYOLEFIN	300	PLAIN	T3HP30G+82**YY	17HP30G+82**YY	FSP30G+82**YY	THHP30G+82**YY	F7HP30G+82**YY	T1HP30G+82**YY	B,E					
NYLON	300	SLEEVE	T3NY30GE90**YY	17NY30GE90**YY	FSNY30GE90**YY	THNY30GE90**YY	F7NY30GE90**YY	T1NY30GE90**YY						
		PRECISION	T3NY30GE47**YY	17NY30GE47**YY	FSNY30GE47**YY	THNY30GE47**YY	F7NY30GE47**YY	T1NY30GE47**YY						
3-1/2	1-1/4	YOKE AND AXLE/NUT				T3ZZ35GZ82**YAN	17ZZ35GZ82**YAN	FSZZ35GZ82**YAN	THZZ35GZ82**YAN	F7ZZ35GZ82**YAN	T1ZZ35GZ82**YAN			
		SOFT RUBBER	350	PLAIN	T3SR35GB82**YY	17SR35GB82**YY	FSSR35GB82**YY	THSR35GB82**YY	F7SR35GB82**YY	T1SR35GB82**YY				
			RUBBER/ALU	300	ANNULAR	T3RA35GI43**YY	17RA35GI43**YY	FARA35GI43**YY	THRA35GI43**YY	F7RA35GI43**YY	T1RA35GI43**YY			
		NOMADIC™	300	DELRIN	T3NM35GI43**YY	17NM35GI43**YY	FNM35GI43**YY	THNM35GI43**YY	F7NM35GI43**YY	T1NM35GI43**YY				
				ANNULAR	T3NM35GI5A**YY	17NM35GI5A**YY	FNM35GI5A**YY	THNM35GI5A**YY	F7NM35GI5A**YY	T1NM35GI5A**YY				
		ELEMENT™	220	ANNULAR	T3EL35GI43**YY	17EL35GI43**YY	FSEL35GI43**YY	THEL35GI43**YY	F7EL35GI43**YY	T1EL35GI43**YY				
		THERMO-PRO™	230	PRECISION	T3TP35GI44**YY	17TP35GI44**YY	FSTP35GI44**YY	THTP35GI44**YY	F7TP35GI44**YY	T1TP35GI44**YY				
				PRECISION	T3TP35G+47**YY	17TP35G+47**YY	FSTP35G+47**YY	THTP35G+47**YY	F7TP35G+47**YY	T1TP35G+47**YY	T,Y			
				SLEEVE	T3TP35G+90**YY	17TP35G+90**YY	FSTP35G+90**YY	THTP35G+90**YY	F7TP35G+90**YY	T1TP35G+90**YY				
		POLY-PRO™	300	PRECISION	T3PP35G+42**YY	17PP35G+42**YY	FSP35G+42**YY	THPP35G+42**YY	F7PP35G+42**YY	T1PP35G+42**YY	K,W,P			
					T3PP35G+44**YY	17PP35G+44**YY	FSP35G+44**YY	THPP35G+44**YY	F7PP35G+44**YY	T1PP35G+44**YY	A,D,I,K,S			
				T3PP35G+47**YY	17PP35G+47**YY	FSP35G+47**YY	THPP35G+47**YY	F7PP35G+47**YY	T1PP35G+47**YY	T,Y				
				DELRIN	T3PP35G+55**YY	17PP35G+55**YY	FSP35G+55**YY	THPP35G+55**YY	F7PP35G+55**YY	T1PP35G+55**YY	K,W,P			
				SLEEVE	T3PP35G+90**YY	17PP35G+90**YY	FSP35G+90**YY	THPP35G+90**YY	F7PP35G+90**YY	T1PP35G+90**YY	T,Y			
		POLYMAC™	325	DELRIN	T3PM35GM5A**YY	17PM35GM5A**YY	FSPM35GM5A**YY	THPM35GM5A**YY	F7PM35GM5A**YY	T1PM35GM5A**YY				
		POLYON AL™	350	ANNULAR	T3PA35GL43**YY	17PA35GL43**YY	FSPA35GL43**YY	THPA35GL43**YY	F7PA35GL43**YY	T1PA35GL43**YY				
				HARD RUBBER	300	PLAIN	T3HR35GB82**YY	17HR35GB82**YY	FSHR35GB82**YY	THHR35GB82**YY	F7HR35GB82**YY	T1HR35GB82**YY		
		POLYOLEFIN	300	PLAIN	T3PO35GZ82**YY	17PO35GZ82**YY	FSP35GZ82**YY	THPO35GZ82**YY	F7PO35GZ82**YY	T1PO35GZ82**YY				
				SLEEVE	T3PO35GJ90**YY	17PO35GJ90**YY	FSP35GJ90**YY	THPO35GJ90**YY	F7PO35GJ90**YY	T1PO35GJ90**YY				
		4	1-4/4	YOKE AND AXLE/NUT				T3ZZ40GZ82**YAN	17ZZ40GZ82**YAN	FSZZ40GZ82**YAN	THZZ40GZ82**YAN	F7ZZ40GZ82**YAN	T1ZZ40GZ82**YAN	
				SOFT RUBBER	350	PLAIN	T3SR40GB82**YY	17SR40GB82**YY	FSSR40GB82**YY	THSR40GB82**YY	F7SR40GB82**YY	T1SR40GB82**YY		
						BALL	T3SR40GB42**YY	17SR40GB42**YY	FSSR40GB42**YY	THSR40GB42**YY	F7SR40GB42**YY	T1SR40GB42**YY		
				RUBBER/ALU	300	ANNULAR	T3RA40GI43**YY	17RA40GI43**YY	FARA40GI43**YY	THRA40GI43**YY	F7RA40GI43**YY	T1RA40GI43**YY		
						DELRIN	T3NM40GI5A**YY	17NM40GI5A**YY	FNM40GI5A**YY	THNM40GI5A**YY	F7NM40GI5A**YY	T1NM40GI5A**YY		
NOMADIC™	300			ANNULAR	T3NM40GI43**YY	17NM40GI43**YY	FNM40GI43**YY	THNM40GI43**YY	F7NM40GI43**YY	T1NM40GI43**YY				
				ANNULAR	T3NM40GI5A**YY	17NM40GI5A**YY	FNM40GI5A**YY	THNM40GI5A**YY	F7NM40GI5A**YY	T1NM40GI5A**YY				
CONDUCTIVE	250			PRECISION	T3CN40GH44**YY	17CN40GH44**YY	FSCN40GH44**YY	THCN40GH44**YY	F7CN40GH44**YY	T1CN40GH44**YY				
THERMO-PRO™	250			PRECISION	T3TP40GI44**YY	17TP40GI44**YY	FSTP40GI44**YY	THTP40GI44**YY	F7TP40GI44**YY	T1TP40GI44**YY				
				PRECISION	T3TP40G+47**YY	17TP40G+47**YY	FSTP40G+47**YY	THTP40G+47**YY	F7TP40G+47**YY	T1TP40G+47**YY	T,Y			
				SLEEVE	T3TP40G+90**YY	17TP40G+90**YY	FSTP40G+90**YY	THTP40G+90**YY	F7TP40G+90**YY	T1TP40G+90**YY	T,Y			
ELEMENT™	240			ANNULAR	T3EL40GI43**YY	17EL40GI43**YY	FSEL40GI43**YY	THEL40GI43**YY	F7EL40GI43**YY	T1EL40GI43**YY				
				BALL	T3PP40G+42**YY	17PP40G+42**YY	FSP40G+42**YY	THPP40G+42**YY	F7PP40G+42**YY	T1PP40G+42**YY	W,K,P			
POLY-PRO™	350			PRECISION	T3PP40G+44**YY	17PP40G+44**YY	FSP40G+44**YY	THPP40G+44**YY	F7PP40G+44**YY	T1PP40G+44**YY	A,D,I,K,S			
					T3PP40G+47**YY	17PP40G+47**YY	FSP40G+47**YY	THPP40G+47**YY	F7PP40G+47**YY	T1PP40G+47**YY	T,Y			
				DELRIN	T3PP40G+55**YY	17PP40G+55**YY	FSP40G+55**YY	THPP40G+55**YY	F7PP40G+55**YY	T1PP40G+55**YY	W,K			
				SLEEVE	T3PP40G+90**YY	17PP40G+90**YY	FSP40G+90**YY	THPP40G+90**YY	F7PP40G+90**YY	T1PP40G+90**YY	T,Y			
				DELRIN	T3PM40GM5A**YY	17PM40GM5A**YY	FSPM40GM5A**YY	THPM40GM5A**YY	F7PM40GM5A**YY	T1PM40GM5A**YY				
POLYMAC™	350			ANNULAR	T3PM40GM43**YY	17PM40GM43**YY	FSPM40GM43**YY	THPM40GM43**YY	F7PM40GM43**YY	T1PM40GM43**YY				



T1, T3, 17, FS, TH, F7 – TOTAL LOCK AND DIRECTIONAL LOCK – 350 LB

Wh. Dia.	Tread Width	Wheel Type	Load Cap.	Bearings Type	T3 Series Swivel Caster Part #	17 Series Swivel Caster Part #	FS Series Swivel Caster Part #	TH Series Swivel Caster Part #	F7 Series Swivel Caster Part #	T1 Series Swivel Caster Part #	Color	
4	1-4/4	DURA-LASTOMER™	350	SLEEVE	T3SU40GL90**YY	17SU40GL90**YY	FSSU40GL90**YY	THSU40GL90**YY	F7SU40GL90**YY	T1SU40GL90**YY		
		POLYON AL™	350	ANNULAR	T3PA40GL43**YY	17PA40GL43**YY	FSPA40GL43**YY	THPA40GL43**YY	F7PA40GL43**YY	T1PA40GL43**YY		
		DISC WHEEL	250	BALL	T3UN40GL43**YY	17UN40GL43**YY	FSUN40GL43**YY	THUN40GL43**YY	F7UN40GL43**YY	T1UN40GL43**YY		
		HARD RUBBER	350	PLAIN	T3HR40GB82**YY	17HR40GB82**YY	FSHR40GB82**YY	THHR40GB82**YY	F7HR40GB82**YY	T1HR40GB82**YY		
				BALL	T3HR40GB42**YY	17HR40GB42**YY	FSHR40GB42**YY	THHR40GB42**YY	F7HR40GB42**YY	T1HR40GB42**YY		
		POLYOLEFIN	350	PLAIN	T3PO40G+82**YY	17PO40G+82**YY	FSP040G+82**YY	THPO40G+82**YY	F7PO40G+82**YY	T1PO40G+82**YY	B,Z	
				SLEEVE	T3PO40G+90**YY	17PO40G+90**YY	FSP040G+90**YY	THPO40G+90**YY	F7PO40G+90**YY	T1PO40G+90**YY	J,Z	
				BALL	T3PO40GZ42**YY	17PO40GZ42**YY	FSP040GZ42**YY	THPO40GZ42**YY	F7PO40GZ42**YY	T1PO40GZ42**YY		
		H.D. POLYOLEFIN	350	PLAIN	T3HP40G+82**YY	17HP40G+82**YY	FSP40G+82**YY	THHP40G+82**YY	F7HP40G+82**YY	T1HP40G+82**YY	B,E	
		NYLON	350	PRECISION	T3NY40GE47**YY	17NY40GE47**YY	FSNY40GE47**YY	THNY40GE47**YY	F7NY40GE47**YY	T1NY40GE47**YY		
	SLEEVE			T3NY40GE90**YY	17NY40GE90**YY	FSNY40GE90**YY	THNY40GE90**YY	F7NY40GE90**YY	T1NY40GE90**YY			
	STEROLLIZER® AL	300	SLEEVE	T3BF40GC97**YY	17BF40GC97**YY	F3BF40GC97**YY	THBF40GC97**YY	F7BF40GC97**YY	T1BF40GC97**YY			
	STEROLLIZER® SS	300	SLEEVE	T3SL40GC83**YY	17SL40GC83**YY	F3SL40GC83**YY	THSL40GC83**YY	F7SL40GC83**YY	T1SL40GC83**YY			
	1-1/2	POLYON®	350	ROLLER	T3PU40H+03**YZ	17PU40H+03**YZ	F3PU40H+03**YZ	THPU40H+03**YZ	F7PU40H+03**YZ	T1PU40H+03**YZ	G,V	
		POLYON AL™	350	ROLLER	T3PA40H+03**YZ	17PA40H+03**YZ	F3PA40H+03**YZ	THPA40H+03**YZ	F7PA40H+03**YZ	T1PA40H+03**YZ	N,R	
		POLYOLEFIN	350	ROLLER	T3PO40HB03**YZ	17PO40HB03**YZ	F3PO40HB03**YZ	THPO40HB03**YZ	F7PO40HB03**YZ	T1PO40HB03**YZ		
		STEROLLIZER® AL	350	SS PRECISION	T3BH40HC61**YY	17BH40HC61**YY	F3BH40HC61**YY	THBH40HC61**YY	F7BH40HC61**YY	T1BH40HC61**YY		
	STEROLLIZER® SS	350	SS PRECISION	T3SL40HC61**YY	17SL40HC61**YY	F3SL40HC61**YY	THSL40HC61**YY	F7SL40HC61**YY	T1SL40HC61**YY			
	5	1-1/4	YOKE AND AXLE/NUT			T3ZZ50GZ82**YAN	17ZZ50GZ82**YAN	F3ZZ50GZ82**YAN	THZZ50GZ82**YAN	F7ZZ50GZ82**YAN	T1ZZ50GZ82**YAN	
			SOFT RUBBER	350	PLAIN	T3SR50GB82**YY	17SR50GB82**YY	F3SR50GB82**YY	THSR50GB82**YY	F7SR50GB82**YY	T1SR50GB82**YY	
BALL					T3SR50GB42**YY	17SR50GB42**YY	F3SR50GB42**YY	THSR50GB42**YY	F7SR50GB42**YY	T1SR50GB42**YY		
RUBBER/ALU			275	ANNULAR	T3RA50GI43**YY	17RA50GI43**YY	F3RA50GI43**YY	THRA50GI43**YY	F7RA50GI43**YY	T1RA50GI43**YY		
				DELTRIN	T3NM50GI5A**YY	17NM50GI5A**YY	F3NM50GI5A**YY	THNM50GI5A**YY	F7NM50GI5A**YY	T1NM50GI5A**YY		
NOMADIC™			325	ANNULAR	T3NM50GI43**YY	17NM50GI43**YY	F3NM50GI43**YY	THNM50GI43**YY	F7NM50GI43**YY	T1NM50GI43**YY		
				CONDUCTIVE	275	PRECISION	T3CN50GH44**YY	17CN50GH44**YY	F3CN50GH44**YY	THCN50GH44**YY	F7CN50GH44**YY	T1CN50GH44**YY
THERMO-PRO™			300	PRECISION	T3TP50GI44**YY	17TP50GI44**YY	F3TP50GI44**YY	THTP50GI44**YY	F7TP50GI44**YY	T1TP50GI44**YY		
				PRECISION	T3TP50G+47**YY	17TP50G+47**YY	F3TP50G+47**YY	THTP50G+47**YY	F7TP50G+47**YY	T1TP50G+47**YY	T,Y	
				SLEEVE	T3TP50G+90**YY	17TP50G+90**YY	F3TP50G+90**YY	THTP50G+90**YY	F7TP50G+90**YY	T1TP50G+90**YY		
ELEMENT™		250	ANNULAR	T3EL50GI43**YY	17EL50GI43**YY	F3EL50GI43**YY	THEL50GI43**YY	F5EL50GI43**YY	T1EL50GI43**YY			
			BALL	T3PP50G+42**YY	17PP50G+42**YY	F3PP50G+42**YY	THPP50G+42**YY	F7PP50G+42**YY	T1PP50G+42**YY	C,K,PW		
POLY-PRO™		350	PRECISION	T3PP50G+44**YY	17PP50G+44**YY	F3PP50G+44**YY	THPP50G+44**YY	F7PP50G+44**YY	T1PP50G+44**YY	I,A,D,S		
			PRECISION	T3PP50G+47**YY	17PP50G+47**YY	F3PP50G+47**YY	THPP50G+47**YY	F7PP50G+47**YY	T1PP50G+47**YY	T,Y		
			DELTRIN	T3PP50G+55**YY	17PP50G+55**YY	F3PP50G+55**YY	THPP50G+55**YY	F7PP50G+55**YY	T1PP50G+55**YY	C,K,PW		
			SLEEVE	T3PP50G+90**YY	17PP50G+90**YY	F3PP50G+90**YY	THPP50G+90**YY	F7PP50G+90**YY	T1PP50G+90**YY	T,Y		
POLYMAC™		350	DELTRIN	T3PM50GM5A**YY	17PM50GM5A**YY	F3PM50GM5A**YY	THPM50GM5A**YY	F7PM50GM5A**YY	T1PM50GM5A**YY			
			ANNULAR	T3PM50GM43**YY	17PM50GM43**YY	F3PM50GM43**YY	THPM50GM43**YY	F7PM50GM43**YY	T1PM50GM43**YY			
DURA-LASTOMER™		350	SLEEVE	T3SU50GL90**YY	17SU50GL90**YY	F3SU50GL90**YY	THSU50GL90**YY	F7SU50GL90**YY	T1SU50GL90**YY			
POLYON AL™		350	ANNULAR	T3PA50GL43**YY	17PA50GL43**YY	F3PA50GL43**YY	THPA50GL43**YY	F7PA50GL43**YY	T1PA50GL43**YY			
DISC WHEEL	300	BALL	T3UN50GL43**YY	17UN50GL43**YY	FSUN50GL43**YY	THUN50GL43**YY	F7UN50GL43**YY	T1UN50GL43**YY				
HARD RUBBER	350	PLAIN	T3HR50GB82**YY	17HR50GB82**YY	FSHR50GB82**YY	THHR50GB82**YY	F7HR50GB82**YY	T1HR50GB82**YY				
		BALL	T3HR50GB42**YY	17HR50GB42**YY	FSHR50GB42**YY	THHR50GB42**YY	F7HR50GB42**YY	T1HR50GB42**YY				
POLYOLEFIN	350	PLAIN	T3PO50G+82**YY	17PO50G+82**YY	F3PO50G+82**YY	THPO50G+82**YY	F7PO50G+82**YY	T1PO50G+82**YY	B,Z			
		SLEEVE	T3PO50G+90**YY	17PO50G+90**YY	F3PO50G+90**YY	THPO50G+90**YY	F7PO50G+90**YY	T1PO50G+90**YY	J,Z			
		BALL	T3PO50GZ42**YY	17PO50GZ42**YY	F3PO50GZ42**YY	THPO50GZ42**YY	F7PO50GZ42**YY	T1PO50GZ42**YY				
H.D. POLYOLEFIN	350	PLAIN	T3HP50G+82**YY	17HP50G+82**YY	F3HP50G+82**YY	THHP50G+82**YY	F7HP50G+82**YY	T1HP50G+82**YY	B,E			
NYLON	350	PRECISION	T3NY50GE47**YY	17NY50GE47**YY	FSNY50GE47**YY	THNY50GE47**YY	F7NY50GE47**YY	T1NY50GE47**YY				
		SLEEVE	T3NY50GE90**YY	17NY50GE90**YY	FSNY50GE90**YY	THNY50GE90**YY	F7NY50GE90**YY	T1NY50GE90**YY				
6	1-1/4	POLY-PRO™	350	PRECISION	T3PP60G+44**YY						A,I	
				DELTRIN	T3PP60GI55**YY							T,Y
				SLEEVE	T3PP60GT90**YY							
		THERMO-PRO™	300	PRECISION	T3TP60GI44**YY							
SLEEVE	T3TP60GT47**YY											



# DURABLE SUPERIOR CASTERS®

## WHEEL TYPE OPTIONS

Hard Rubber	Soft Rubber	Cushion Ride™	Cushion Ride™	Rubber on Aluminum	Nomadic™	Polymadic™	Dura Lastomer®	Poly-AL™ (L)	Poly-AL™ (N)	Poly-AL™ (R)	
Polyolefin	Polyolefin Donut	Polyolefin Donut	HD Polyolefin	Nylon	Phenolic	H. T. Phenolic High Temp	BrimSton® High Temp	Sterollizer AL® High Temp	Semi-Steel	Sintered Iron	

## WHEEL COLOR OPTIONS









Thermo-Pro™					Poly-Pro™										
Flat Tread				Round	Flat Tread										Round
A	B	I	T	Y	A	D	I	K	P	S	T	V	W	Y	

## BEARING, HUB AND THREAD GUARD DESIGNS

42, 51, 52, 53 Ball Bearings	44 Precision Ball Bearings	47 Precision Ball Bearings	83 Plain Bore	88 Bore with Bushing

## CHOOSING THE RIGHT WHEEL BEARINGS FOR YOUR APPLICATION

*When multiple bearing choices exist, replace ## in part # with desired bearing code.*

ROLLER BEARING	CAGED ROLLER BEARING	TAPERED ROLLER BEARING	SEALED PRECISION BEARINGS	DELRIN BEARINGS - 1 PIECE DESIGN
 <p>Standard bearing for general duty applications; cost effective, best bearing for abusive and shock load applications. Not recommended for applications where side thrust is present or on casters used in constant circular turns. Requires periodical lubrication.</p>	 <p>Roller bearing with encased outer raceway, capable of taking more abuse than standard roller bearings with split outer raceway. Requires periodical lubrication. Acceptable for high temperature applications when used with metal retainer washers. Costs more than standard roller bearings.</p>	 <p>Heaviest duty type of roller bearings with the added advantage of tapered design. Inner and outer raceways are precision machined and heat treated. Wheels come with 1 cup, cone, seal and thrust bushing on each side. This is the best bearing for extreme duty loads and towing applications. Maximizes the weight capacity and mobility of the wheel. Requires periodical lubrication.</p>	 <p><b>(63, 64) Sealed Precision Bearings</b> Ergonomic solution: These are the best precision bearings out of the 3 types we offer; and come with top hat bushings that provide precise spacing and stability. They offer low rolling resistance and require the least amount of force to start and maintain a rolling load; excellent for both manual mobility and tow line applications. Maintenance Free! Not recommended for side thrust or shock load applications.</p>  <p><b>(60) Sealed Precision Radial BB</b> Ergonomic solution: Precision radial BB can be used in any non-metal hub wheels. Offers low rolling resistance, easy load start up and requires minimal effort to continue rolling a load. Maintenance free. Not recommended for side thrust or shock load applications.</p>  <p><b>(48) Dual-Row Sealed Annular Bearings</b> Ergonomic solution: Dual row sealed annular bearings offer low rolling resistance, easy load start up and requires minimal effort to continue rolling a load. Bearings are maintenance free. Not recommended for side thrust or shock load applications. Weight capacity of bearing is 900 lbs.</p>  <p><b>(96) Bronze Bearing, 3/4 Bore with Bushing to 1/2</b> Maintenance free bearing, highly resistant to corrosion, wear and capable of operating in high temperature applications.</p>	<p>Maintenance free and has no moving parts to break, good for wash downs, strong and economical, offers minimal mobility. Bearings with bushing provides more stability, (57) is the most popular.</p>  <p>(11) 1 piece bearing with bushing (12) 1 piece bearing plain bore</p>  <p><b>Delrin Bearings - 2 Piece Flanged</b> (56) 2 piece flanged bearing (57) 2 piece flanged bearing with bushing</p> <p><b>(88) Plain Bore 3/4 with Bushing to 1/2</b> Has no moving parts to break, good for wash down applications, strong and economical, offers minimal mobility. May or may not lubricate.</p>

**07/17/75/T3/FS/76 – MODULAR STEM, HOLLOW KINGPIN, SWIVEL TOTAL LOCK – 350LB NSF NEW**



- Dual raceway
- 1/2" hollow kingpin
- Bright zinc as standard, nickel, chrome and black e-coat are available
- Majority are NSF listed

BRAKE OPTIONS			
Vertical Top Lock (V)	Tech Lock Pedal Brake (H)	Top Lock Brake (T)	TPK Brake Kit

OTHER OPTIONS	
Thread Guards	G
High Temp Grease	K
Zerk Axle	Z

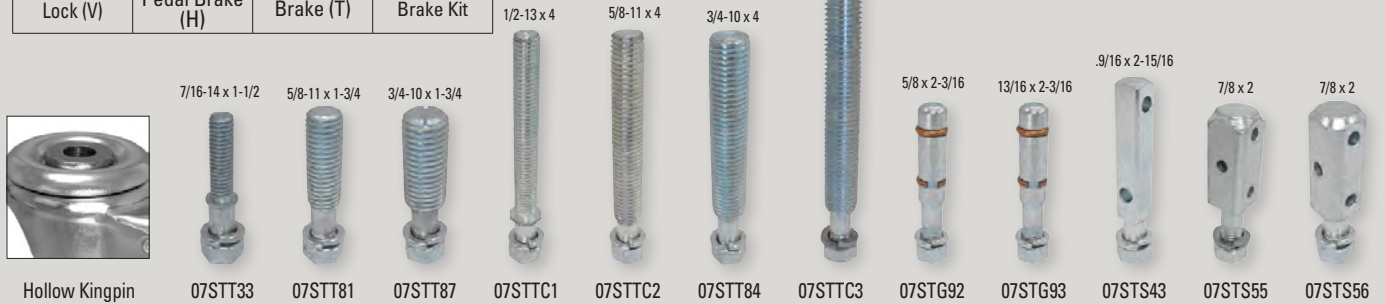

FASTENING OPTIONS							
Replace ** in part # with desired plat or stem code. Order modular stems installed with stem code – or uninstalled by part #.							
Stem Code	Size	Stem Type	Modular Part #	Stem Code	Size	Stem Type	Modular Part #
91	7/16 X 1-3/8	GRIP RING	07STG91	33	7/16-14X1-1/2	THREADED	07STT33
85	1 X 2-3/16	DUAL GRIP RING	07STG85	79	7/16-14X2-1/4		07STT79
92	5/8 X 2-3/16	DUAL GRIP RING	07STG92	C4	1/2-13X2-3/4		07STTC4
93	13/16 X 2-3/16	DUAL GRIP RING	07STG93	C8	1/2-13X3-1/8		07STTC8
95	.846 X 2-3/4	GRIP RING	07STG95	C1	1/2-13X4		07STTC1
48	0.865 X 2-1/4	DUAL GRIP RING	07STG48	88	3/4-10X1		07STTS88
82	1-1/8" X 2-3/16	DUAL GRIP RING	07STG82	87	3/4-10X1-3/4		07STT87
22	1-1/4" X 2-3/16	DUAL GRIP RING	07STG22	84	3/4-10X4		07STT84
23	1-3/8 X 2-3/16	DUAL GRIP RING	07STG23	C3	3/4-10X6		07STTC3
41	0.875 X 2-1/4	OCTAGON GRIP RING	07STO41	80	5/8-11X1		07STT80
43	9/16 X 2-15/16	SQUARE 2 CROSS HOLES 5/16"	07STS43	81	5/8-11X1-3/4		07STT81
51	3/4 X 2	OCTAGON, W/ 3 CROSS DRILL 1/4"	07STS51	C2	5/8-11X4		07STTC2
55	7/8 X 2	SQUARE 3 CROSS HOLES	07STS55	C5	5/8-11X2.25		07STTC5
56	7/8 X 2	OCTAGON 3 CROSS HOLES	07STS56	F1	ADJUSTING RANGE 1.75" - 2.375"		07STAF1
E1		ADJUSTING RANGE 1.75" - 2.375"	07STAE1	F2	ADJUSTING RANGE 1.875" - 2.5"		07STAF2
E2		ADJUSTING RANGE 1.875" - 2.5"	07STAE2	F3	ADJUSTING RANGE 3.5" - 4.125"		07STAF3
E3		ADJUSTING RANGE 3.5" - 4.125"	07STAE3	F4	ADJUSTING RANGE 3.5" - 5"	07STAF4	
E4		ADJUSTING RANGE 3.5" - 5"	07STAE4	ZZ	ADJUSTING RANGE 3.5" - 5"	N/A	
B1	1.49" X 1-7/8"	ADJUSTABLE RANGE 1.78" TO 3" FOR 1.5" TUBING	07STGB1				

\*#55 stem diagonal cross section is 1.087" and 56 stem diagonal cross section is 0.983

CASTER OVERALL HEIGHT AND SWIVEL RADIUS										
Wheel Diameter	07 Series Swivel Caster		17 Series Swivel Caster		75 Series Swivel Caster		T3 Series Swivel Caster		FS Series Swivel Caster	
	Overall H.	Swivel R.	Overall H.	Swivel R.	Overall H.	Swivel R.	Overall H.	Swivel R.	Overall H.	Swivel R.
3"	4	3	4-1/8		4	2-7/8	4		4-1/16	
3-1/2"	4-1/2	3-3/16	4-5/8	4-7/8	4-1/2	3-1/8	4-1/2	4-7/8		4-5/8
4"	5	3-1/2	5-1/8		5	3-3/8	5			
5"	6	4	6-1/8		6-1/8	3-7/8	6-1/8			
6"					7	4	7			
6-1/4"					7-1/8	4-1/8				



# DURABLE SUPERIOR CASTERS®

07/17/75/T3/FS/76 – MODULAR STEM, HOLLOW KINGPIN, SWIVEL TOTAL LOCK SERIES – 350LB

Wh. Dia.	Tread Width	Wheel Type	Load Cap.	Bearings Type	07 Series Swivel Caster Part #	17 Series Swivel Caster Part #	75 Series Swivel Caster Part #	T3 Series Swivel Caster Part #	FS Series Swivel Caster Part #	76 Series Rigid Caster Part #	Color	
3	1-1/4	YOKE AND AXLE/NUT				07ZZ30GZ82ZZYAN	17ZZ30GZ82ZZYAN	75ZZ30GZ82ZZYAN	T3ZZ30GZ82ZZYAN	FSZZ30GZ82ZZYAN	76ZZ30GZ82ZZYAN	
		SOFT RUBBER	300	PLAIN	07SR30GB82**YY	17SR30GB82**YY	75SR30GB82**YY	T3SR30GB82**YY	FSSR30GB82**YY	76SR30GB82**YY		
				BALL	07SR30GB42**YY	17SR30GB42**YY	75SR30GB42**YY	T3SR30GB42**YY	FSSR30GB42**YY	76SR30GB42**YY		
		NOMADIC™	300	DELTRIN	07NM30GI5A**YY	17NM30GI5A**YY	75NM30GI5A**YY	T3NM30GI5A**YY	FSNM30GI5A**YY	76NM30GI5A**YY		
				ANNULAR	07NM30GI43**YY	17NM30GI43**YY	75NM30GI43**YY	T3NM30GI43**YY	FSNM30GI43**YY	76NM30GI43**YY		
		CONDUCTIVE TPR	200	PRECISION	07CN30GH44**YY	17CN30GH44**YY	75CN30GH44**YY	T3CN30GH44**YY	FSCN30GH44**YY	76CN30GH44**YY		
		CONDUCTIVE SR	250	BALL	07CT30GB42**YY	17CT30GB42**YY	75CT30GB42**YY	T3CT30GB42**YY	FSCT30GB42**YY	76CT30GB42**YY		
		THERMO-PRO™	210	PRECISION	07TP30GI44**YY	17TP30GI44**YY	75TP30GI44**YY	T3TP30GI44**YY	FSTP30GI44**YY	76TP30GI44**YY		
				PRECISION SLEEVE	07TP30G+47**YY	17TP30G+47**YY	75TP30G+47**YY	T3TP30G+47**YY	FSTP30G+47**YY	76TP30G+47**YY	T, Y	
		ELEMENT™	210	ANNULAR	07EL30GI43**YY	17EL30GI43**YY	75EL30GI43**YY	T3EL30GI43**YY	FSEL30GI43**YY	76EL30GI43**YY		
				BALL	07PP30G+42**YY	17PP30G+42**YY	75PP30G+42**YY	T3PP30G+42**YY	FSP30G+42**YY	76PP30G+42**YY	K, W	
		POLY-PRO™	300	PRECISION	07PP30G+44**YY	17PP30G+44**YY	75PP30G+44**YY	T3PP30G+44**YY	FSP30G+44**YY	76PP30G+44**YY	A, D, I, K, S	
					07PP30G+47**YY	17PP30G+47**YY	75PP30G+47**YY	T3PP30G+47**YY	FSP30G+47**YY	76PP30G+47**YY	T, Y	
				DELTRIN	07PP30G+55**YY	17PP30G+55**YY	75PP30G+55**YY	T3PP30G+55**YY	FSP30G+55**YY	76PP30G+55**YY	K, W, P	
				SLEEVE	07PP30G+90**YY	17PP30G+90**YY	75PP30G+90**YY	T3PP30G+90**YY	FSP30G+90**YY	76PP30G+90**YY	T, Y	
		POLYMAC™	300	DELTRIN	07PM30GM5A**YY	17PM30GM5A**YY	75PM30GM5A**YY	T3PM30GM5A**YY	FSPM30GM5A**YY	76PM30GM5A**YY		
				ANNULAR	07PM30GM43**YY	17PM30GM43**YY	75PM30GM43**YY	T3PM30GM43**YY	FSPM30GM43**YY	76PM30GM43**YY		
		DURA-LASTOMER™	300	SLEEVE	07SU30GL90**YY	17SU30GL90**YY	75SU30GL90**YY	T3SU30GL90**YY	FSSU30GL90**YY	76SU30GL90**YY		
		POLYON AL™	350	ANNULAR	07PA30GL43**YY	17PA30GL43**YY	75PA30GL43**YY	T3PA30GL43**YY	FSPA30GL43**YY	76PA30GL43**YY		
		HARD RUBBER	300	BALL	07HR30GB42**YY	17HR30GB42**YY	75HR30GB42**YY	T3HR30GB42**YY	FSHR30GB42**YY	76HR30GB42**YY		
				PLAIN	07HR30GB82**YY	17HR30GB82**YY	75HR30GB82**YY	T3HR30GB82**YY	FSHR30GB82**YY	76HR30GB82**YY		
		GRAYROK™	300	PLAIN	07RK30GI82**YY	17RK30GI82**YY	75RK30GI82**YY	T3RK30GI82**YY	FSRK30GI82**YY	76RK30GI82**YY		
				250	PLAIN	07PO30G+82**YY	17PO30G+82**YY	75PO30G+82**YY	T3PO30G+82**YY	FSP30G+82**YY	76PO30G+82**YY	B, Z
		POLYOLEFIN	300	SLEEVE	07PO30G+90**YY	17PO30G+90**YY	75PO30G+90**YY	T3PO30G+90**YY	FSP30G+90**YY	76PO30G+90**YY	J, Z	
				BALL	07PO30GZ42**YY	17PO30GZ42**YY	75PO30GZ42**YY	T3PO30GZ42**YY	FSP30GZ42**YY	76PO30GZ42**YY		
				H. D. POLYOLEFIN NYLON	300	PLAIN	07HP30G+82**YY	17HP30G+82**YY	75HP30G+82**YY	T3HP30G+82**YY	FSHP30G+82**YY	76HP30G+82**YY
			300	SLEEVE	07NY30GE90**YY	17NY30GE90**YY	75NY30GE90**YY	T3NY30GE90**YY	FSNY30GE90**YY	76NY30GE90**YY		
			300	PRECISION	07NY30GE47**YY	17NY30GE47**YY	75NY30GE47**YY	T3NY30GE47**YY	FSNY30GE47**YY	76NY30GE47**YY		
		PHENOLIC	300	TOP HEAD	07PH30GB99**YY		75PH30GB99**YY			76PH30GB99**YY		
		HIGH-TEMP PHENOLIC	200	S. S. TOP HEAD	07HT30GQ97**YY		75HT30GQ97**YY			76HT30GQ97**YY		
		BRIMSTONE®	350	S. S. TOP HEAD	07GN30GQ97**YY		75GN30GQ97**YY			76GN30GQ97**YY		
		SEMI-STEEL	350	PLAIN	07SS30GS82**YY		75SS30GS82**YY			76SS30GS82**YY		
				SLEEVE	07SS30GS90**YY		75SS30GS90**YY			76SS30GS90**YY		
		SINTERED IRON	350	PLAIN	07SI30GS82**YY		75SI30GS82**YY			76SI30GS82**YY		
V-GROOVE	350	PLAIN	07VG30GT82**YY		75VG30GT82**YY			76VG30GT82**YY				
1-1/2	PHENOLIC	SLEEVE	07PH30GB90**YY		75PH30GB90**YY			76PH30GB90**YY				
		ROLLER	07PH30HB03**YZ		75PH30HB03**YZ			76PH30HB03**YZ				
3-1/2	1-1/4	YOKE AND AXLE/NUT				07ZZ35GZ82ZZYAN	17ZZ35GZ82ZZYAN	75ZZ35GZ82ZZYAN	T3ZZ35GZ82ZZYAN	FSZZ35GZ82ZZYAN	76ZZ35GZ82ZZYAN	
		SOFT RUBBER	350	PLAIN	07SR35GB82**YY	17SR35GB82**YY	75SR35GB82**YY	T3SR35GB82**YY	FSSR35GB82**YY	76SR35GB82**YY		
		RUBBER/ALU	300	ANNULAR	07RA35GI43**YY	17RA35GI43**YY	75RA35GI43**YY	T3RA35GI43**YY	FSRA35GI43**YY	76RA35GI43**YY		
		NOMADIC™	300	DELTRIN	07NM35GI5A**YY	17NM35GI5A**YY	75NM35GI5A**YY	T3NM35GI5A**YY	FSNM35GI5A**YY	76NM35GI5A**YY		
				ANNULAR	07NM35GI43**YY	17NM35GI43**YY	75NM35GI43**YY	T3NM35GI43**YY	FSNM35GI43**YY	76NM35GI43**YY		
		THERMO-PRO™	230	PRECISION	07TP35GI44**YY	17TP35GI44**YY	75TP35GI44**YY	T3TP35GI44**YY	FSTP35GI44**YY	76TP35GI44**YY		
				SLEEVE	07TP35G+47**YY	17TP35G+47**YY	75TP35G+47**YY	T3TP35G+47**YY	FSTP35G+47**YY	76TP35G+47**YY	T, Y	
		ELEMENT™	220	ANNULAR	07EL35GI43**YY	17EL35GI43**YY	75EL35GI43**YY	T3EL35GI43**YY	FSEL35GI43**YY	76EL35GI43**YY		
				BALL	07PP35G+42**YY	17PP35G+42**YY	75PP35G+42**YY	T3PP35G+42**YY	FSP35G+42**YY	76PP35G+42**YY	K, W, P	
		POLY-PRO™	300	PRECISION	07PP35G+44**YY	17PP35G+44**YY	75PP35G+44**YY	T3PP35G+44**YY	FSP35G+44**YY	76PP35G+44**YY	A, D, I, K, S	
					07PP35G+47**YY	17PP35G+47**YY	75PP35G+47**YY	T3PP35G+47**YY	FSP35G+47**YY	76PP35G+47**YY	T, Y	
				DELTRIN	07PP35G+55**YY	17PP35G+55**YY	75PP35G+55**YY	T3PP35G+55**YY	FSP35G+55**YY	76PP35G+55**YY	K, W, P	
				SLEEVE	07PP35G+90**YY	17PP35G+90**YY	75PP35G+90**YY	T3PP35G+90**YY	FSP35G+90**YY	76PP35G+90**YY	T, Y	
		POLYMAC™	325	DELTRIN	07PM35GM43**YY	17PM35GM43**YY	75PM35GM43**YY	T3PM35GM43**YY	FSPM35GM43**YY	76PM35GM43**YY		
				ANNULAR	07PM35GM43**YY	17PM35GM43**YY	75PM35GM43**YY	T3PM35GM43**YY	FSPM35GM43**YY	76PM35GM43**YY		
		POLYON AL™	350	ANNULAR	07PA35GL43**YY	17PA35GL43**YY	75PA35GL43**YY	T3PA35GL43**YY	FSPA35GL43**YY	76PA35GL43**YY		
		DISC WHEEL	250	BALL	07UN35GLA3**YY	17UN35GLA3**YY	75UN35GLA3**YY	T3UN35GLA3**YY	FSUN35GLA3**YY	76UN35GLA3**YY		
		HARD RUBBER	300	PLAIN	07HR35GB82**YY	17HR35GB82**YY	75HR35GB82**YY	T3HR35GB82**YY	FSHR35GB82**YY	76HR35GB82**YY		
		POLYOLEFIN	300	PLAIN	07PO35GZ82**YY	17PO35GZ82**YY	75PO35GZ82**YY	T3PO35GZ82**YY	FSP35GZ82**YY	76PO35GZ82**YY		
				SLEEVE	07PO35GJ90**YY	17PO35GJ90**YY	75PO35GJ90**YY	T3PO35GJ90**YY	FSP35GJ90**YY	76PO35GJ90**YY		
		PHENOLIC	350	TOP HEAD	07PH35GB99**YY		75PH35GB99**YY			76PH35GB99**YY		
		SEMI-STEEL	350	PLAIN	07SS35GS82**YY		75SS35GS82**YY			76SS35GS82**YY		





# DURABLE SUPERIOR CASTERS®

07/17/75/T3/FS/76 – MODULAR STEM, HOLLOW KINGPIN, SWIVEL TOTAL LOCK SERIES – 350LB

Wh. Dia.	Tread Width	Wheel Type	Load Cap.	Bearings Type	07 Series Swivel Caster Part #	17 Series Swivel Caster Part #	75 Series Swivel Caster Part #	T3 Series Swivel Caster Part #	FS Series Swivel Caster Part #	76 Series Rigid Caster Part #	Color	
5	1-1/4	POLY-PRO™	350	DELTRIN	07PP50G+55**YY	17PP50G+55**YY	75PP50G+55**YY	T3PP50G+55**YY	FSP50G+55**YY	76PP50G+55**YY	C, K, P, W	
		POLY-PRO™	350	SLEEVE	07PP50G+90**YY	17PP50G+90**YY	75PP50G+90**YY	T3PP50G+90**YY	FSP50G+90**YY	76PP50G+90**YY	T, Y	
		POLYMAC™	350	DELTRIN	07PM50GM5A**YY	17PM50GM5A**YY	75PM50GM5A**YY	T3PM50GM5A**YY	FSPM50GM5A**YY	76PM50GM5A**YY		
				ANNULAR	07PM50GM43**YY	17PM50GM43**YY	75PM50GM43**YY	T3PM50GM43**YY	FSPM50GM43**YY	76PM50GM43**YY		
		DURA-LASTOMER™	350	SLEEVE	07SU50GL90**YY	17SU50GL90**YY	75SU50GL90**YY	T3SU50GL90**YY	FSSU50GL90**YY	76SU50GL90**YY		
		POLYON AL™	350	ANNULAR	07PA50GL43**YY	17PA50GL43**YY	75PA50GL43**YY	T3PA50GL43**YY	FSPA50GL43**YY	76PA50GL43**YY		
		DISC WHEEL	300	BALL	07UN50GLA3**YY	17UN50GLA3**YY	75UN50GLA3**YY	T3UN50GLA3**YY	FSUN50GLA3**YY	76UN50GLA3**YY		
		HARD RUBBER	350	PLAIN	07HR50GB82**YY	17HR50GB82**YY	75HR50GB82**YY	T3HR50GB82**YY	FSHR50GB82**YY	76HR50GB82**YY		
				BALL	07HR50GB42**YY	17HR50GB42**YY	75HR50GB42**YY	T3HR50GB42**YY	FSHR50GB42**YY	76HR50GB42**YY		
		POLYOLEFIN	350	PLAIN	07PO50G+82**YY	17PO50G+82**YY	75PO50G+82**YY	T3PO50G+82**YY	FSP050G+82**YY	76PO50G+82**YY	B, Z	
				SLEEVE	07PO50G+90**YY	17PO50G+90**YY	75PO50G+90**YY	T3PO50G+90**YY	FSP050G+90**YY	76PO50G+90**YY	J, Z	
				BALL	07PO50GZ42**YY	17PO50GZ42**YY	75PO50GZ42**YY	T3PO50GZ42**YY	FSP050GZ42**YY	76PO50GZ42**YY		
		H. D. POLYOLEFIN	350	PLAIN	07HP50G+82**YY	17HP50G+82**YY	75HP50G+82**YY	T3HP50G+82**YY	FSHP50G+82**YY	76HP50G+82**YY	B, E	
		NYLON	350	PRECISION	07NY50GE47**YY	17NY50GE47**YY	75NY50GE47**YY	T3NY50GE47**YY	FSNY50GE47**YY	76NY50GE47**YY		
				SLEEVE	07NY50GE90**YY	17NY50GE90**YY	75NY50GE90**YY	T3NY50GE90**YY	FSNY50GE90**YY	76NY50GE90**YY		
		PHENOLIC	350	TOP HEAD	07PH50GB99**YY		75PH50GB99**YY			76PH50GB99**YY		
		HIGH-TEMP PHENOLIC	300	S. S. TOP HEAD	07HT50GQ97**YY		75HT50GQ97**YY			76HT50GQ97**YY		
		BRIMSTONE®	350	S. S. TOP HEAD	07GN50GQ97**YY		75GN50GQ97**YY			76GN50GQ97**YY		
		SEMI-STEEL	350	PLAIN	07SS50GS82**YY		75SS50GS82**YY			76SS50GS82**YY		
				SLEEVE	07SS50GS90**YY		75SS50GS90**YY			76SS50GS90**YY		
6	1-1/4	YOKE AND AXLE/NUT						75ZZ60GZ82**YY	T3ZZ60GZ82**YY			
		POLY-PRO™	350	PRECISION			75PP60G+44**YY	T3PP60G+44**YY				A, I
				DELTRIN			75PP60G+47**YY	T3PP60G+47**YY				T, Y
				SLEEVE			75PP60GI55**YY	T3PP60GI55**YY				
		THERMO-PRO™	300	PRECISION			75TP60GI44**YY	T3TP60GI44**YY				
				SLEEVE			75TP60GT47**YY	T3TP60GT47**YY				
		SEMI-STEEL	350	PLAIN			75TP60GT90**YY	T3TP60GT90**YY				
				SLEEVE								
6-1/4	1-1/4	CUSHION-RIDE™	200	BALL			75CR60G+42**YY				A, I	

WHEEL TYPE OPTIONS										
Hard Rubber	Soft Rubber	Cushion Ride™ (A)	Cushion Ride™ (I)	Rubber on Aluminum	Nomadic™	Polymadic™	Dura Lastomer®	Poly-AL™ (L)	Polyolefin (B)	Polyolefin Donut (Z)
Blue Nomadic	Polyolefin Donut (J)	H. D. Polyolefin	Nylon	Phenolic	H. T. Phenolic High Temp	BrimSton® High Temp	Sterollizer AL® High Temp	Semi-Steel	Sintered Iron	V-Groove

# 79/80/T9 – STAMP-FORMED SERIES – 450LB



- Stamp formed body for attractive appearance
- The series includes swivel, rigid and matching total lock
- 8" rigid caster available with plate welded 90° direction

BRAKE OPTIONS		OTHER OPTIONS	
Total-Lock Pedal Brake (T9) prefix. Not available with 17 plate.	Vertical Top Lock (V)	Thread Guards (G)	Top Plate Turned 90° [8" Rigid only] (90)

### FASTENING OPTIONS

Replace \*\* in part # with desired plate or stem code.

Plate Code	Overall Size	Bolt Hole Pattern	Mounting Bolt Diameter
06	2-3/8 X 3-5/8	1-3/4 X 2-7/8 SLOTTED TO 3	5/16
90	2-3/8 X 3-5/8 (LEG 90° ROTATE WELDED)	1-3/4 X 2-7/8 SLOTTED TO 3	5/16
11	3-1/8 X 4-1/8	1-3/4 X 2-15/16 TO 2-3/8 X 3-3/8	3/8
17	4 X 4-1/2	2-5/8 X 3-5/8 TO 3 X 3	3/8
MS	3-1/8 X 3-3/4	1-5/8 X 3 TO 2-5/16 X 3-1/8	5/16

Stem Code	Size	Stem Type	Stem Code	Size	Stem Type
67	1/2 - 13 X 1	THREADED	70	1-1/2 - 13 X 2-3/4	THREADED
68	1/2 - 13 X 1-1/2		ZZ	HOLLOW KINGPIN	SEE MODULAR STEM CASTER
71	.720 - .851	ROUNDED EXPANDABLE ADAPTER	R1	.720 - .851	SQUARE EXPANDABLE ADAPTER
72	.852 - .927		R2	.852 - .927	
7S	0.920 - 0.980		R3	.928 - 1.029	
73	.928 - 1.029		R4	1.030 - 1.140	
7A	1.020 - 1.100		R5	1.360 - 1.425	
74	1.030 - 1.140		R6	1.426 - 1.589	
75	1.360 - 1.425		R7	1.790 - 1.850	
76	1.426 - 1.589				
77	1.790 - 1.850				
78	1.181 - 1.280				

### MODULAR STEM

Replace \*\* in part # with desired plat or stem code.  
Order modular stems installed with stem code – or uninstalled by part #.

Stem Code	Size	Stem Type	Modular Part #	Stem Code	Size	Stem Type	Modular Part #
91	7/16 X 1-3/8	GRIP RING	07STG91	33	7/16-14 X 1-1/2	THREADED	07STT33
85	1 X 2-3/16	DUAL GRIP RING	07STG85	79	7/16-14 X 2-1/4		07STT79
92	5/8 X 2-3/16	DUAL GRIP RING	07STG92	C4	1/2-13 X 2-3/4		07STTC4
93	13/16 X 2-3/16	DUAL GRIP RING	07STG93	C8	1/2-13 X 3-1/8		07STTC8
95	.846 X 2-3/4	GRIP RING	07STG95	C1	1/2-13 X 4		07STTC1
82	1-1/8" X 2-3/16	DUAL GRIP RING	07STG82	88	3/4-10 X 1		07STTS88
22	1-1/4" X 2-3/16	DUAL GRIP RING	07STG22	87	3/4-10 X 1-3/4		07STT87
23	1-3/8 X 2-3/16	DUAL GRIP RING	07STG23	84	3/4-10 X 4		07STT84
41	0.875 X 2-1/4	OCTAGON GRIP RING	07STO41	C3	3/4-10 X 6		07STTC3
43	9/16 X 2-15/16	SQUARE 2 CROSS HOLES	07STS43	80	5/8-11 X 1		07STT80
51	3/4 X 2	OCTAGON, W/ 3 CROSS DRILL	07STS51	81	5/8-11 X 1-3/4		07STT81
55	7/8 X 2	SQUARE 3 CROSS HOLES 5/16", CROSS SECTION 1.087"	07STS55	C2	5/8-11 X 4		07STTC2
56	7/8 X 2	OCTAGON 3 CROSS HOLES 1/4", CROSS SECTION 0.983"	07STS56	C5	5/8-11 X 2.25		07STTC5
E1	ADJUSTING RANGE 1.75" - 2.375"		07STAE1	F1	ADJUSTING RANGE 1.75" - 2.375"		07STAF1
E2	ADJUSTING RANGE 1.875" - 2.5"		07STAE2	F2	ADJUSTING RANGE 1.875" - 2.5"		07STAF2
E3	ADJUSTING RANGE 3.5" - 4.125"		07STAE3	F3	ADJUSTING RANGE 3.5" - 4.125"		07STAF3
E4	ADJUSTING RANGE 3.5" - 5"		07STAE4	F4	ADJUSTING RANGE 3.5" - 5"	07STAF4	
B1	1.49" X 1-7/8" ADJUSTABLE RANGE 1.78" TO 3" FOR 1.5" TUBING		07STGB1	ZZ	1/2"	HOLLOW KING I. D.	N/A



# DURABLE SUPERIOR CASTERS®

## BEARING OPTIONS

Bearing Code	Description	Wheel Width	Bearing Code	Description	Wheel Width	Bearing Code	Description	Wheel Width
88	PLAIN 3/4" ID	1.5 & 2	49	PRECISION BEARING INTEGRATED W/ TOP HEAD	2	11	SOLID DELRIN BEARING	1.5
03	ROLLER W/ OUTER SPLIT	1.5				12	SOLID DELRIN BEARING	2
04	ROLLER W/ OUTER SPLIT	2	63	PRECISION BALL BEARING	2	57	FLANGED DELRIN BEARING	1.5 & 2
09	CAGED ROLLER BEARINGS	2	60	FLANGED PRECISION BALL BEARING	1.5 & 2	53	FLANGED BALL BEARING	1.5 & 2
48	DUAL-ROLL CAGED BALL BEARING	2	B1	1-PC BRONZE BUSHING	2	B5	FLANGED BRONZE BUSHING	2
73	PRECISION TAPERED BEARING	2	B8	2-PC BRONZE BUSHING	2			

Wheel Diameter	Overall Height*	Swivel Radius	
		79 Series	T9
4"	5-1/8	3-1/4	5-1/4
5"	6-1/8	4	5-1/4
6"	7-1/2	4-5/8	5-1/4
8"	9-1/2	5-7/8	N/A

\*Reduces overall height 1/8" for stem caster

### 79/80/T9 – STAMP-FORMED SERIES – 450 LB

Wheel Diameter	Thread Width	Wheel Type	Load Cap.	Available Bearing Options	+ Color	Replace + with a desired wheel color. Replace ## with desired wheel bearing. Replace ** with desired fastening pattern.		
						79 Series Part #	80 Series Part #	T9 Series Part #
4	1-1/2	YOKE ONLY				79ZZ40HZ82**YY	80ZZ40HZ82**YY	T9ZZ40HZ82**YY
		THERMO-PRO™	280	03, 60		79TP40HI##**YY	80TP40HI##**YY	T9TP40HI##**YY
		POLYOLEFIN	400	03, 60, 90		79PO40HB##**YY	80PO40HB##**YY	T9PO40HB##**YY
		PHENOLIC	450	03, 57, 90		79PH40HB##**YY	80PH40HB##**YY	T9PH40HB##**YY
		HIGH-TEMP PHENOLIC	400	03, 90		79HT40HQ##**YY	80HT40HQ##**YY	T9HT40HQ##**YY
		STEROLLIZER™	350			79BF40HC61**YY	80BF40HC61**YY	T9BF40HC61**YY
		POLYON AL™	450	03, 60, 57	N, R	79SL40HC61**YY	80SL40HC61**YY	T9SL40HC61**YY
		POLY-PRO™	400	03, 60, 57	D, K, U	79PA40H+##**YY	80PA40H+##**YY	T9PA40H+##**YY
		POLYON™	450		G, V	79PP40H+##**YY	80PP40H+##**YY	T9PP40H+##**YY
		BRIMSTONE®	450	03, 90		79PU40H+03**YY	80PU40H+03**YY	T9PU40H+03**YY
		EPOXY	450			79GN40HQ##**YY	80GN40HQ##**YY	T9GN40HQ##**YY
		MAXROK™	450	03, 60, 57		79OV40HQ90**YY	80OV40HQ90**YY	T9OV40HQ90**YY
	2	YOKE ONLY				79MZ40JZ82**YY	80ZZ40JZ82**YY	T9ZZ40JZ82**YY
		ENERGIZER™	450	04, 09, 60		79EN40JB##**YY	80EN40JB##**YY	T9EN40JB##**YY
		NOMADIC™	400	04, 09, 60, 48, 57	I, B	79NM40J+##**YY	80NM40J+##**YY	T9NM40J+##**YY
		RUBBER ON NYLON	400	04, 09, 60, 48, 57		79NR40JB##**YY	80NR40JB##**YY	T9NR40JB##**YY
		RUBBER ON ALUMINUM	400	04, 09, 60, 48, 57		79RA40JB##**YY	80RA40JB##**YY	T9RA40JB##**YY
		THERMO-PRO™	300	04, 09, 60, 63, 48, 57	A, T, Y	79TP40J+##**YY	80TP40J+##**YY	T9TP40J+##**YY
		POLYOLEFIN	450	04, 09, 60, 63, 48, 57	B, E	79PO40J+##**YY	80PO40J+##**YY	T9PO40J+##**YY
		NYLON	450	04, 09, 60, 63, 48, 57		79NY40JE##**YY	80NY40JE##**YY	T9NY40JE##**YY
		ROKHARD™	450	04, 09, 60, 63, 48, 57		79HI40JB##**YY	80HI40JB##**YY	T9HI40JB##**YY
		BRIMSTONE®	450	04, 09, 90		79GN40JQ##**YY	80GN40JQ##**YY	T9GN40JQ##**YY
		EPOXY	450	04, 09, 90		79OV40JQ##**YY	80OV40JQ##**YY	T9OV40JQ##**YY
		MAXROK™	450	04, 09, 60, 63, 48, 57		79MA40JB##**YY	80MA40JB##**YY	T9MA40JB##**YY
		PHENOLIC	450	04, 09, 60, 63, 48, 57		79PH40JB##**YY	80PH40JB##**YY	T9PH40JB##**YY
		HIGH-TEMP PHENOLIC	450	04, 09, 90		79HT40JQ##**YY	80HT40JQ##**YY	T9HT40JQ##**YY
		POLYON MAXROK™	450	04, 09, 60, 63, 48, 57	G, K	79MU40J+##**YY	80MU40J+##**YY	T9MU40J+##**YY
		POLY AL™	450	04, 09, 60, 63, 48, 57	N, R	79PA40J+##**YY	80PA40J+##**YY	T9PA40J+##**YY
POLY-PRO™	450	04, 09, 60, 63, 48, 57	D, K, M, U, W	79PP40J+##**YY	80PP40J+##**YY	T9PP40J+##**YY		
POLYMADIC™	450	04, 09, 60, 63, 48, 57	I, M	79PM40J+##**YY	80PM40J+##**YY	T9PM40J+##**YY		
DURALASTOMER™	450	09, 60, 57		79SU40JL##**YY	80SU40JL##**YY	T9SU40JL##**YY		
ERGONOMIC ELASTOMER	450			79EE40JI60**YY	80EE40JI60**YY	T9EE40JI60**YY		
5	1-1/2	YOKE ONLY				79ZZ50HZ82**YY	80ZZ50HZ82**YY	T9ZZ50HZ82**YY
		THERMO-PRO™	300	03, 60, 57		79TP50HI##**YY	80TP50HI##**YY	T9TP50HI##**YY
		POLYOLEFIN	450	03, 60, 57		79PO50HB##**YY	80PO50HB##**YY	T9PO50HB##**YY
		PHENOLIC	450	03, 60, 57, 90		79PH50HB##**YY	80PH50HB##**YY	T9PH50HB##**YY
		POLYON AL™	450	03, 60, 57	N, R	79PA50H+##**YY	80PA50H+##**YY	T9PA50H+##**YY
		POLY-PRO™	450	03, 60, 57	D, K, S, U	79PP50H+##**YY	80PP50H+##**YY	T9PP50H+##**YY
	2	YOKE ONLY				79ZZ50JZ83**YY	80ZZ50JZ83**YY	T9ZZ50JZ83**YY
		ENERGIZER™	450	04, 09, 60		79EN50JB##**YY	80EN50JB##**YY	T9EN50JB##**YY
		NOMADIC™	450	04, 09, 48, 60, 57	B, I	79NM50J+##**YY	80NM50J+##**YY	T9NM50J+##**YY
		RUBBER ON NYLON	450	04, 09, 48, 60, 57		79NR50JB##**YY	80NR50JB##**YY	T9NR50JB##**YY
		RUBBER ON ALUMINUM	450	04, 09, 48, 60, 57		79RA50JB##**YY	80RA50JB##**YY	T9RA50JB##**YY



79/80/T9 – STAMP-FORMED SERIES – 450 LB

Wheel Diameter	Thread Width	Wheel Type	Load Cap.	Available Bearing Options	+ Color	Replace + with a desired wheel color. Replace ## with desired wheel bearing. Replace ** with desired fastening pattern.			
						79 Series Part #	80 Series Part #	T9 Series Part #	
		CUSHENDURE™	400			79GR50JB19**YY	80GR50JB19**YY	T9GR50JB19**YY	
		THERMO-PRO™	350	04, 09, 60, 48, 63, 57	A, I, T, X, Y, Z	79TP50J+##**YY	80TP50J+##**YY	T9TP50J+##**YY	
		POLYOLEFIN	450		B, E	79P050J+##**YY	80P050J+##**YY	T9P050J+##**YY	
		NYLON	450	04, 09, 60, 48, 53, P3, 57		79NY50JE##**YY	80NY50JE##**YY	T9NY50JE##**YY	
		ROKHARD™	450	04, 09, 48, 60, 57		79HI50JB##**YY	80HI50JB##**YY	T9HI50JB##**YY	
		BRIMSTONE®	450	04, 09, 60, 90		79GN50JQ##**YY	80GN50JQ##**YY	T9GN50JQ##**YY	
		EPOXY	450	04, 09, 90		79OV50JQ##**YY	80OV50JQ##**YY	T9OV50JQ##**YY	
		MAXROK™	450	04, 09, 60, 48, 57		79MA50JB##**YY	80MA50JB##**YY	T9MA50JB##**YY	
		PHENOLIC	450	04, 09, 60, 48, 57, 90		79PH50JB##**YY	80PH50JB##**YY	T9PH50JB##**YY	
		H-TEMP PHENOLIC	450	04, 09, 90		79HT50JQ##**YY	80HT50JQ##**YY	T9HT50JQ##**YY	
		STEROLLIZER™	450			79SL50JCB8**YY	80SL50JCB8**YY	T9SL50JCB8**YY	
		POLYON MAXROK™	450	04, 09, 48, 60, 57	G, K	79MU50J+##**YY	80MU50J+##**YY	T9MU50J+##**YY	
		POLYON AL™	450	04, 09, 48, 60, 57	N, R	79PA50J+##**YY	80PA50J+##**YY	T9PA50J+##**YY	
		POLYON - C	450	04, 09, 48, 60, 57, 12		79PR50JL##**YY	80PR50JL##**YY	T9PR50JL##**YY	
		POLY-PRO™	450	04, 09, 48, 60, 63, 57	B, C, D, K, U, M, W	79PP50J+##**YY	80PP50J+##**YY	T9PP50J+##**YY	
		POLYMADIC™	450	04, 09, 48, 60, 63, 57	I, M	79PM50J+##**YY	80PM50J+##**YY	T9PM50J+##**YY	
		DURALASTOMER™	450	09, 60, 57		79SU50JL##**YY	80SU50JL##**YY	T9SU50JL##**YY	
		ERGONOMIC ELASTOMER	450			79EE60JI60**YY	80EE60JI60**YY	T9EE60JI60**YY	
ERGOLASTOMER™	450	04, 09, 73, 64, 57		79HU50JI##**YY	80HU50JI##**YY	T9HU50JI##**YY			
6	1-1/2	YOKE ONLY				79ZZ60HZ83**YY	80ZZ60HZ83**YY	T9ZZ60HZ83**YY	
		THERMO-PRO™	375	03, 60, 57		79TP60HI##**YY	80TP60HI##**YY	T9TP60HI##**YY	
		POLYOLEFIN	450	03, 60, 90	B, E	79P060H+##**YY	80P060H+##**YY	T9P060H+##**YY	
		PHENOLIC	450	03, 60, 57		79PH60HB##**YY	80PH60HB##**YY	T9PH60HB##**YY	
		POLYON AL™	450	03, 60	N, R	79PA60H+##**YY	80PA60H+##**YY	T9PA60H+##**YY	
		POLY-PRO™	450	03, 60, 57	K, T, U	79PP60H+##**YY	80PP60H+##**YY	T9PP60H+##**YY	
	2	YOKE ONLY				79ZZ60JZ83**YY	80ZZ60JZ83**YY	T9ZZ60JZ83**YY	
		ENERGIZER™	450	04, 09, 60		79EN60JB##**YY	80EN60JB##**YY	T9EN60JB##**YY	
		PNEUMATIC	150			79FP60JB60**YY	80FP60JB60**YY	T9FP60JB60**YY	
		FOAM FILLED	200			79FF60JB60**YY	80FF60JB60**YY	T9FF60JB60**YY	
		EVER-ROLL™	150		B, I	79ER60J+60**YY	80ER60J+60**YY	T9ER60J+60**YY	
		NOMADIC™	450	04, 09, 48, 60, 57		79NM60JB##**YY	80NM60JB##**YY	T9NM60JB##**YY	
		RUBBER ON NYLON	450	04, 09, 48, 60, 57		79NR60JB##**YY	80NR60JB##**YY	T9NR60JB##**YY	
		DURA-CUSHION™	350	04, 09, 63	X, Z	79BC60J+##**YY	80BC60J+##**YY	T9BC60J+##**YY	
		ECO-RUBBER	350	53, P3		79SN60JC##**YY	80SN60JC##**YY	T9SN60JC##**YY	
		RUBBER ON ALUMINUM	450	04, 09, 48, 60, 57		79RA60JB##**YY	80RA60JB##**YY	T9RA60JB##**YY	
		THERMO-PRO™	450	04, 09, 60, 63, 48, 57	A, I, T, X, Y, Z	79TP60J+##**YY	80TP60J+##**YY	T9TP60J+##**YY	
		POLYOLEFIN	450	04, 09, 60, 53, P3, 48, 57	B, E	79P060J+##**YY	80P060J+##**YY	T9P060J+##**YY	
		NYLON	450	04, 09, 48, 60, 57		79NY60JE##**YY	80NY60JE##**YY	T9NY60JE##**YY	
		ROKHARD™	450	04, 09, 48, 60, 57		79HI60JB##**YY	80HI60JB##**YY	T9HI60JB##**YY	
		BRIMSTONE®	450	04, 09, 60, 90		79GN60JQ##**YY	80GN60JQ##**YY	T9GN60JQ##**YY	
		EPOXY	450	04, 09, 90		79OV60JQ##**YY	80OV60JQ##**YY	T9OV60JQ##**YY	
		MAXROK™	450	04, 09, 60, 48, 57		79MA60JB##**YY	80MA60JB##**YY	T9MA60JB##**YY	
		PHENOLIC	450	04, 09, 60, 48, 57		79PH60JB##**YY	80PH60JB##**YY	T9PH60JB##**YY	
		HIGH-TEMP PHENOLIC	450	04, 09, 90		79HT60JQ##**YY	80HT60JQ##**YY	T9HT60JQ##**YY	
		POLY MAXROK™	450	04, 09, 60, 48, 57	G, K	79MU60J+##**YY	80MU60J+##**YY	T9MU60J+##**YY	
		POLYON AL™	450	04, 09, 48, 60, 57	N, R	79PA60J+##**YY	80PA60J+##**YY	T9PA60J+##**YY	
		POLYON-C	450	04, 09, 48, 60, 57, 12		79PR60JL##**YY	80PR60JL##**YY	T9PR60JL##**YY	
		POLY-PRO™	450	04, 09, 48, 60, 57	D, I, K, M, W, U	79PP60J+##**YY	80PP60J+##**YY	T9PP60J+##**YY	
		POLYMADIC™	450	04, 09, 48, 60, 63, 57	I, M	79PM60J+##**YY	80PM60J+##**YY	T9PM60J+##**YY	
	CHAMPION	450			79CP60JN64**YY	80CP60JN64**YY	T9CP60JN64**YY		
	DURALASTOMER™	450	09, 60, 57		79SU60JL##**YY	80SU60JL##**YY	T9SU60JL##**YY		
	ERGONOMIC ELASTOMER	450			79EE60JI60**YY	80EE60JI60**YY	T9EE60JI60**YY		
	ERGOLASTOMER™	450	04, 09, 73, 64, 57		79HU60JI##**YY	80HU60JI##**YY	T9HU60JI##**YY		
	8	1-1/2	YOKE ONLY				79ZZ80HZ83**YY	80ZZ80HZ83**YY	
			THERMO-PRO™	400		I, T	79TP80H+53**YY	80TP80H+53**YY	
POLY-PRO™			400			79PP80HT53**YY	80PP80HT53**YY		
RUBBER ON ALUMINUM			400			79RA80PB53**YY	80RA80PB53**YY		



# DURABLE SUPERIOR CASTERS®

## H9/H0 – STAMP-FORMED SERIES – 660 LB

**NEW****H9****H0**

- 5/32" thick steel deeply embossed for best strength
- Dual ball raceways
- Zinc-plated
- 1/2" axle

FASTENING PATTERN			
Pate Code	Top Plate	Bolt Hole Pattern	Mounting Bolt
17	4X4-1/2	2-5/8 X 3-5/8 TO 3X3	3/8

WHEEL DIAMETER, OVERALL HEIGHT AND SWIVEL RADIUS		
Wheel Diameter	Overall Height	Swivel Radius
4	5-5/16	3-1/2
5	6-5/16	4
6	7-5/16	4-5/7

### H9/H0 – STAMP-FORMED SERIES – 660 LB

Wheel Diameter	Thread Width	Wheel Type	Load Capacity	Available Bearing Options	+ Color	Replace + with a desired wheel color. Replace ## with desired wheel bearing.		
						H9 Series Swivel Part #	H0 Series Rigid Part #	
4	2	YOKE ONLY					H9ZZ40JZ8317YY	H0ZZ40JZ8317YY
		ENERGIZER™	500	04, 09, 60			H9EN40JB##17YY	H0EN40JB##17YY
		NOMADIC™	400	04, 09, 60, 48, 57	I, B		H9NM40J+##17YY	H0NM40J+##17YY
		RUBBER ON NYLON	400	04, 09, 60, 48, 57			H9NR40JB##17YY	H0NR40JB##17YY
		RUBBER ON ALUMINIUM	400	04, 09, 60, 48, 57			H9RA40JB##17YY	H0RA40JB##17YY
		LOW PROFILE RUBBER	300				H9LP40JB0417YY	H0LP40JB0417YY
		MOLD-ON RUBBER	400	04, 09, 60, 48, 57			H9RS40JB##17YY	H0RS40JB##17YY
		THERMO-PRO™	300	04, 09, 60, 63, 48, 57	A, T, Y		H9TP40J+##17YY	H0TP40J+##17YY
		POLYOLEFIN	500	04, 09, 60, 63, 48, 57	B, E		H9PO40J+##17YY	H0PO40J+##17YY
		NYLON	660	04, 09, 60, 63, 48, 57			H9NY40JE##17YY	H0NY40JE##17YY
		IRONMAN	660	04, 09			H9NX40JB##17YY	H0NX40JB##17YY
		ROKHARD™	660	04, 09, 60, 63, 48, 57			H9HI40JB##17YY	H0HI40JB##17YY
		BRIMSTONE®	660	04, 09, 90			H9GN40JQ##17YY	H0GN40JQ##17YY
		EPOXY	660	04, 09, 90			H9OV40JQ##17YY	H0OV40JQ##17YY
		MAXROK™	660	04, 09, 60, 73			H9MA40JB##17YY	H0MA40JB##17YY
		PHENOLIC	660	04, 09, 60, 63, 48, 57			H9PH40JB##17YY	H0PH40JB##17YY
		PHENOLIC (STRAIGHT SIDED)	660	04, 09, 60, 57, 12			H9PH40TB##17YY	H0PH40TB##17YY
		HIGH-TEMP PHENOLIC	600	04, 09, 90			H9HT40JQ##17YY	H0HT40JQ##17YY
		POLYON MAXROK™	660	04, 09, 60, 63, 48, 57	G, K		H9MU40J+##17YY	H0MU40J+##17YY
		POLYON-AL™	660	04, 09, 60, 63, 48, 57	N, R		H9PA40J+##17YY	H0PA40J+##17YY
		DW-BLACK	660				H9DW40JLT317YY	H0DW40JLT317YY
		DW-RED	660				H9DW40JRT317YY	H0DW40JRT317YY
		DW-BLUE	660				H9DW40JBT317YY	H0DW40JBT317YY
		DW-GRAY	660				H9DW40JGT317YY	H0DW40JGT317YY
		POLY-PRO™	450	04, 09, 60, 63, 48, 57	D, K, M, U, W		H9PP40J+##17YY	H0PP40J+##17YY
		POLYADIC™	600	04, 09, 60, 63, 48, 57	I, M		H9PM40J+##17YY	H0PM40J+##17YY
		POLYON™	660	04, 09, 60	G, V		H9PU40J+##17YY	H0PU40J+##17YY
							H9PU40JV6317YY	H0PU40JV6317YY
		ENERGY SAVER POLYON™	600	04, 09, 60, 73			H9SV40JU##17YY	H0SV40JU##17YY
		POLYFLEXON™ CAST	660	04, 09, 60, 63, 48, 57			H9RP40JK##17YY	H0RP40JK##17YY
		POLYFLEXON™	660			N, O	H9UA40J+6417YY	H0UA40J+6417YY
		D-POLYON	660				H9UD40JL6417YY	H0UD40JL6417YY
		DURALASTOMER™	660	09, 60, 57			H9SU40JL##17YY	H0SU40JL##17YY
		SX ELASTOMER	660	04, 09, 60			H9SX40JI##17YY	H0SX40JI##17YY
ERGOLASTOMER™	660	04, 09, 73, 64, 57			H9HU40JI##17YY	H0HU40JI##17YY		
SEMI-STEEL	660	04, 09			H9SS40JS##17YY	H0SS40JS##17YY		
HEAVY DUTY IRON	660	04, 09, 63			H9HS40JS##17YY	H0HS40JS##17YY		
DUCTILE	660	04, 09, 63, 73			H9DS40JR##17YY	H0DS40JR##17YY		
SOLID STEEL	660	09, B1, B5			H9MS40JS##17YY	H0MS40JS##17YY		
ENERGY SAVER DUCTILE™	660	04, 09, B1, B5			H9CD40JR##17YY	H0CD40JR##17YY		
MAXROK™	660	04, 09, 60, 57			H9MV40JT##17YY	H0MV40JT##17YY		
IRON V-GROOVE	600	04, 09			H9VG40JT##17YY	H0VG40JT##17YY		
DUCTILE V-GROOVE	660	04, 09, B1, B5			H9DV40JT##17YY	H0DV40JT##17YY		
5	2	YOKE ONLY					H9ZZ50JZ8317YY	H0ZZ50JZ8317YY
		ENERGIZER™	550	04, 09, 60			H9EN50JB##17YY	H0EN50JB##17YY
		NOMADIC™	500	04, 09, 48, 60, 57	B, I		H9NM50J+##17YY	H0NM50J+##17YY
		RUBBER ON NYLON	450	04, 09, 48, 60, 57			H9NR50JB##17YY	H0NR50JB##17YY
		RUBBER ON ALUMINIUM	500	04, 09, 48, 60, 57			H9RA50JB##17YY	H0RA50JB##17YY
		MOLD-ON RUBBER	400	04, 09, 60, 48, 57			H9RS50JB##17YY	H0RS50JB##17YY
		CUSHENDURE™	400				H9GR50JB1917YY	H0GR50JB1917YY
		THERMO-PRO™	300	04, 09, 60, 48, 63, 57	A, I, T, X, Y, Z		H9TP50J+##17YY	H0TP50J+##17YY



H9/H0 – STAMP-FORMED SERIES – 660 LB

Wheel Diameter	Thread Width	Wheel Type	Load Capacity	Available Bearing Options	+ Color	Replace + with a desired wheel color. Replace ## with desired wheel bearing.	
						H9 Series Swivel Part #	H0 Series Rigid Part #
5	2	POLYOLEFIN	500		B, E	H9P050J+##17YY	H0P050J+##17YY
		NYLON	660	04, 09, 60, 48, 53, P3, 57		H9N950JE##17YY	H0N950JE##17YY
		IRONMAN	660	64, 70		H9NX50JB##17YY	H0NX50JB##17YY
		ROKHARD™	660	04, 09, 48, 60, 57		H9HI50JB##17YY	H0HI50JB##17YY
		BRIMSTONE®	660	04, 09, 60, 90		H9GN50JQ##17YY	H0GN50JQ##17YY
		EPOXY	660	04, 09, 90		H9OV50JQ##17YY	H0OV50JQ##17YY
		MAXROK™	660	04, 09, 60, 48, 57		H9MA50JB##17YY	H0MA50JB##17YY
		PHENOLIC	660	04, 09, 60, 48, 57, 90		H9PH50JB##17YY	H0PH50JB##17YY
		H-TEMP PHENOLIC	660	04, 09, 90		H9HT50JQ##17YY	H0HT50JQ##17YY
		STEROLLIZER™	600			H9SL50JCB817YY	H0SL50JCB817YY
		POLYON MAXROK™	660	04, 09, 48, 60, 57		H9MU50J+##17YY	H0MU50J+##17YY
		POLYON AL™	660	04, 09, 48, 60, 57	G, K	H9PA50J+##17YY	H0PA50J+##17YY
		POLYON - C	660	04, 09, 48, 60, 57, 12	N, R	H9PR50JL##17YY	H0PR50JL##17YY
		DW-BLACK	660			H9DW50JLT317YY	H0DW50JLT317YY
		DW-RED	660			H9DW50JRT317YY	H0DW50JRT317YY
		DW-BLUE	660			H9DW50JBT317YY	H0DW50JBT317YY
		DW-GRAY	450			H9DW50JGT317YY	H0DW50JGT317YY
			600	04, 09, 48, 60, 63, 57	B, C, D, K, U, M, W	H9PP50J+##17YY	H0PP50J+##17YY
		POLY-PRO™	660			H9PP50JP6317YY	H0PP50JP6317YY
						H9PP50JH6317YY	H0PP50JH6317YY
		POLYMADIC™	600	04, 09, 48, 60, 63, 57	I, M	H9PM50J+##17YY	H0PM50J+##17YY
		POLYON™	660			H9PU50JV6317YY	H0PU50JV6317YY
			660	04, 09, 60, 48	G, V	H9PU50J+##17YY	H0PU50J+##17YY
		ENERGY SAVER POLYON™	660	04, 09, 60, 48		H9SW50JU##17YY	H0SW50JU##17YY
		POLYFLEXON™ CAST	660	04, 09, 60, 48		H9RP50JK##17YY	H0RP50JK##17YY
		POLYFLEXON™	660		N, O	H9UA50J+6417YY	H0UA50J+6417YY
		D-POLYON	660			H9UD50JL6417YY	H0UD50JL6417YY
		DURALASTOMER™	660	09, 60, 57		H9SU50JL##17YY	H0SU50JL##17YY
		SX ELASTOMER	660	04, 09, 60		H9SX60JI##17YY	H0SX60JI##17YY
		ERGOLASTOMER™	660	04, 09, 73, 64, 57		H9HU50JI##17YY	H0HU50JI##17YY
		SEMI-STEEL	660	04, 09		H9SS50JS##17YY	H0SS50JS##17YY
		HEAVY DUTY IRON	660	04, 09, 63		H9HS50JS##17YY	H0HS50JS##17YY
		DUCTILE	660	04, 09, 73, 63, B1, B5		H9DS50JR##17YY	H0DS50JR##17YY
		FORGED STEEL	600	02, 09, B5, B1		H9FS50JS##17YY	H0FS50JS##17YY
		ENERGY SAVER DUCTILE™	660	04, 09, B1, B5		H9CD50JR##17YY	H0CD50JR##17YY
IRON V-GROOVE	550	04, 09		H9VG50JT##17YY	H0VG50JT##17YY		
		YOKE ONLY		H9ZZ60JZ8317YY	H0ZZ60JZ8317YY		
ENERGIZER™	600	04, 09, 60		H9EN60JB##17YY	H0EN60JB##17YY		
PNEUMATIC	250			H9FP60JB6017YY	H0FP60JB6017YY		
FOAM FILLED	250			H9FF60JB6017YY	H0FF60JB6017YY		
EVER-ROLL™	250		B, I	H9ER60J+6017YY	H0ER60J+6017YY		
NOMADIC™	600	04, 09, 48, 60, 57		H9NM60JB##17YY	H0NM60JB##17YY		
RUBBER ON NYLON	550	04, 09, 48, 60, 57		H9NR60JB##17YY	H0NR60JB##17YY		
DURA-CUSHION™	350	04, 09, 63	X, Z	H9BC60J+##17YY	H0BC60J+##17YY		
ECO-RUBBER	350	53, P3		H9SN60JC##17YY	H0SN60JC##17YY		
RUBBER ON ALUMINUM	550	04, 09, 48, 60, 57		H9RA60JB##17YY	H0RA60JB##17YY		
LOW PROFILE RUBBER	600			H9LP60JB0417YY	H0LP60JB0417YY		
MOLD-ON RUBBER	550	04, 09, 48, 60, 57		H9RS60JB###17Y	H0RS60JB###17Y		
SUPREME RUBBER	660	63, 73		H9RH60JS##17YY	H0RH60JS##17YY		
THERMO-PRO™	500	04, 09, 60, 63, 48, 57	A, I, T, X, Y, Z	H9TP60J+##17YY	H0TP60J+##17YY		
POLYOLEFIN	660	04, 09, 60, 53, P3, 48, 57	B, E	H9P060J+##17YY	H0P060J+##17YY		
NYLON	660	04, 09, 48, 60, 57		H9NY60JE##17YY	H0NY60JE##17YY		
IRONMAN	660			H9NX60JB6417YY	H0NX60JB6417YY		
ROKHARD™	660	04, 09, 48, 60, 57		H9HI60JB##17YY	H0HI60JB##17YY		
BRIMSTONE®	660	04, 09, 60, 90		H9GN60JQ##17YY	H0GN60JQ##17YY		
EPOXY	660	04, 09, 90		H9OV60JQ##17YY	H0OV60JQ##17YY		
MAXROK™	660	04, 09, 60, 48, 57		H9MA60JB##17YY	H0MA60JB##17YY		
PHENOLIC	660	04, 09, 60, 48, 57		H9PH60JB##17YY	H0PH60JB##17YY		
				H9PH60TB##17YY	H0PH60TB##17YY		
HIGH-TEMP PHENOLIC	660	04, 09, 90		H9HT60JQ##17YY	H0HT60JQ##17YY		
POLY MAXROK™	660	04, 09, 60, 48, 57	G, K	H9MU60J+##17YY	H0MU60J+##17YY		
POLYON AL™	660	04, 09, 48, 60, 57	N, R	H9PA60J+##17YY	H0PA60J+##17YY		
POLYON - C	660	04, 09, 48, 60, 57, 12		H9PR60JL##17YY	H0PR60JL##17YY		
DW-BLACK	660			H9DW60JLT317YY	H0DW60JLT317YY		
DW-RED	660			H9DW60JRT317YY	H0DW60JRT317YY		
DW-BLUE	660			H9DW60JBT317YY	H0DW60JBT317YY		
DW-GRAY	660			H9DW60JGT317YY	H0DW60JGT317YY		
		04, 09, 48, 60, 57	D, I, K, M, W, U	H9PP60J+##17YY	H0PP60J+##17YY		
POLY-PRO™	660			H9PP60JP6317YY	H0PP60JP6317YY		
				H9PP60JH6317YY	H0PP60JH6317YY		
POLYMADIC™	660	04, 09, 48, 60, 63, 57	I, M	H9PM60J+##17YY	H0PM60J+##17YY		



# DURABLE SUPERIOR CASTERS®

H9/H0 – STAMP-FORMED SERIES – 660 LB

Wheel Diameter	Thread Width	Wheel Type	Load Capacity	Available Bearing Options	+ Color	Replace + with a desired wheel color. Replace ## with desired wheel bearing.	
						H9 Series Swivel Part #	H0 Series Rigid Part #
6	2	POLYON™	660	04, 09, 60	G, V	H9PU60JV6317YY	H0PU60JV6317YY
		ENERGY SAVER POLYON™	660	04, 09, 63, 73		H9PU60J+##17YY	H0PU60J+##17YY
		POLYFLEXON™ CAST	660	04, 09, 60, 48, 57		H9SW60JU##17YY	H0SW60JU##17YY
		POLYFLEXON™	660		N, O	H9RP60JK##17YY	H0RP60JK##17YY
		D-POLYON	660			H9UA60J+6417YY	H0UA60J+6417YY
		CHAMPION	660			H9UD60JL6417YY	H0UD60JL6417YY
		DURALASTOMER™	660	09, 60, 57		H9CP60JN6417YY	H0CP60JN6417YY
		SX ELASTOMER	660	04, 09, 60		H9SU60JL##17YY	H0SU60JL##17YY
		ERGOLASTOMER™	660	04, 09, 73, 64, 57		H9SX60JL##17YY	H0SX60JL##17YY
		SEMI-STEEL	660	04, 09		H9HU60JL##17YY	H0HU60JL##17YY
		HEAVY DUTY IRON	660	04, 09, 63		H9SS60JS##17YY	H0SS60JS##17YY
		DUCTILE	660	04, 09, 73, 63, B1, B5		H9HS60JS##17YY	H0HS60JS##17YY
		ENERGY SAVER DUCTILE™	660	04, 09, B1, B5		H9DS60JR##17YY	H0DS60JR##17YY
		FORGED STEEL	660	04, 09, 73, 63, B1, B5		H9CD60JR##17YY	H0CD60JR##17YY
		IRON V-GROOVE	660	04, 09		H9FS60JS##17YY	H0FS60JS##17YY
		DUCTILE V-GROOVE	660	04, 09, B1, B5		H9VG60JT##17YY	H0VG60JT##17YY
							H9DV60JT##17YY

WHEEL TYPE OPTIONS									
Ever-Roll™ Tires ??	Champion™	Ever-Roll™ Tires	Polyflexon™	Poly-Pro™	D-Polyon™	Ironman™	Phenolic	High-Temp Phenolic	Epoxy
Semi-Steel	Cast Iron V-Groove	Heavy-Duty Semi-Steel	Drop Forged Steel	Cast Iron Mold-On Rubber	Semi-Pneumatic Tires	Super Elastomer	Poly-Al™	Polyon™	Polyflexon™

Our highly trained and experienced customer service and sales staff can help assist you in choosing the appropriate caster or wheel for your application.



**27/28/39/DT/FT – MEDIUM DUTY SERIES (OEM PREFERRED SERIES) – 1,250 LB**



**27 Series Swivel Caster Shown With Optional Top Lock Brake and Raceway Seals**



**28 Series Rigid Caster**

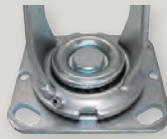

**39 Series**



**DT Series Dual Pedal Total-Lock Caster**

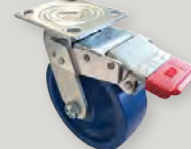

**FT Series Total-Lock Caster**



**Underside of Brake Pad**

- Double ball raceway with 5/8" kingbolt
- Features wheels with 1-1/2" and 2" tread widths
- Large selections of wheels, bearings and brake options
- Matching total-locking casters available DT and FT series
- Grease fitting in raceway and axle for maintenance
- Bright zinc finish
- Majority of this series and wheel types are NSF listed

BRAKE OPTIONS					OTHER OPTIONS			
Tech-Lock Pedal Brake (H)	Top Lock Brake (T)	A-Cam Brake (A)	Cam-Lock Brake (C)	Side-Lock Brake (S)	Face Contact Brake	4-Position Lock (P)	Thread Guards (G)	Toe Guard 4Y

BEARING OPTIONS								
Bearing Code	Description	Wheel Width	Bearing Code	Description	Wheel Width	Bearing Code	Description	Wheel width
88	PLAIN 3/4" ID	1.5 & 2	49	PRECISION BEARING INTEGRATED W/ TOP HEAD	2	11	SOLID DELRIN BEARING	1.5
03	ROLLER W/ OUTER SPLIT	1.5				12	SOLID DELRIN BEARING	2
04	ROLLER W/ OUTER SPLIT	2	63	PRECISION BALL BEARING	2	57	FLANGED DELRIN BEARING	1.5 & 2
09	CAGED ROLLER BEARINGS	2	60	FLANGED PRECISION BALL BEARING	1.5 & 2	53	FLANGED BALL BEARING	1.5 & 2
48	DUAL-ROLL CAGED BALL BEARING	2	B1	1-PC BRONZE BUSHING	2	B5	FLANGED BRONZE BUSHING	2
73	PRECISION TAPERED BEARING	2						

FASTENING PATTERNS			
Plate Code	Overall Size	Bolt Hole Pattern	Mounting Bolt Size
17	4X4-15/32	2-5/8X3-5/8 TO 3X3	3/8
A7	3-53/64 X 4-13/32	2-5/8X3-5/8 TO 3X3 (WITH TWO 5/16" HOLES CENTERED AT 3.935 BETWEEN LONG-WAY HOLES FOR USE ON ALUMINUM STRUCTURAL FRAMING)	
AVAILABLE IN 40, 50, 60 AND 80			
20	5 X 5-1/2		
P1	5-5/16 X 6-11/16	4-1/8 X 5-1/2	
Stem Code	Size	Threaded Portion	
T1	3/4-10X2-1/4	FULL LENGTH	
84	3/4-10X4		
37	3/4-10X5.5	2" FROM THE TOP	
C7	1-8X4	FULL LENGTH	

WHEEL DIAMETER, OVERALL HEIGHT AND SWIVEL RADIUS					
Wheel Diameter	Overall Height	Denotation Code	27 Series Swivel Radius	DT Series Swivel Radius	FT Series Swivel Radius
3-1/4	4-1/4 STANDARD	34	3-1/4	NA	NA
4	5-5/8 STANDARD	40	3-1/4	5	6-1/4
	6-1/2 STANDARD	50	4	5	6-1/4
5	6-1/8 OPTIONAL HEIGHT	54	3-3/4	NA	NA
	7-1/2 STANDARD	60	4-9/16	5	6-1/4
6	7-1/4 OPTIONAL	61	4-1/2	NA	NA
	8	67	5	NA	NA
8	9-1/2 STANDARD	80	6	6	7-1/4
	10-1/8 OPTIONAL HEIGHT	81	6-1/2	NA	NA
10	11-3/4	10	7	NA	NA



# DURABLE SUPERIOR CASTERS®

27/28/39/DT/FT – MEDIUM DUTY SERIES (OEM PREFERRED SERIES) – 1,250 LB

Wheel Dia.	Thread Width	Wheel Type	Load Cap.	Available Bearing Options	+ Color	Replace + with a desired wheel color. Replace ## with desired wheel bearing. Replace * with desired fastening pattern.				
						27 Series Part #	39 Series Part #	28 Series Part #	DT Series Part #	FT Series Part #
3-1/4	1-1/2	YOKE ONLY				27ZZ34HZ83A7YY		28ZZ34HZ83A7YY		
		POLYON™	500			27PU34HG03A7YY		28PU34HG03A7YY		
		HIGH-TEMP PHENOLIC	400	03, 90		27HT34HQ##A7YY		28HT34HQ##A7YY		
		PHENOLIC	600	03, 90		27PH34HB##A7YY		28PH34HB##A7YY		
		SEMI-STEEL	400			27SS34HS03A7YY		28SS34HS03A7YY		
	2	YOKE ONLY				27ZZ34JZ83A7YY		28ZZ34JZ83A7YY		
		POLYON™	600	04, 09, 60		27PU34JG##A7YY		28PU34JG##A7YY		
		MAXROK™	900	04, 09, 60, 57		27MA34JB##A7YY		28MA34JB##A7YY		
		PHENOLIC	700	04, 09, 60, 57		27PH34JB##A7YY		28PH34JB##A7YY		
		SEMI-STEEL	700	04, 09, 60		27SS34JS##A7YY		28SS34JS##A7YY		
1-1/2	YOKE ONLY				27ZZ40HZ83A7YY		28ZZ40HZ83A7YY			
	MOLD-ON RUBBER	350	03, 60, 57		27RS40HB##A7YY		28RS40HB##A7YY			
	THERMO-PRO™	281	03, 60		27TP40HI##A7YY		28TP40HI##A7YY			
	POLYOLEFIN	400	03, 60, 90		27PO40HB##A7YY		28PO40HB##A7YY			
	PHENOLIC	600	03, 57, 90		27PH40HB##A7YY		28PH40HB##A7YY			
	HIGH-TEMP PHENOLIC	400	03, 90		27HT40HQ##A7YY		28HT40HQ##A7YY			
	STEROLLIZER™	350				27BF40HC61A7YY		28BF40HC61A7YY		
						27SL40HC61A7YY		28SL40HC61A7YY		
	POLYON AL™	700	03, 60, 57	N, R	27PA40H+##A7YY		28PA40H+##A7YY			
	POLY-PRO™	400	03, 60, 57	D, K, U	27PP40H+##A7YY		28PP40H+##A7YY			
	POLYON™	600		G, V	27PU40H+03A7YY		28PU40H+03A7YY			
	ENERGY SAVER POLYON™	600			27SW40HU03A7YY		28SW40HU03A7YY			
	BRIMSTONE®	700	03, 90		27GN40HQ##A7YY		28GN40HQ##A7YY			
	EPOXY	700			27OV40HQ90A7YY		28OV40HQ90A7YY			
	SEMI-STEEL	600			27SS40HS03A7YY		28SS40HS03A7YY			
	DUCTILE	1200			27DS40HR08A7YY		28DS40HR08A7YY			
	MAXROK™ V-GROOVE	600	03, 60, 57		27MV40HT##A7YY		28MV40HT##A7YY			
	IRON V-GROOVE	350			27VG40HT03A7YY		28VG40HT03A7YY			
	1-13/16	SOLID STEEL V-GROOVE				27SV40IT14A7YY		28SV40IT14A7YY		
		YOKE ONLY				27ZZ40JZ83**YY	39ZZ40JZ83A7YY	28ZZ40JZ83**YY	DTZZ40JZ8317YY	FTZZ40JZ8317YY
4	NEO-ENERGIZER™	500	04, 09, 60		27EN40JB##**YY	39EN40JB##A7YY	28EN40JB##**YY	DTEN40JB##17YY	FTEN40JB##17YY	
	NOMADIC™	400	04, 09, 60, 48, 57	I, B	27NM40J+###**YY	39NM40J+##A7YY	28NM40J+###**YY	DTNM40J+##17YY	FTNM40J+##17YY	
	RUBBER ON NYLON	400	04, 09, 60, 48, 57		27NR40JB##**YY	39NR40JB##A7YY	28NR40JB##**YY	DTNR40JB##17YY	FTNR40JB##17YY	
	RUBBER ON ALUMINUM	400	04, 09, 60, 48, 57		27RA40JB##**YY	39RA40JB##A7YY	28RA40JB##**YY	DTRA40JB##17YY	FTRA40JB##17YY	
	LOW PROFILE RUBBER	300			27LP40JB04**YY	39LP40JB04A7YY	28LP40JB04**YY	DTLP40JB0417YY	FTLP40JB0417YY	
	MOLD-ON RUBBER	400	04, 09, 60, 48, 57		27RS40JB##**YY	39RS40JB##A7YY	28RS40JB##**YY	DTRS40JB##17YY	FTRS40JB##17YY	
	THERMO-PRO™	300	04, 09, 60, 63, 48, 57	A, T, Y	27TP40J+##**YY	39TP40J+##A7YY	28TP40J+##**YY	DTTP40J+##17YY	FTTP40J+##17YY	
	POLYOLEFIN	500	04, 09, 60, 63, 48, 57	B, E	27PO40J+##**YY	39PO40J+##A7YY	28PO40J+##**YY	DTPO40J+##17YY	FTPO40J+##17YY	
	NYLON	810	04, 09, 60, 63, 48, 57		27NY40JE##**YY	39NY40JE##A7YY	28NY40JE##**YY	DTNY40JE##17YY	FTNY40JE##17YY	
	IRONMAN	1250	40, 09, 65, 73		27NX40JB##**YY	39NX40JB##A7YY	28NX40JB##**YY	DTNX40JB##17YY	FTNX40JB##17YY	
	ROKHARD™	800	04, 09, 60, 63, 48, 57		27HI40JB##**YY	39HI40JB##A7YY	28HI40JB##**YY	DTHI40JB##17YY	FTHI40JB##17YY	
	BRIMSTONE®	800	04, 09, 90		27GN40JQ##**YY	39GN40JQ##A7YY	28GN40JQ##**YY	DTGN40JQ##17YY	FTGN40JQ##17YY	
	EPOXY	800	04, 09, 90		27OV40JQ##**YY	39OV40JQ##A7YY	28OV40JQ##**YY	DTOV40JQ##17YY	FTOV40JQ##17YY	
	MAXROK™	800	04, 09, 60, 63, 48, 57		27MA40JB##**YY	39MA40JB##A7YY	28MA40JB##**YY	DTMA40JB##17YY	FTMA40JB##17YY	
	PHENOLIC	800	04, 09, 60, 63, 48, 57		27PH40JB##**YY	39PH40JB##A7YY	28PH40JB##**YY	DTPH40JB##17YY	FTPH40JB##17YY	
	PHENOLIC (STRAIGHT SIDED)	1000	04, 09, 60, 57, 12		27PH40TB##**YY	39PH40TB##A7YY	28PH40TB##**YY	DTPH40TB##17YY	FTPH40TB##17YY	
	HIGH-TEMP PHENOLIC	600	04, 09, 90		27HT40JQ##**YY	39HT40JQ##A7YY	28HT40JQ##**YY	DTHT40JQ##17YY	FTHT40JQ##17YY	
	POLYON MAXROK™	700	04, 09, 60, 63, 48, 57	G, K	27MU40J+##**YY	39MU40J+##A7YY	28MU40J+##**YY	DTMU40J+##17YY	FTMU40J+##17YY	
	POLYON AL™	800	04, 09, 60, 63, 48, 57	N, R	27PA40J+##**YY	39PA40J+##A7YY	28PA40J+##**YY	DTPA40J+##17YY	FTPA40J+##17YY	



27/28/39/DT/FT – MEDIUM DUTY SERIES (OEM PREFERRED SERIES) – 1,250 LB

Wheel Dia.	Thread Width	Wheel Type	Load Cap.	Available Bearing Options	+ Color	Replace + with a desired wheel color. Replace ## with desired wheel bearing. Replace ** with desired fastening pattern.					
						27 Series Part #	39 Series Part #	28 Series Part #	DT Series Part #	FT Series Part #	
		DW - BLACK	470			27DW40JLT3**YY	39DW40JLT3A7YY	28DW40JLT3**YY	DTDW40JLT317YY	FTDW40JLT317YY	
		DW - RED	540			27DW40JRT3**YY	39DW40JRT3A7YY	28DW40JRT3**YY	DTDW40JRT317YY	FTDW40JRT317YY	
		DW - BLUE	960			27DW40JBT3**YY	39DW40JBT3A7YY	28DW40JBT3**YY	DTDW40JBT317YY	FTDW40JBT317YY	
		DW - GRAY	1000			27DW40JGT3**YY	39DW40JGT3A7YY	28DW40JGT3**YY	DTDW40JGT317YY	FTDW40JGT317YY	
		POLY-PRO™	500	04, 09, 60, 63, 48, 57	D, K, M, U, W		27PP40J+##**YY	39PP40J+##A7YY	28PP40J+##**YY	DTPP40J+##17YY	FTPP40J+##17YY
			600				27PP40JP49**YY	39PP40JP49**YY	28PP40JP49**YY	DTPP40JP49**YY	FTPP40JP49**YY
		POLYMADIC™	600	04, 09, 60, 63, 48, 57	I, M		27PM40J+##**YY	39PM40J+##A7YY	28PM40J+##**YY	DTPM40J+##17YY	FTPM40J+##17YY
			800	04, 09, 60	G, V		27PU40J+##**YY	39PU40J+##A7YY	28PU40J+##**YY	DTPU40J+##17YY	FTPU40J+##17YY
		POLYON™	800				27PU40JV63**YY	39PU40JV63A7YY	28PU40JV63**YY	DTPU40JV6317YY	FTPU40JV6317YY
			800				27SW40JU##**YY	39SW40JU##A7YY	28SW40JU##**YY	DTSW40JU##17YY	FTSW40JU##17YY
		ENERGY SAVER POLYON™	800	04, 09, 60, 73			27SW40JU##**YY	39SW40JU##A7YY	28SW40JU##**YY	DTSW40JU##17YY	FTSW40JU##17YY
		POLYFLEXON™ CAST	700	04, 09, 60, 63, 48, 57			27RP40JK##**YY	39RP40JK##A7YY	28RP40JK##**YY	DTRP40JK##17YY	FTRP40JK##17YY
		POLYFLEXON™	900			N, O	27UA40J+64**YY	39UA40J+64A7YY	28UA40J+64**YY	DTUA40J+6417YY	FTUA40J+6417YY
		D-POLYON	900				27UD40JL64**YY	39UD40JL64A7YY	28UD40JL64**YY	DTUD40JL6417YY	FTUD40JL6417YY
		ULTRAFLEX™	900	64			27UX40J064**YY	39UX40J064A7YY	28UX40J064**YY	DTUX40J06417YY	FTUX40J06417YY
		DURALASTOMER™	750	09, 60, 57			27SU40JL##**YY	39SU40JL##A7YY	28SU40JL##**YY	DTSU40JL##17YY	FTSU40JL##17YY
		SUPER ELASTOMER	1200				27EE40JI60**YY	39EE40JI60A7YY	28EE40JI60**YY	DTEE40JI6017YY	FTEE40JI6017YY
		ERGOLASTOMER™	1000	04, 09, 73, 64, 57			27HU40JI##**YY	39HU40JI##A7YY	28HU40JI##**YY	DTHU40JI##17YY	FTHU40JI##17YY
		SEMI-STEEL	700	04, 09			27SS40JS##**YY	39SS40JS##A7YY	28SS40JS##**YY	DTSS40JS##17YY	FTSS40JS##17YY
		HEAVY DUTY IRON	900	04, 09, 63			27HS40JS##**YY	39HS40JS##A7YY	28HS40JS##**YY	DTHS40JS##17YY	FTHS40JS##17YY
		DUCTILE	1250	04, 09, 63, 73			27DS40JR##**YY	39DS40JR##A7YY	28DS40JR##**YY	DTDS40JR##17YY	FTDS40JR##17YY
		SOLID STEEL	1250	09, B1, B5			27MS40JS##**YY	39MS40JS##A7YY	28MS40JS##**YY	DTMS40JS##17YY	FTMS40JS##17YY
		ENERGY SAVER DUCTILE™	1250	04, 09, B1, B5			27CD40JR##**YY	39CD40JR##A7YY	28CD40JR##**YY	DTCD40JR##17YY	FTCD40JR##17YY
		MAXROK™ V-GROOVE	800	04, 09, 60, 57			27MV40JT##**YY	39MV40JT##A7YY	28MV40JT##**YY	DTMV40JT##17YY	FTMV40JT##17YY
IRON V-GROOVE	600	04, 09			27VG40JT##**YY	39VG40JT##A7YY	28VG40JT##**YY	DTVG40JT##17YY	FTVG40JT##17YY		
DUCTILE V-GROVE	1250	04, 09, B1, B5			27DV40JT##**YY	39DV40JT##A7YY	28DV40JT##**YY	DTDV40JT##17YY	FTDV40JT##17YY		
1-1/2		YOKE ONLY				27ZZ50HZ82A7YY		28ZZ50HZ82A7YY			
		MOLD-ON RUBBER	350	03, 60, 57		27RS50HB##A7YY		28RS50HB##A7YY			
		THERMO-PRO™	300	03, 60, 57		27TP50H##A7YY		28TP50H##A7YY			
		POLYOLEFIN	450	03, 60, 57		27P050HB##A7YY		28P050HB##A7YY			
		PHENOLIC	600	03, 60, 57, 90		27PH50HB##A7YY		28PH50HB##A7YY			
		POLYON AL™	800	03, 60, 57	N, R	27PA50H+##A7YY		28PA50H+##A7YY			
		POLY-PRO™	450	03, 60, 57	D, K, S, U	27PP50H+##A7YY		28PP50H+##A7YY			
		POLYON™	800		G, V	27PU50H+03A7YY		28PU50H+03A7YY			
		ENERGY SAVER POLYON™	800			27SW50HU03A7YY		28SW50HU03A7YY			
		BRIMSTONE®	800	03, 90		27GN50HQ##A7YY		28GN50HQ##A7YY			
		SEMI-STEEL	600			27SS50HS03A7YY		28SS50HS03A7YY			
		5		YOKE ONLY				27ZZ50JZ83**YY	39ZZ50JZ83A7YY	28ZZ50JZ83**YY	DTZZ50JZ8317YY
NEO-ENERGIZER™	550			04, 09, 60'		27EN50JB##**YY	39EN50JB##A7YY	28EN50JB##**YY	DTEN50JB##17YY	FTEN50JB##17YY	
NOMADIC™	500			04, 09, 48, 60, 57	B, I	27NM50J+##**YY	39NM50J+##A7YY	28NM50J+##**YY	DTNM50J+##17YY	FTNM50J+##17YY	
RUBBER ON NYLON	450			04, 09, 48, 60, 57		27NR50JB##**YY	39NR50JB##A7YY	28NR50JB##**YY	DTNR50JB##17YY	FTNR50JB##17YY	
RUBBER ON ALUMINUM	500			04, 09, 48, 60, 57		27RA50JB##**YY	39RA50JB##A7YY	28RA50JB##**YY	DTRA50JB##17YY	FTRA50JB##17YY	
MOLD-ON RUBBER	400			04, 09, 60, 48, 57		27RS50JB##**YY	39RS50JB##A7YY	28RS50JB##**YY	DTRS50JB##17YY	FTRS50JB##17YY	
CUSHENDURE™	400					27GR50JB19**YY	39GR50JB19A7YY	28GR50JB19**YY	DTGR50JB1917YY	FTGR50JB1917YY	
THERMO-PRO™	350			04, 09, 60, 48, 63, 57	A, I, T, X, Y, Z	27TP50J+##**YY	39TP50J+##A7YY	28TP50J+##**YY	DTPP50J+##17YY	FTTP50J+##17YY	
POLYOLEFIN	650				B.E	27P050J+##**YY	39P050J+##A7YY	28P050J+##**YY	DTP050J+##17YY	FTP050J+##17YY	
NYLON	900			04, 09, 60, 48, 53, P3, 57		27NY50JE##**YY	39NY50JE##A7YY	28NY50JE##**YY	DTNY50JE##17YY	FTNY50JE##17YY	
IRONMAN	1250			65, 73		27NX50JB##**YY	39NX50JB##A7YY	28NX50JB##**YY	DTNX50JB##17YY	FTNX50JB##17YY	
ROKHARD™	900			04, 09, 48, 60, 57		27HI50JB##**YY	39HI50JB##A7YY	28HI50JB##**YY	DTHI50JB##17YY	FTHI50JB##17YY	
BRIMSTONE®	1000			04, 09, 60, 90		27GN50JQ##**YY	39GN50JQ##A7YY	28GN50JQ##**YY	DTGN50JQ##17YY	FTGN50JQ##17YY	
EPOXY	1000			04, 09, 90		27OV50JQ##**YY	39OV50JQ##A7YY	28OV50JQ##**YY	DTOV50JQ##17YY	FTOV50JQ##17YY	
MAXROK™	1000			04, 09, 60, 48, 57		27MA50JB##**YY	39MA50JB##A7YY	28MA50JB##**YY	DTMA50JB##17YY	FTMA50JB##17YY	



# DURABLE SUPERIOR CASTERS®

27/28/39/DT/FT – MEDIUM DUTY SERIES (OEM PREFERRED SERIES) – 1,250 LB

Wheel Dia.	Thread Width	Wheel Type	Load Cap.	Available Bearing Options	+ Color	Replace + with a desired wheel color. Replace ## with desired wheel bearing. Replace * with desired fastening pattern.							
						27 Series Part #	39 Series Part #	28 Series Part #	DT Series Part #	FT Series Part #			
5	2	PHENOLIC	1000	04, 09, 60, 48, 57, 90		27PH50JB##**YY	39PH50JB##A7YY	28PH50JB##**YY	DTPH50JB##17YY	FTPH50JB##17YY			
		H-TEMP PHENOLIC	750	04, 09, 90		27HT50JQ##**YY	39HT50JQ##A7YY	28HT50JQ##**YY	DTHT50JQ##17YY	FHT50JQ##17YY			
		STEROLLIZER™	450			27SL50JCB8**YY	39SL50JCB8A7YY	28SL50JCB8**YY	DTSL50JCB817YY	FTSL50JCB817YY			
		POLYON MAXROK™	1000	04, 09, 48, 60, 57	G, K	27MU50J+##**YY	39MU50J+##A7YY	28MU50J+##**YY	DTMU50J+##17YY	FTMU50J+##17YY			
		POLYON AL™	900	04, 09, 48, 60, 57	N, R	27PA50J+##**YY	39PA50J+##A7YY	28PA50J+##**YY	DTPA50J+##17YY	FTPA50J+##17YY			
		POLYON - C	900	04, 09, 48, 60, 57, 12		27PR50JL##**YY	39PR50JL##A7YY	28PR50JL##**YY	DTPR50JL##17YY	FTPR50JL##17YY			
		DW-BLACK	550			27DW50JLT3**YY	39DW50JLT3A7YY	28DW50JLT3**YY	DTDW50JLT317YY	FTDW50JLT317YY			
		DW-RED	750			27DW50JRT3**YY	39DW50JRT3A7YY	28DW50JRT3**YY	DTDW50JRT317YY	FTDW50JRT317YY			
		DW-BLUE	1160			27DW50JBT3**YY	39DW50JBT3A7YY	28DW50JBT3**YY	DTDW50JBT317YY	FTDW50JBT317YY			
		DW-GRAY	1200			27DW50JGT3**YY	39DW50JGT3A7YY	28DW50JGT3**YY	DTDW50JGT317YY	FTDW50JGT317YY			
		POLY-PRO™	600	04, 09, 48, 60, 63, 57	B, C, D, K, U, M, W		27PP50J+##**YY	39PP50J+##A7YY	28PP50J+##**YY	DTPP50J+##17YY	FTPP50J+##17YY		
			700				27PP50JP49**YY	39PP50JP49A7YY	28PP50JP49**YY	DTPP50JP4917YY	FTPP50JP4917YY		
							27PP50JH63**YY	39PP50JH63A7YY	28PP50JH63**YY	DTPP50JH6317YY	FT0050JH6317YY		
		POLYADIC™	750	04, 09, 48, 60, 63, 57	I, M		27PM50J+##**YY	39PM50J+##A7YY	28PM50J+##**YY	DTPM50J+##17YY	FTPM50J+##17YY		
		POLYON™	1100				27PU50JV63**YY	39PU50JV63A7YY	28PU50JV63**YY	DTPU50JV6317YY	FTPU50JV6317YY		
			1100	04, 09, 60, 48	G, V		27PU50J+##**YY	39PU50J+##A7YY	28PU50J+##**YY	DTPU50J+##17YY	FTPU50J+##17YY		
		ENERGY SAVER POLYON™	1250	04, 09, 60, 48			27SW50JU##**YY	39SW50JU##A7YY	28SW50JU##**YY	DTSW50JU##17YY	FTSW50JU##17YY		
		POLYFLEXON™ CAST	800	04, 09, 60, 48			27RP50JK##**YY	39RP50JK##A7YY	28RP50JK##**YY	DTRP50JK##17YY	FTRP50JK##17YY		
		POLYFLEXON™	900		N, O		27UA50J+64**YY	39UA50J+64A7YY	28UA50J+64**YY	DTUA50J+6417YY	FTUA50J+6417YY		
		ULTRAFLEX™	900	64			27UX50JO64**YY	39UX50JO64A7YY	28UX50JO64**YY	DTUX50JO6417YY	FTUX50JO6417YY		
		D-POLYON	900				27UD50JL64**YY	39UD50JL64A7YY	28UD50JL64**YY	DTUD50JL6417YY	FTUD50JL6417YY		
		DURALASTOMER™	900	09, 60, 57			27SU50JL##**YY	39SU50JL##A7YY	28SU50JL##**YY	DTSU50JL##17YY	FTSU50JL##17YY		
		SUPER ELASTOMER	1200				27EE60JI60**YY	39EE60JI60A7YY	28EE60JI60**YY	DTEE60JI6017YY	FTEE60JI6017YY		
		ERGOLASTOMER™	1250	04, 09, 73, 64, 57			27HU50JI##**YY	39HU50JI##A7YY	28HU50JI##**YY	DTHU50JI##17YY	FTHU50JI##17YY		
		SEMI-STEEL	1000	04, 09			27SS50JS##**YY	39SS50JS##A7YY	28SS50JS##**YY	DTSS50JS##17YY	FTSS50JS##17YY		
		HEAVY DUTY IRON	1200	04, 09, 63			27HS50JS##**YY	39HS50JS##A7YY	28HS50JS##**YY	DTHS50JS##17YY	FTHS50JS##17YY		
		DUCTILE	1250	04, 09, 73, 63, B1, B5			27DS50JR##**YY	39DS50JR##A7YY	28DS50JR##**YY	DTDS50JR##17YY	FDDS50JR##17YY		
		FORGED STEEL	1250	02, 09, B5, B1			27FS50JS##**YY	39FS50JS##A7YY	28FS50JS##**YY	DTFS50JS##17YY	FTFS50JS##17YY		
		ENERGY SAVER DUCTILE™	1250	04, 09, B1, B5			27CD50JR##**YY	39CD50JR##A7YY	28CD50JR##**YY	DTCD50JR##17YY	FTCD50JR##17YY		
		IRON V-GROOVE	900	04, 09			27VG50JT##**YY	39VG50JT##A7YY	28VG50JT##**YY	DTVG50JT##17YY	FTVG50JT##17YY		
6	1-1/2	YOKE ONLY					27Z260HZ83A7YY		28Z260HZ83A7YY				
		MOLD-ON RUBBER	450	03, 60, 57			27RS60HB##A7YY		28RS60HB##A7YY				
		THERMO-PRO™	375	03, 60, 57			27TP60HI##A7YY		28TP60HI##A7YY				
		POLYOLEFIN	400	03, 60, 90	B, E		27PO60H+##A7YY		28PO60H+##A7YY				
		PHENOLIC	800	03, 60, 57			27PH60HB##A7YY		28PH60HB##A7YY				
		POLYON AL™	900	03, 60	N, R		27PA60H+##A7YY		28PA60H+##A7YY				
		POLY-PRO™	600	03, 60, 57	K, T, U		27PP60H+##A7YY		28PP60H+##A7YY				
		POLYON™	800		G, V		27PU60H+03A7YY		28PU60H+03A7YY				
		ENERGY SAVER POLYON™	850				27SW60HU03A7YY		28SW60HU03A7YY				
		SEMI-STEEL	700				27SS60HS03A7YY		28SS60HS03A7YY				
		SOLID STEEL V-GROOVE	1250				27SV60IT14A7YY		28SV60IT14A7YY				
		6	2	YOKE ONLY					27Z260JZ83**YY	39Z260JZ83A7YY	28Z260JZ83**YY	DTZ260JZ8317YY	FTZ260JZ8317YY
				NEO-ENERGIZER™	600	04, 09, 60			27EN60JB##**YY	39EN60JB##A7YY	28EN60JB##**YY	DTEN60JB##17YY	FTEN60JB##17YY
				PNEUMATIC	200				27FP60JB60**YY	39FP60JB60A7YY	28FP60JB60**YY	DTFP60JB6017YY	FTFP60JB6017YY
				FOAM FILLED	200				27FF60JB60**YY	39FF60JB60A7YY	28FF60JB60**YY	DTFF60JB6017YY	FTFF60JB6017YY
EVER-ROLL™	200				B, I		27ER60J+60**YY	39ER60J+60**YY	28ER60J+60**YY	DTER60J+6017YY	FTER60J+6017YY		
NOMADIC™	600			04, 09, 48, 60, 57			27NM60JB##**YY	39NM60JB##A7YY	28NM60JB##**YY	DTNM60JB##17YY	FTNM60JB##17YY		
RUBBER ON NYLON	550			04, 09, 48, 60, 57			27NR60JB##**YY	39NR60JB##A7YY	28NR60JB##**YY	DTNR60JB##17YY	FTNR60JB##17YY		
DURA-CUSHION™	350			04, 09, 63	X, Z		27BC60J+##**YY	39BC60J+##A7YY	28BC60J+##**YY	DTBC60J+##17YY	FTBC60J+##17YY		
ECO-RUBBER	350			53, P3			27SN60JC##**YY	39SN60JC##A7YY	28SN60JC##**YY	DTSN60JC##17YY	FTSN60JC##17YY		
								39SN67JC##A7YY	28SN67JC##A7YY				
RUBBER ON ALUMINUM	550			04, 09, 48, 60, 57			27RA60JB##**YY	39RA60JB##A7YY	28RA60JB##**YY	DTRA60JB##17YY	FTRA60JB##17YY		
LOW PROFILE RUBBER	600						27LP60JB04**YY	39LP60JB04A7YY	28LP60JB04**YY	DTLP60JB0417YY	FTLP60JB0417YY		





27/28/39/DT/FT – MEDIUM DUTY SERIES (OEM PREFERRED SERIES) – 1,250 LB

Wheel Dia.	Thread Width	Wheel Type	Load Cap.	Available Bearing Options	+ Color	Replace + with a desired wheel color. Replace ## with desired wheel bearing. Replace ** with desired fastening pattern.				
						27 Series Part #	39 Series Part #	28 Series Part #	DT Series Part #	FT Series Part #
6	2	MOLD-ON RUBBER	550	04, 09, 48, 60, 57		27RS60JB##**Y	39RS60JB##A7Y	28RS60JB##**Y	DTRS60JB##17Y	FTRS60JB##17Y
		SUPREME RUBBER	700	63, 73		27RH60JS##**YY	39RH60JS##A7YY	28RH60JS##**YY	DTRH60JS##17YY	FTRH60JS##17YY
		THERMO-PRO™	500	04, 09, 60, 63, 48, 57	A, I, T, X, Y, Z	27TP60J+##**YY	39TP60J+##A7YY	28TP60J+##**YY	DTPP60J+##17YY	FTTP60J+##17YY
		POLYOLEFIN	700	04, 09, 60, 53, P3, 48, 57	B, E	27PO60J+##**YY	39PO60J+##A7YY	28PO60J+##**YY	DTPO60J+##17YY	FTPO60J+##17YY
		NYLON	1000	04, 09, 48, 60, 57		27NY60JE##**YY	39NY60JE##A7YY	28NY60JE##**YY	DTNY60JE##17YY	FTNY60JE##17YY
		IRONMAN	1250	65, 73		27NX60JB##**YY	39NX60JB##A7YY	28NX60JB##**YY	DTNX60JB##17YY	FTNX60JB##17YY
		ROKHARD™	1000	04, 09, 48, 60, 57		27HI60JB##**YY	39HI60JB##A7YY	28HI60JB##**YY	DTHI60JB##17YY	FTHI60JB##17YY
		BRIMSTONE®	1100	04, 09, 60, 90		27GN60JQ##**YY	39GN60JQ##A7YY	28GN60JQ##**YY	DTGN60JQ##17YY	FTGN60JQ##17YY
		EPOXY	1100	04, 09, 90		27OV60JQ##**YY	39OV60JQ##A7YY	28OV60JQ##**YY	DTOV60JQ##17YY	FTOV60JQ##17YY
		MAXROK™	1200	04, 09, 60, 48, 57		27MA60JB##**YY	39MA60JB##A7YY	28MA60JB##**YY	DTMA60JB##17YY	FTMA60JB##17YY
		PHENOLIC	1200	04, 09, 60, 48, 57		27PH60JB##**YY	39PH60JB##A7YY	28PH60JB##**YY	DTPH60JB##17YY	FTPH60JB##17YY
		STRAIGHT-SIDED PHENOLIC	1250			27PH60TB##**YY	39PH60TB##**YY	28PH60TB##**YY	DTPH60TB##**YY	FTPH60TB##**YY
		HIGH-TEMP PHENOLIC	900	04, 09, 90		27HT60JQ##**YY	39HT60JQ##A7YY	28HT60JQ##**YY	DHT60JQ##17YY	FHT60JQ##17YY
		POLY MAXROK™	1200	04, 09, 60, 48, 57	G, K	27MU60J+##**YY	39MU60J+##A7YY	28MU60J+##**YY	DTMU60J+##17YY	FTMU60J+##17YY
		POLYON AL™	1200	04, 09, 48, 60, 57	N, R	27PA60J+##**YY	39PA60J+##A7YY	28PA60J+##**YY	DTPA60J+##17YY	FTPA60J+##17YY
		POLYON-C	1200	04, 09, 48, 60, 57, 12		27PR60JL##**YY	39PR60JL##A7YY	28PR60JL##**YY	DTPR60JL##17YY	FTPR60JL##17YY
		DW-BLACK	700			27DW60JLT3**YY	39DW60JLT3A7YY	28DW60JLT3**YY	DTDW60JLT317YY	FTDW60JLT317YY
		DW-RED	960			27DW60JRT3**YY	39DW60JRT3A7YY	28DW60JRT3**YY	DTDW60JRT317YY	FTDW60JRT317YY
		DW-BLUE	1250			27DW60JBT3**YY	39DW60JBT3A7YY	28DW60JBT3**YY	DTDW60JBT317YY	FTDW60JBT317YY
		DW-GRAY	1250			27DW60JGT3**YY	39DW60JGT3A7YY	28DW60JGT3**YY	DTDW60JGT317YY	FTDW60JGT317YY
		POLY-PRO™	720	04, 09, 48, 60, 57, 63	D, I, K, M, W, U	27PP60J+##**YY	39PP60J+04A7YY	28PP60J+##**YY	DTPP60J+0417YY	FTPP60J+0417YY
			900			27PP60JP49**YY	39PP60JP49A7YY	28PP60JP49**YY	DTPP60JP4917YY	FTPP60JP4917YY
						27PP60JH63**YY	39PP60JH63A7YY	28PP60JH63**YY	DTPP60JH6317YY	FTPP60JH6317YY
		POLYADIC™	900	04, 09, 48, 60, 63, 57	I, M	27PM60J+##**YY	39PM60J+##A7YY	28PM60J+##**YY	DTPM60J+##17YY	FTPM60J+##17YY
		POLYON™	1200			27PU60JV63**YY	39PU60JV63A7YY	28PU60JV63**YY	DTPU60JV6317YY	FTPU60JV6317YY
				04, 09, 60	G, V	27PU60J+##**YY	39PU60J+##A7YY	28PU60J+##**YY	DTPU60J+##17YY	FTPU60J+##17YY
		ENERGY SAVER POLYON™	1250	04, 09, 63, 73		27SW60JU##**YY	39SW60JU##A7YY	28SW60JU##**YY	DTSW60JU##17YY	FTSW60JU##17YY
		POLYFLEXON™ CAST	900	04, 09, 60, 48, 57		27RP60JK##**YY	39RP60JK##A7YY	28RP60JK##**YY	DTRP60JK##17YY	FTRP60JK##17YY
		POLYFLEXON™	900		N, O	27UA60J+64**YY	39UA60J+64A7YY	28UA60J+64**YY	DTUA60J+6417YY	FTUA60J+6417YY
		D-POLYON	1000			27UD60JL64**YY	39UD60JL64A7YY	28UD60JL64**YY	DTUD60JL6417YY	FTUD60JL6417YY
		ULTRAFLEX™	1000			27UX60JO64**YY	39UX60JO64A7YY	28UX60JO64**YY	DTUX60JO6417YY	FTUX60JO6417YY
		CHAMPION	1200			27CP60JN64**YY	39CP60JN64A7YY	28CP60JN64**YY	DTCP60JN6417YY	FTCP60JN6417YY
		DURALASTOMER™	1000	09, 60, 57		27SU60JL##**YY	39SU60JL##A7YY	28SU60JL##**YY	DTSU60JL##17YY	FTSU60JL##17YY
		SUPER ELASTOMER	1250			27EE60JI60**YY	39EE60JI60A7YY	28EE60JI60**YY	DTEE60JI6017YY	FTEE60JI6017YY
		ERGOLASTOMER™	1250	04, 09, 73, 64, 57		27HU60JI##**YY	39HU60JI##A7YY	28HU60JI##**YY	DTHU60JI##17YY	FTHU60JI##17YY
		SEMI-STEEL	1200	04, 09		27SS60JS##**YY	39SS60JS##A7YY	28SS60JS##**YY	DTSS60JS##17YY	FTSS60JS##17YY
		HEAVY DUTY IRON	1250	04, 09, 63		27HS60JS##**YY	39HS60JS##A7YY	28HS60JS##**YY	DTHS60JS##17YY	FTHS60JS##17YY
		DUCTILE	1250	04, 09, 73, 63, B1, B5		27DS60JR##**YY	39DS60JR##A7YY	28DS60JR##**YY	DTDS60JR##17YY	FTDS60JR##17YY
		ENERGY SAVER DUCTILE™	1250	04, 09, B1, B5		27CD60JR##**YY	39CD60JR##A7YY	28CD60JR##**YY	DTCD60JR##17YY	FTCD60JR##17YY
		FORGED STEEL	1250	04, 09, 73, 63, B1, B5		27FS60JS##**YY	39FS60JS##A7YY	28FS60JS##**YY	DTFS60JS##17YY	FTFS60JS##17YY
		IRON V-GROOVE	1000	04, 09		27VG60JT##**YY	39VG60JT##A7YY	28VG60JT##**YY	DTVG60JT##17YY	FTVG60JT##17YY
		DUCTILE V-GROVE	1250	04, 09, B1, B5		27DV60JT##**YY	39DV60JT##A7YY	28DV60JT##**YY	DTDV60JT##17YY	FTDV60JT##17YY
		YOKE ONLY				27Z261JZ83A7YY		28Z261JZ83A7YY		
		NEO-ENERGIZER™	600	04, 09, 60		27EN61JB##A7YY		28EN61JB##A7YY		
		PNEUMATIC	150			27FP61JB60A7YY		28FP61JB60A7YY		
FOAM FILLED	200			27FF61JB60A7YY		28FF61JB60A7YY				
EVER-ROLL™	150		B, I	27ER61J+60A7YY		28ER61J+60A7				
NOMADIC™	600	04, 09, 48, 60, 57		27NM61JB##A7YY		28NM61JB##A7YY				



# DURABLE SUPERIOR CASTERS®

27/28/39/DT/FT – MEDIUM DUTY SERIES (OEM PREFERRED SERIES) – 1,250 LB

Wheel Dia.	Thread Width	Wheel Type	Load Cap.	Available Bearing Options	+ Color	Replace + with a desired wheel color. Replace ## with desired wheel bearing. Replace * with desired fastening pattern.				
						27 Series Part #	39 Series Part #	28 Series Part #	DT Series Part #	FT Series Part #
6	2	RUBBER ON NYLON	550	04, 09, 48, 60, 57		27NR61JB##A7YY		28NR61JB##A7YY		
		DURA-CUSHION™	350	04, 09, 63	X, Z	27BC61J+##A7YY		28BC61J+##A7YY		
		ECO-RUBBER	350	53, P3		27SN61JC##A7YY		28SN61JC##A7YY		
		RUBBER ON ALUMINUM	550	04, 09, 48, 60, 57		27RA61JB##A7YY		28RA61JB##A7YY		
		LOW PROFILE RUBBER	600			27LP61JB##A7YY		28LP61JB##A7YY		
		MOLD-ON RUBBER	550	04, 09, 48, 60, 57		27RS61JB##A7YY		28RS61JB##A7YY		
		SUPREME RUBBER	700	63, 73		27RH61JS##A7YY		28RH61JS##A7YY		
		THERMO-PRO™	500	04, 09, 60, 63, 48, 57	A, I, T, X, Y, Z	27TP61J+##A7YY		28TP61J+##A7YY		
		POLYOLEFIN	700	04, 09, 60, 53, P3, 48, 57	B, E	27PO61J+##A7YY		28PO61J+##A7YY		
		NYLON	1000	04, 09, 48, 60, 57		27NY61JE##A7YY		28NY61JE##A7YY		
		IRONMAN	1250	65, 73		27NX61JB##A7YY		28NX61JB##A7YY		
		ROKHARD™	1000	04, 09, 48, 60, 57		27HI61JB##A7YY		28HI61JB##A7YY		
		BRIMSTONE®	1100	04, 09, 60, 90		27GN61JQ##A7YY		28GN61JQ##A7YY		
		EPOXY	1100	04, 09, 90		27OV61JQ##A7YY		28OV61JQ##A7YY		
		MAXROK™	1200	04, 09, 60, 48, 57		27MA61JB##A7YY		28MA61JB##A7YY		
		PHENOLIC	1200	04, 09, 60, 48, 57		27PH61JB##A7YY		28PH61JB##A7YY		
		STRAIGHT-SIDED PHENOLIC	1250			27PH61TB##A7YY		28PH61TB##A7YY		
		HIGH-TEMP PHENOLIC	900	04, 09, 90		27HT61JQ##A7YY		28HT61JQ##A7YY		
		POLY MAXROK™	1200	04, 09, 60, 48, 57	G, K	27MU61J+##A7YY		28MU61J+##A7YY		
		POLYON AL™	1200	04, 09, 48, 60, 57	N, R	27PA61J+##A7YY		28PA61J+##A7YY		
		POLYON-C	1200	04, 09, 48, 60, 57, 12		27PR61JL##A7YY		28PR61JL##A7YY		
		DW-BLACK	700			27DW61JLT3A7YY		28DW61JLT3A7YY		
		DW-RED	960			27DW61JRT3A7YY		28DW61JRT3A7YY		
		DW-BLUE	1250			27DW61JBT3A7YY		28DW61JBT3A7YY		
		DW-GRAY	1250			27DW61JGT3A7YY		28DW61JGT3A7YY		
		POLY-PRO™	720	04, 09, 48, 60, 57, 63	D, I, K, M, W, U	27PP61J+##A7YY		28PP61J+##A7YY		
			900			27PP61JP49A7YY		28PP61JP49A7YY		
		POLYADIC™	900	04, 09, 48, 60, 63, 57	I, M	27PM61J+##A7YY		28PM61J+##A7YY		
			1200	04, 09, 60	G, V	27PU61JV63A7YY		28PU61JV63A7YY		
		ENERGY SAVER POLYON™	1250	04, 09, 63, 73		27SW61JU##A7YY		28SW61JU##A7YY		
		POLYFLEXON™ CAST	900	04, 09, 60, 48, 57		27RP61JK##A7YY		28RP61JK##A7YY		
		POLYFLEXON™	1000		N, O	27UA61J+64A7YY		28UA61J+64A7YY		
		D-POLYON	1000			27UD61JL64A7YY		28UD61JL64A7YY		
		ULTRAFLEX™	1000			27UX60JO64A7YY		28UX60JO64A7YY		
		CHAMPION	1200			27CP61JN64A7YY		28CP61JN64A7YY		
		DURALASTOMER™	1000	09, 60, 57		27SU61JL##A7YY		28SU61JL##A7YY		
		SUPER ELASTOMER	1250			27EE61JI60A7YY		28EE61JI60A7YY		
		ERGOLASTOMER™	1250	04, 09, 73, 64, 57		27HU61JI##A7YY		28HU61JI##A7YY		
		SEMI-STEEL	1200	04, 09		27SS61JS##A7YY		28SS61JS##A7YY		
		HEAVY DUTY IRON	1250	04, 09, 63		27HS61JS##A7YY		28HS61JS##A7YY		
		DUCTILE	1250	04, 09, 73, 63, B1, B5		27DS61JR##A7YY		28DS61JR##A7YY		
		ENERGY SAVER DUCTILE™	1250	04, 09, B1, B5		27CD61JR##A7YY		28CD61JR##A7YY		
		FORGED STEEL	1250	04, 09, 73, 63, B1, B5		27FS61JS##A7YY		28FS61JS##A7YY		
		IRON V-GROOVE	1000	04, 09		27VG61JT##A7YY		28VG61JT##A7YY		
		DUCTILE V-GROOVE	1250	04, 09, B1, B5		27DV61JT##A7YY		28DV61JT##A7YY		



27/28/39/DT/FT – MEDIUM DUTY SERIES (OEM PREFERRED SERIES) – 1,250 LB

Wheel Dia.	Thread Width	Wheel Type	Load Cap.	Available Bearing Options	+ Color	Replace + with a desired wheel color. Replace ## with desired wheel bearing. Replace ** with desired fastening pattern.						
						27 Series Part #	39 Series Part #	28 Series Part #	DT Series Part #	FT Series Part #		
8	2	YOKE ONLY					27Z280JZ83**YY	39Z280JZ83A7YY	28Z280JZ83**YY	DTZ280JZ8317YY	FTZ280JZ8317YY	
		NEO-ENERGIZER™	600	04, 09, 60			27EN80JB##**YY	39EN80JB##A7YY	28EN80JB##**YY	DTEN80JB##17YY	FTEN80JB##17YY	
		NOMADIC™	700	04, 09, 48, 60, 57	B, I		27NM80J+##**YY	39NM80J+##A7YY	28NM80J+##**YY	DTNM80J+##17YY	FTNM80J+##17YY	
		RUBBER ON NYLON	600	04, 09, 48, 60, 57			27NR80JB##**YY	39NR80JB##A7YY	28NR80JB##**YY	DTNR80JB##17YY	FTNR80JB##17YY	
		DURA-CUSHION™	450	04, 09, 63	X, Z		27BC80J+##**YY	39BC80J+##A7YY	28BC80J+##**YY	DTBC80J+##17YY	FTBC80J+##17YY	
		ECO-RUBBER	450	53, P3			27SN80UC##**YY	39SN80UC##A7YY	28SN80UC##**YY	DTSN80UC##17YY	FTSN80UC##17YY	
		RUBBER ON ALUMINUM	600	04, 09, 48, 60, 57			27RA80JB##**YY	39RA80JB##A7YY	28RA80JB##**YY	DTRA80JB##17YY	FTRA80JB##17YY	
		MOLD-ON RUBBER	600	04, 09, 48, 60, 57			27RS80JB##**YY	39RS80JB##A7YY	28RS80JB##**YY	DTRS80JB##17YY	FTRS80JB##17YY	
		SUPREME RUBBER	810	63, 73			27RH80JS##**YY	39RH80JS##A7YY	28RH80JS##**YY	DTRH80JS##17YY	FRH80JS##17YY	
		THERMO-PRO™	600	04, 09, 60, 63, 48, 57	A, I, T, X, Y, Z,		27TP80J+##**YY	39TP80J+##A7YY	28TP80J+##**YY	DTPP80J+##17YY	FTTP80J+##17YY	
		POLYOLEFIN	900	04, 09, 60, 53, P3, 48, 57, 90	B, E		27P080J+##**YY	39P080J+##A7YY	28P080J+##**YY	DTP080J+##17YY	FTP080J+##17YY	
		NYLON	1100	04, 09, 60, 48, 57			27NY80JE##**YY	39NY80JE##A7YY	28NY80JE##**YY	DTNY80JE##17YY	FTNY80JE##17YY	
		IRONMAN	1250	65, 73			27NX80JB##**YY	39NX80JB##A7YY	28NX80JB##**YY	DTNX80JB##17YY	FTNX80JB##17YY	
		ROKHARD™	1100	04, 09, 48, 60, 57			27HI80JB##**YY	39HI80JB##A7YY	28HI80JB##**YY	DTHI80JB##17YY	FTHI80JB##17YY	
		BRIMSTONE®	1200	04, 09, 60, 90			27GN80JQ##**YY	39GN80JQ##A7YY	28GN80JQ##**YY	DTGN80JQ##17YY	FTGN80JQ##17YY	
		EPOXY	1200	04, 09, 90			27OV80JQ##**YY	39OV80JQ##A7YY	28OV80JQ##**YY	DTOV80JQ##17YY	FTOV80JQ##17YY	
		MAXROK™	1250	04, 09, 48, 60, 57			27MA80JB##**YY	39MA80JB##A7YY	28MA80JB##**YY	DTMA80JB##17YY	FTMA80JB##17YY	
		PHENOLIC	1250	04, 09, 60, 57			27PH80JB##**YY	39PH80JB##A7YY	28PH80JB##**YY	DTPH80JB##17YY	FTPH80JB##17YY	
		HIGH-TEMP PHENOLIC	1100	04, 09, 60, 90			27HT80JQ##**YY	39HT80JQ##A7YY	28HT80JQ##**YY	DHT80JQ##17YY	FHT80JQ##17YY	
		POLY MAXROK™	1250	04, 09, 48, 60, 57	G, K		27MU80J+##**YY	39MU80J+##A7YY	28MU80J+##**YY	DTMU80J+##17YY	FTMU80J+##17YY	
		POLYON AL™	1250	04, 09, 48, 60, 57	N, R		27PA80J+##**YY	39PA80J+##A7YY	28PA80J+##**YY	DTPA80J+##17YY	FTP80J+##17YY	
		DW-BLACK	750				27DW80JLT3**YY	39DW80JLT3A7YY	28DW80JLT3**YY	DTDW80JLT317YY	FTDW80JLT317YY	
		DW-RED	1100				27DW80JRT3**YY	39DW80JRT3A7YY	28DW80JRT3**YY	DTDW80JRT317YY	FTDW80JRT317YY	
		DW-BLUE	1250				27DW80JBT3**YY	39DW80JBT3A7YY	28DW80JBT3**YY	DTDW80JBT317YY	FTDW80JBT317YY	
		DW-GRAY	1250				27DW80JGT3**YY	39DW80JGT3A7YY	28DW80JGT3**YY	DTDW80JGT317YY	FTDW80JGT317YY	
		POLY-PRO™	810	04, 09, 48, 60, 63, 57	C, D, I, K, M, U, W		27PP80J+##**YY	39PP80J+##A7YY	28PP80J+##**YY	DTPP80J+##17YY	FTPP80J+##17YY	
			1000				27PP80JP49**YY	39PP80JP49A7YY	28PP80JP49**YY	DTPP80JP4917YY	FTPP80JP4917YY	
			1000				27PP80JH63**YY	39PP80JH63A7YY	28PP80JH63**YY	DTPP80JH6317YY	FTPP80JH6317YY	
		POLYMADIC™	1000	04, 09, 48, 60, 63, 57	I, M		27PM80J+##**YY	39PM80J+##A7YY	28PM80J+##**YY	DTPM80J+##17YY	FTPM80J+##17YY	
		POLYON™	1250				27PU80JV63**YY	39PU80JV63A7YY	28PU80JV63**YY	DTPU80JV6317YY	FTPU80JV6317YY	
				04, 09, 60	G, V		27PU80J+##**YY	39PU80J+##A7YY	28PU80J+##**YY	DTPU80J+##17YY	FTPU80J+##17YY	
		ENERGY SAVER POLYON™	1250	04, 09, 60			27SW80JU##**YY	39SW80JU##A7YY	28SW80JU##**YY	DTSW80JU##17YY	FTSW80JU##17YY	
		POLYFLEXON™ CAST	1000				27RP80JK63**YY	39RP80JK63A7YY	28RP80JK63**YY	DTRP80JK6317YY	FTRP80JK6317YY	
		POLYFLEXON™	1200		N, O		27UA80J+64**YY	39UA80J+64A7YY	28UA80J+64**YY	DTUA80J+6417YY	FTUA80J+6417YY	
		D-POLYON	1200				27UD80JL64**YY	39UD80JL64A7YY	28UD80JL64**YY	DTUD80JL6417YY	FTUD80JL6417YY	
		ULTRAFLEX™	1200				27UX80JO64**YY	39UX80JO64A7YY	28UX80JO64**YY	DTUX80JO6417YY	FTUX80JO6417YY	
		CHAMPION	1250				27CP80JN64**YY	39CP80JN64A7YY	28CP80JN64**YY	DTCP80JN6417YY	FTCP80JN6417YY	
		DURALASTOMER™	1000	09, 60, 63, 57			27SU80JL##**YY	39SU80JL##A7YY	28SU80JL##**YY	DTSU80JL##17YY	FTSU80JL##17YY	
		SUPER ELASTOMER	1250				27EE80JI60**YY	39EE80JI60A7YY	28EE80JI60**YY	DTEE80JI6017YY	FTEE80JI6017YY	
		ERGOLASTOMER™	1250	04, 09, 73, 64, 57			27HU80JI##**YY	39HU80JI##A7YY	28HU80JI##**YY	DTHU80JI##17YY	FTHU80JI##17YY	
		SEMI-STEEL	1250	04, 09			27SS80JS##**YY	39SS80JS##A7YY	28SS80JS##**YY	DTSS80JS##17YY	FTSS80JS##17YY	
		HEAVY DUTY IRON	1250	04, 09, 63			27HS80JS##**YY	39HS80JS##A7YY	28HS80JS##**YY	DTHS80JS##17YY	FTHS80JS##17YY	
		DUCTILE	1250	04, 09, 63, 73, B1, B5			27DS80JR##**YY	39DS80JR##A7YY	28DS80JR##**YY	DTDS80JR##17YY	FTDS80JR##17YY	
		ENERGY SAVER DUCTILE™	1250	04, 09, B1, B5			27CD80JR##**YY	39CD80JR##A7YY	28CD80JR##**YY	DTCD80JR##17YY	FTCD80JR##17YY	
		FORGED STEEL	1250	04, 09, 73, 63, B5, B1			27FS80JS##**YY	39FS80JS##A7YY	28FS80JS##**YY	DTFS80JS##17YY	FTFS80JS##17YY	
		IRON V-GROOVE	1200	04, 09			27VG80JT##**YY	39VG80JT##A7YY	28VG80JT##**YY	DTVG80JT##17YY	FTVG80JT##17YY	
		YOKE ONLY						27Z281JZ83A7YY		28Z281JZ83A7YY		
		NEO-ENERGIZER™	600	04, 09, 60			27EN81JB##A7YY		28EN81JB##A7YY			



# DURABLE SUPERIOR CASTERS®

27/28/39/DT/FT – MEDIUM DUTY SERIES (OEM PREFERRED SERIES) – 1,250 LB

Wheel Dia.	Thread Width	Wheel Type	Load Cap.	Available Bearing Options	+ Color	Replace + with a desired wheel color. Replace ## with desired wheel bearing. Replace * with desired fastening pattern.				
						27 Series Part #	39 Series Part #	28 Series Part #	DT Series Part #	FT Series Part #
8	2	NOMADIC™	700	04, 09, 48, 60, 57	B, I	27NM81J+##A7YY		28NM81J+##A7YY		
		RUBBER ON NYLON	600	04, 09, 48, 60, 57		27NR81JB##A7YY		28NR81JB##A7YY		
		DURA-CUSHION™	450	04, 09, 63	X, Z	27BC81J+##A7YY		28BC81J+##A7YY		
		ECO-RUBBER	450	53, P3		27SN81UC##A7YY		28SN81UC##A7YY		
		RUBBER ON ALUMINUM	600	04, 09, 48, 60, 57		27RA81JB##A7YY		28RA81JB##A7YY		
		MOLD-ON RUBBER	600	04, 09, 48, 60, 57		27RS81JB##A7YY		28RS81JB##A7YY		
		SUPREME RUBBER	810	63, 73		27RH81JS##A7YY		28RH81JS##A7YY		
		THERMO-PRO™	600	04, 09, 60, 63, 48, 57	A, I, T, X, Y, Z,	27TP81J+##A7YY		28TP81J+##A7YY		
		POLYOLEFIN	900	04, 09, 60, 53, P3, 48, 57, 90	B, E	27P081J+##A7YY		28P081J+##A7YY		
		NYLON	1100	04, 09, 60, 48, 57		27NY81JE##A7YY		28NY81JE##A7YY		
		IRONMAN	1250	65, 73		27NX81JB##A7YY		28NX81JB##A7YY		
		ROKHARD™	1100	04, 09, 48, 60, 57		27HI81JB##A7YY		28HI81JB##A7YY		
		BRIMSTONE®	1200	04, 09, 60, 90		27GN81JQ##A7YY		28GN81JQ##A7YY		
		EPOXY	1200	04, 09, 90		27OV81JQ##A7YY		28OV81JQ##A7YY		
		MAXROK™	1250	04, 09, 48, 60, 57		27MA81JB##A7YY		28MA81JB##A7YY		
		PHENOLIC	1250	04, 09, 60, 57		27PH81JB##A7YY		28PH81JB##A7YY		
		HIGH-TEMP PHENOLIC	1100	04, 09, 60, 90		27HT81JQ##A7YY		28HT81JQ##A7YY		
		POLY MAXROK™	1250	04, 09, 48, 60, 57	G, K	27MU81J+##A7YY		28MU81J+##A7YY		
		POLYON AL™	1250	04, 09, 48, 60, 57	N, R	27PA81J+##A7YY		28PA81J+##A7YY		
		DW-BLACK	750			27DW81JLT3A7YY		28DW81JLT3A7YY		
		DW-RED	1100			27DW81JRT3A7YY		28DW81JRT3A7YY		
		DW-BLUE	1250			27DW81JBT3A7YY		28DW81JBT3A7YY		
		DW-GRAY	1250			27DW81JGT3A7YY		28DW81JGT3A7YY		
		POLY-PRO™	810	04, 09, 48, 60, 63, 57	C, D, I, K, M, U, W	27PP81J+##A7YY		28PP81J+##A7YY		
			1000			27PP81JP49A7YY		28PP81JP49A7YY		
			1000			27PP81JH63A7YY		28PP81JH63A7YY		
		POLYADIC™	1000	04, 09, 48, 60, 63, 57	I, M	27PM81J+##A7YY		28PM81J+##A7YY		
		POLYON™	1250			27PU81JV63A7YY		28PU81JV63A7YY		
				04, 09, 60	G, V	27PU81J+##A7YY		28PU81J+##A7YY		
		ENERGY SAVER POLYON™	1250	04, 09, 60		27SW81JU##A7YY		28SW81JU##A7YY		
		POLYFLEXON™ CAST	1000			27RP81JK63A7YY		28RP81JK63A7YY		
		POLYFLEXON™	1200		N, O	27UA81J+64A7YY		28UA81J+64A7YY		
		D-POLYON	1200			27UD81JL64A7YY		28UD81JL64A7YY		
		ULTRAFLEX™	1200			27UX81JO64A7YY		28UX81JO64A7YY		
		CHAMPION	1250			27CP81JN64A7YY		28CP81JN64A7YY		
		DURALASTOMER™	1000	09, 60, 63, 57		27SU81JL##A7YY		28SU81JL##A7YY		
		SUPER ELASTOMER	1250			27EE81JI60A7YY		28EE81JI60A7YY		
		ERGOLASTOMER™	1250	04, 09, 73, 64, 57		27HU81JI##A7YY		28HU81JI##A7YY		
		SEMI-STEEL	1250	04, 09		27SS81JS##A7YY		28SS81JS##A7YY		
		HEAVY DUTY IRON	1250	04, 09, 63		27HS81JS##A7YY		28HS81JS##A7YY		
DUCTILE	1250	04, 09, 63, 73, B1, B5		27DS81JR##A7YY		28DS81JR##A7YY				
ENERGY SAVER DUCTILE™	1250	04, 09, B1, B5		27CD81JR##A7YY		28CD81JR##A7YY				
FORGED STEEL	1250	04, 09, 73, 63, B5, B1		27FS81JS##A7YY		28FS81JS##A7YY				
IRON V-GROOVE	1200	04, 09		27VG81JT##A7YY		28VG81JT##A7YY				
10	2	YOKE ONLY				27ZZ10JZ83A7YY		28ZZ10JZ83A7YY		
		MOLD-ON RUBBER	700	04, 09, 60		27RS10JB##A7YY		28RS10JB##A7YY		
		MAXROK™	1250	04, 09, 60		27MA10JB##A7YY		28MA10JB##A7YY		

# 49/50 – MOMENTUM™ – PRECISION TAPERED RACEWAY SERIES – 2,000 LB



- Constructed from ASTM1045
- 3/4" integrally forged kingpin
- 2-9/16" bearing raceway is precisely machined and hardened. 3/8" hardened ball bearings
- Lower raceway thrust bearing is a tapered roller bearing, providing

- exceptionally smooth and easy swiveling action and counteracts radial thrust
- 1/4" thick legs are double welded
- Zinc-plated finish
- Grease fitting on raceway and axle
- 1/2" axle

Integrally forged 1 pc plate, and kingpin raceway is precisely machined and hardened.

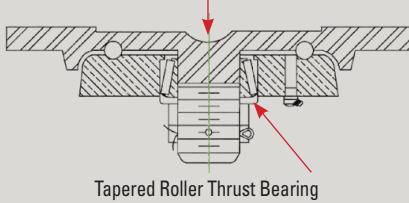

FASTENING PATTERN

Plate Code	Overall Size	Bolt Hole Patter	Mounting Bolt Size
17	4 X 4-1/2	2-5/8 X 3-5/8 TO 3 X 3	3/8

WHEEL DIAMETER, OVERALL HEIGHTS, OFFSETS AND SWIVEL RADIUS

Wheel Diameter	Designation Code	Overall Heights	Offset	Swivel Radius
4	40	5-5/8	1-9/16	3-9/16
5	50	6-1/2	2	4-1/2
6	60	7-1/2	2-3/16	5-3/16
8	80	9-1/2	2-3/8	6-3/8

BRAKE OPTIONS

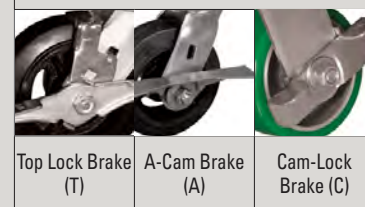

Top Lock Brake (T)    A-Cam Brake (A)    Cam-Lock Brake (C)

OTHER OPTIONS

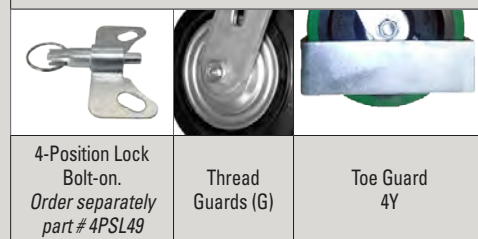

4-Position Lock Bolt-on. Order separately part # 4PSL49    Thread Guards (G)    Toe Guard 4Y

49/50 – MOMENTUM™ – PRECISION TAPERED RACEWAY SERIES – 2,000 LB

Wheel Diameter	Thread Width	Wheel Type	Available Bearing Options	+ Color	Replace + with a desired wheel color. Replace ## with desired wheel bearing.		Load Capacity	
					49 Series Swivel Caster Part #	50 Series Rigid Caster Part #		
4	2	YOKE ONLY				49ZZ40JZ8317YY	50ZZ40JZ8317YY	
		NEO-ENERGIZER™	04, 09, 60			49EN40JB##17YY	50EN40JB##17YY	500
		NOMADIC™	04, 09, 60, 48, 57	I, B		49NM40J+##17YY	50NM40J+##17YY	400
		RUBBER ON NYLON	04, 09, 60, 48, 57			49NR40JB##17YY	50NR40JB##17YY	400
		RUBBER ON ALUMINUM	04, 09, 60, 48, 57			49RA40JB##17YY	50RA40JB##17YY	400
		LOW PROFILE RUBBER				49LP40JB0417YY	50LP40JB0417YY	300
		MOLD-ON RUBBER	04, 09, 60, 48, 57			49RS40JB##17YY	50RS40JB##17YY	400
		THERMO-PRO™	04, 09, 60, 63, 48, 57	A, T, Y		49TP40J+##17YY	50TP40J+##17YY	300
		POLYOLEFIN	04, 09, 60, 63, 48, 57	B, E		49PO40J+##17YY	50PO40J+##17YY	500
		NYLON	04, 09, 60, 63, 48, 57			49NY40JE##17YY	50NY40JE##17YY	800
		IRONMAN	04, 09, 65, 73			49NX40JB##17YY	50NX40JB##17YY	2200
		ROKHARD™	04, 09, 60, 63, 48, 57			49HI40JB##17YY	50HI40JB##17YY	800
		BRIMSTONE®	04, 09, 90			49GN40JQ##17YY	50GN40JQ##17YY	800
		EPOXY	04, 09, 90			49OV40JQ##17YY	50OV40JQ##17YY	800
		MAXROK™	04, 09, 60, 63, 48, 57			49MA40JB##17YY	50MA40JB##17YY	800
		PHENOLIC	04, 09, 60, 63, 48, 57			49PH40JB##17YY	50PH40JB##17YY	800
		PHENOLIC(STRAIGHT SIDED)	04, 09, 60, 57, 12			49PH40TB##17YY	50PH40TB##17YY	1000
		HIGH-TEMP PHENOLIC	04, 09, 90			49HT40JQ##17YY	50HT40JQ##17YY	600
		POLYON MAXROK™	04, 09, 60, 63, 48, 57	G, K		49MU40J+##17YY	50MU40J+##17YY	700
		POLY AL™	04, 09, 60, 63, 48, 57	N, R		49PA40J+##17YY	50PA40J+##17YY	800
		DW-BLACK				49DW40JLT317YY	50DW40JLT317YY	470
		DW-RED				49DW40JRT317YY	50DW40JRT317YY	650



# DURABLE SUPERIOR CASTERS®

49/50 – MOMENTUM™ – PRECISION TAPERED RACEWAY SERIES – 2,000 LB

Wheel Diameter	Thread Width	Wheel Type	Available Bearing Options	+ Color	Replace + with a desired wheel color. Replace # with desired wheel bearing.		Load Capacity	
					49 Series Swivel Caster Part #	50 Series Rigid Caster Part #		
4	2	DW-BLUE				49DW40JB#317YY	50DW40JB#317YY	960
		DW-GRAY				49DW40JGT#317YY	50DW40JGT#317YY	1000
		POLY-PRO™	04, 09, 60, 63, 48, 57	D, K, M, U, W		49PP40J+##17YY	50PP40J+##17YY	500
						49PP40JP#4917YY	50PP40JP#4917YY	600
		POLYMAC™	04, 09, 60, 63, 48, 57	I, M		49PM40J+##17YY	50PM40J+##17YY	600
		POLYON™	04, 09, 60	G, V		49PU40J+##17YY	50PU40J+##17YY	800
						49PU40JV#6317YY	50PU40JV#6317YY	800
		ENERGY SAVER POLYON™	04, 09, 60, 73			49SW40JU##17YY	50SW40JU##17YY	800
		POLYFLEXON™ CAST	04, 09, 60, 63, 48, 57			49RP40JK##17YY	50RP40JK##17YY	700
		POLYFLEXON™		N, O		49UA40J+6417YY	50UA40J+6417YY	900
		D-POLYON				49UD40JL#6417YY	50UD40JL#6417YY	900
		ULTRAFLEX™				49UX40J#06417YY	50UX40J#06417YY	900
		DURALASTOMER™	09, 60, 57			49SU40JL##17YY	50SU40JL##17YY	750
		SUPER ELASTOMER				49EE40J#16017YY	50EE40J#16017YY	1200
		ERGOLASTOMER™	04, 09, 73, 64, 57			49HU40J#117YY	50HU40J#117YY	1000
		SEMI-STEEL	04, 09			49SS40JS##17YY	50SS40JS##17YY	700
		HEAVY DUTY IRON	04, 09, 63			49HS40JS##17YY	50HS40JS##17YY	900
		DUCTILE	04, 09, 63, 73			49DS40JR##17YY	50DS40JR##17YY	1500
		SOLID STEEL	09, B1, B5			49MS40JS##17YY	50MS40JS##17YY	2500
		ENERGY SAVER DUCTILE™	04, 09, B1, B5			49CD40JR##17YY	50CD40JR##17YY	1500
		MAXROK™ V-GROOVE	04, 09, 60, 57			49MV40JT##17YY	50MV40JT##17YY	800
		IRON V-GROOVE	04, 09			49VG40JT##17YY	50VG40JT##17YY	600
		DUCTILE V-GROOVE	04, 09, B1, B5			49DV40JT##17YY	50DV40JT##17YY	1500
5	2	YOKE ONLY				49Z250JZ#8317YY	50Z250JZ#8317YY	
		NEO-ENERGIZER™	04, 09, 60			49EN50JB##17YY	50EN50JB##17YY	550
		NOMADIC™	04, 09, 48, 60, 57	B, I		49NM50J+##17YY	50NM50J+##17YY	500
		RUBBER ON NYLON	04, 09, 48, 60, 57			49NR50JB##17YY	50NR50JB##17YY	450
		RUBBER ON ALUMINUM	04, 09, 48, 60, 57			49RA50JB##17YY	50RA50JB##17YY	500
		MOLD-ON RUBBER	04, 09, 60, 48, 57			49RS50JB##17YY	50RS50JB##17YY	400
		CUSHENDURE™				49GR50JB#1917YY	50GR50JB#1917YY	400
		THERMO-PRO™	04, 09, 60, 48, 63, 57	A, I, T, X, Y, Z		49TP50J+##17YY	50TP50J+##17YY	350
		POLYOLEFIN		B, E		49PO50J+##17YY	50PO50J+##17YY	650
		NYLON	04, 09, 60, 48, 53, P3, 57			49NY50JE##17YY	50NY50JE##17YY	900
		IRONMAN	65, 73			49NX50JB##17YY	50NX50JB##17YY	2200
		ROKHARD™	04, 09, 48, 60, 57			49HI50JB##17YY	50HI50JB##17YY	900
		BRIMSTONE®	04, 09, 60, 90			49GN50JQ##17YY	50GN50JQ##17YY	1000
		EPOXY	04, 09, 90			49OV50JQ##17YY	50OV50JQ##17YY	1000
		MAXROK™	04, 09, 60, 48, 57			49MA50JB##17YY	50MA50JB##17YY	1000
		PHENOLIC	04, 09, 60, 48, 57, 90			49PH50JB##17YY	50PH50JB##17YY	1000
		H-TEMP PHENOLIC	04, 09, 90			49HT50JQ##17YY	50HT50JQ##17YY	750
		STEROLLIZER™				49SL50JCB#817YY	50SL50JCB#817YY	450
		POLYON MAXROK™	04, 09, 48, 60, 57	G, K		49MU50J+##17YY	50MU50J+##17YY	1000
		POLYON AL™	04, 09, 48, 60, 57	N, R		49PA50J+##17YY	50PA50J+##17YY	900
		POLYON - C	04, 09, 48, 60, 57, 12			49PR50JL##17YY	50PR50JL##17YY	900
		DW-BLACK				49DW50JLT#317YY	50DW50JLT#317YY	550
		DW-RED				49DW50JRT#317YY	50DW50JRT#317YY	750
		DW-BLUE				49DW50JBT#317YY	50DW50JBT#317YY	1160
		DW-GRAY				49DW50JGT#317YY	50DW50JGT#317YY	1200
		POLY-PRO™	04, 09, 48, 60, 63, 57	B, C, D, K, U, M, W		49PP50J+##17YY	50PP50J+##17YY	600
						49PP50JP#4917YY	50PP50JP#4917YY	700
						49PP50JH#6317YY	50PP50JH#6317YY	
		POLYMAC™	04, 09, 48, 60, 63, 57	I, M		49PM50J+##17YY	50PM50J+##17YY	750
		POLYON™				49PU50JV#6317YY	50PU50JV#6317YY	1100
			04, 09, 60, 48	G, V		49PU50J+##17YY	50PU50J+##17YY	1100
		ENERGY SAVER POLYON™	04, 09, 60, 48			49SW50JU##17YY	50SW50JU##17YY	1300
		POLYFLEXON™ CAST	04, 09, 60, 48			49RP50JK##17YY	50RP50JK##17YY	800
		POLYFLEXON™		N, O		49UA50J+6417YY	50UA50J+6417YY	900
		D-POLYON				49UD50JL#6417YY	50UD50JL#6417YY	900
		ULTRAFLEX™				49UX50J#06417YY	50UX50J#06417YY	900
		DURALASTOMER™	09, 60, 57			49SU50JL##17YY	50SU50JL##17YY	900
		SUPER ELASTOMER				49EE60J#16017YY	50EE60J#16017YY	1200
		ERGOLASTOMER™	04, 09, 73, 64, 57			49HU50J#117YY	50HU50J#117YY	1400
		SEMI-STEEL	04, 09			49SS50JS##17YY	50SS50JS##17YY	1000
		HEAVY DUTY IRON	04, 09, 63			49HS50JS##17YY	50HS50JS##17YY	1200
		DUCTILE	04, 09, 73, 63, B1, B5			49DS50JR##17YY	50DS50JR##17YY	1500
		FORGED STEEL	04, 09, B5, B1			49FS50JS##17YY	50FS50JS##17YY	2500
		ENERGY SAVER DUCTILE™	04, 09, B1, B5			49CD50JR##17YY	50CD50JR##17YY	1500
		IRON V-GROOVE	04, 09			49VG50JT##17YY	50VG50JT##17YY	900



49/50 – MOMENTUM™ – PRECISION TAPERED RACEWAY SERIES – 2,000 LB

Wheel Diameter	Thread Width	Wheel Type	Available Bearing Options	+ Color	Replace + with a desired wheel color. Replace ## with desired wheel bearing.		Load Capacity	
					49 Series Swivel Caster Part #	50 Series Rigid Caster Part #		
6	2	YOKE ONLY				49Z260JZ8317YY	50Z260JZ8317YY	
		NEO-ENERGIZER™	04, 09, 60		49EN60JB##17YY	50EN60JB##17YY	600	
		PNEUMATIC			49FP60JB6017YY	50FP60JB6017YY	200	
		FOAM FILLED			49FF60JB6017YY	50FF60JB6017YY	200	
6	2	EVER-ROLL™			B, I	49ER60J+6017YY	50ER60J+6017YY	200
		NOMADIC™	04, 09, 48, 60, 57			49NM60JB##17YY	50NM60JB##17YY	600
		RUBBER ON NYLON	04, 09, 48, 60, 57			49NR60JB##17YY	50NR60JB##17YY	550
		DURA-CUSHION™	04, 09, 63		X, Z	49BC60J+##17YY	50BC60J+##17YY	350
		ECO-RUBBER	53, P3			49SN60JC##17YY	50SN60JC##17YY	350
		RUBBER ON ALUMINUM	04, 09, 48, 60, 57			49RA60JB##17YY	50RA60JB##17YY	550
		LOW PROFILE RUBBER				49LP60JB0417YY	50LP60JB0417YY	600
		MOLD-ON RUBBER	04, 09, 48, 60, 57			49RS60JB##19Y	50RS60JB##19Y	550
		SUPREME RUBBER	63, 73			49RH60JS##17YY	50RH60JS##17YY	700
		THERMO-PRO™	04, 09, 60, 63, 48, 57		A, I, T, X, Y, Z	49TP60J+##17YY	50TP60J+##17YY	500
		POLYOLEFIN	04, 09, 60, 53, P3, 48, 57		B, E	49P060J+##17YY	50P060J+##17YY	700
		NYLON	04, 09, 48, 60, 57			49NY60JE##17YY	50NY60JE##17YY	1000
		IRONMAN	65, 73			49NX60JB##17YY	50NX60JB##17YY	2000
		ROKHARD™	04, 09, 48, 60, 57			49HI60JB##17YY	50HI60JB##17YY	1000
		BRIMSTONE®	04, 09, 60, 90			49GN60JQ##17YY	50GN60JQ##17YY	1100
		EPOXY	04, 09, 90			49OV60JQ##17YY	50OV60JQ##17YY	1100
		MAXROK™	04, 09, 60, 48, 57			49MA60JB##17YY	50MA60JB##17YY	1200
		PHENOLIC	04, 09, 60, 48, 57			49PH60JB##17YY	50PH60JB##17YY	1200
		PHENOLIC (STRAIGHT SIDED)				49PH60TB##17YY	50PH60TB##17YY	1500
		HIGH-TEMP PHENOLIC	04, 09, 90			49HT60JQ##17YY	50HT60JQ##17YY	1000
		POLY MAXROK™	04, 09, 60, 48, 57		G, K	49MU60J+##17YY	50MU60J+##17YY	1100
		POLYON AL™	04, 09, 48, 60, 57		N, R	49PA60J+##17YY	50PA60J+##17YY	1100
		POLYON-C	04, 09, 48, 60, 57, 12			49PR60JL##17YY	50PR60JL##17YY	1200
		DW-BLACK				49DW60JLT317YY	50DW60JLT317YY	700
		DW-RED				49DW60JRT317YY	50DW60JRT317YY	960
		DW-BLUE				49DW60JBT317YY	50DW60JBT317YY	1400
		DW-GRAY				49DW60JGT317YY	50DW60JGT317YY	1400
		POLY-PRO™	04, 09, 48, 60, 57		D, I, K, M, W, U	49PP60J+##17YY	50PP60J+##17YY	720
						49PP60JP4917YY	50PP60JP4917YY	900
		POLYMAX™	04, 09, 48, 60, 63, 57		I, M	49PP60JH6317YY	50PP60JH6317YY	900
						49PM60J+##17YY	50PM60J+##17YY	900
		POLYON™	04, 09, 60		G, V	49PU60JV6317YY	50PU60JV6317YY	1200
						49PU60J+##17YY	50PU60J+##17YY	1200
		ENERGY SAVER POLYON™	04, 09, 63, 73			49SW60JU##17YY	50SW60JU##17YY	1400
		POLYFLEXON™ CAST	04, 09, 60, 48, 57			49RP60JK##17YY	50RP60JK##17YY	900
		POLYFLEXON™			N, O	49UA60J+6417YY	50UA60J+6417YY	1000
		D-POLYON				49UD60JL6417YY	50UD60JL6417YY	1000
		ULTRAFLEX™				49UX60JO6417YY	50UX60JO6417YY	1000
		CHAMPION				49CP60JN6417YY	50CP60JN6417YY	1200
		DURALASTOMER™	09, 60, 57			49SU60JL##17YY	50SU60JL##17YY	1000
		SUPER ELASTOMER				49EE60JI6017YY	50EE60JI6017YY	1320
		ERGOLASTOMER™	04, 09, 73, 64, 57			49HU60JI##17YY	50HU60JI##17YY	1700
		SEMI-STEEL	04, 09			49SS60JS##17YY	50SS60JS##17YY	1200
HEAVY DUTY IRON	04, 09, 63			49HS60JS##17YY	50HS60JS##17YY	1400		
DUCTILE	04, 09, 73, 63, B1, B5			49DS60JR##17YY	50DS60JR##17YY	2000		
ENERGY SAVER DUCTILE™	04, 09, B1, B5			49CD60JR##17YY	50CD60JR##17YY	2000		
FORGED STEEL	04, 09, 73, 63, B1, B5			49FS60JS##17YY	50FS60JS##17YY	2500		
IRON V-GROOVE	04, 09			49VG60JT##17YY	50VG60JT##17YY	1000		
DUCTILE V-GROOVE	04, 09, B1, B5			49DV60JT##17YY	50DV60JT##17YY	1500		
8	2	YOKE ONLY				49Z280JZ8317YY	50Z280JZ8317YY	
		NEO-ENERGIZER™	04, 09, 60			49EN80JB##17YY	50EN80JB##17YY	600
		NOMADIC™	04, 09, 48, 60, 57		B, I	49NM80J+##17YY	50NM80J+##17YY	700
		RUBBER ON NYLON	04, 09, 48, 60, 57			49NR80JB##17YY	50NR80JB##17YY	600
		DURA-CUSHION™	04, 09, 63		X, Z	49BC80J+##17YY	50BC80J+##17YY	450
		ECO-RUBBER	53, P3			49SN80UC##17YY	50SN80UC##17YY	450
		RUBBER ON ALUMINUM	04, 09, 48, 60, 57			49RA80JB##17YY	50RA80JB##17YY	600
		MOLD-ON RUBBER	04, 09, 48, 60, 57			49RS80JB##17YY	50RS80JB##17YY	600
		SUPREME RUBBER	63, 73			49RH80JS##17YY	50RH80JS##17YY	800
		THERMO-PRO™	04, 09, 60, 63, 48, 57		A, I, T, X, Y, Z,	49TP80J+##17YY	50TP80J+##17YY	600
		POLYOLEFIN	04, 09, 60, 53, P3, 48, 57, 90		B, E	49P080J+##17YY	50P080J+##17YY	900
		NYLON	04, 09, 60, 48, 57			49NY80JE##17YY	50NY80JE##17YY	1100
		IRONMAN	65, 73			49NX80JB##17YY	50NX80JB##17YY	2200
		ROKHARD™	04, 09, 48, 60, 57			49HI80JB##17YY	50HI80JB##17YY	1100
		BRIMSTONE®	04, 09, 60, 90			49GN80JQ##17YY	50GN80JQ##17YY	1200



# DURABLE SUPERIOR CASTERS®

49/50 – MOMENTUM™ – PRECISION TAPERED RACEWAY SERIES – 2,000 LB

Wheel Diameter	Thread Width	Wheel Type	Available Bearing Options	+ Color	Replace + with a desired wheel color. Replace # with desired wheel bearing.		Load Capacity	
					49 Series Swivel Caster Part #	50 Series Rigid Caster Part #		
8	2	EPOXY	04, 09, 90			49OV80JQ##17YY	50OV80JQ##17YY	1200
		MAXROK™	04, 09, 48, 60, 57			49MA80JB##17YY	50MA80JB##17YY	1400
		PHENOLIC	04, 09, 60, 57			49PH80JB##17YY	50PH80JB##17YY	1400
		HIGH-TEMP PHENOLIC	04, 09, 60, 90			49HT80JQ##17YY	50HT80JQ##17YY	1100
		POLY MAXROK™	04, 09, 48, 60, 57	G, K		49MU80J+##17YY	50MU80J+##17YY	1400
		POLYON AL™	04, 09, 48, 60, 57	N, R		49PA80J+##17YY	50PA80J+##17YY	1500
		DW-BLACK				49DW80JLT317YY	50DW80JLT317YY	750
		DW-RED				49DW80JRT317YY	50DW80JRT317YY	1100
		DW-BLUE				49DW80JBT317YY	50DW80JBT317YY	1600
		DW-GRAY				49DW80JGT317YY	50DW80JGT317YY	1700
		POLY-PRO™	04, 09, 48, 60, 63, 57		C, D, I, K, M, U, W	49PP80J+##17YY	50PP80J+##17YY	800
						49PP80JP4917YY	50PP80JP4917YY	900
		POLYMADIC™	04, 09, 48, 60, 63, 57		I, M	49PP80JH6317YY	50PP80JH6317YY	1000
						49PM80J+##17YY	50PM80J+##17YY	1000
		POLYON™	04, 09, 60		G, V	49PU80JV6317YY	50PU80JV6317YY	1400
						49PU80J+##17YY	50PU80J+##17YY	
		ENERGY SAVER POLYON™	04, 09, 60			49SW80JU##17YY	50SW80JU##17YY	1500
		POLYFLEXON™ CAST				49RP80JK6317YY	50RP80JK6317YY	1000
		POLYFLEXON™			N, O	49UA80J+6417YY	50UA80J+6417YY	1200
		D-POLYON				49UD80JL6417YY	50UD80JL6417YY	1200
		ULTRAFLEX™				49UX80JO6417YY	50UX80JO6417YY	1200
		CHAMPION				49CP80JN6417YY	50CP80JN6417YY	1500
		DURALASTOMER™	09, 60, 63, 57			49SU80JL##17YY	50SU80JL##17YY	1000
		SUPER ELASTOMER				49EE80JI6017YY	50EE80JI6017YY	1250
		ERGOLASTOMER™	04, 09, 73, 64, 57			49HU80JI##17YY	50HU80JI##17YY	2000
		SEMI-STEEL	04, 09			49SS80JS##17YY	50SS80JS##17YY	1400
		HEAVY DUTY IRON	04, 09, 63			49HS80JS##17YY	50HS80JS##17YY	1600
		DUCTILE	04, 09, 63, 73, B1, B5			49DS80JR##17YY	50DS80JR##17YY	2000
		ENERGY SAVER DUCTILE™	04, 09, B1, B5			49CD80JR##17YY	50CD80JR##17YY	2000
		FORGED STEEL	04, 09, 73, 63, B5, B1			49FS80JS##17YY	50FS80JS##17YY	2500
		IRON V-GROOVE	04, 09			49VG80JT##17YY	50VG80JT##17YY	1200



## CP – CHAMPION™

Specially engineered Polyurethane for Best Ergonomic Performance. The Shore "A" 75, 1-3/8" thick tread provides the best protection to cargo. *Please find page 141 for more information.*



## UX – SUPER ELASTOMER (ULTRAFLEX™)

A newly innovated polyurethane compound provides this wheel with a high rebound strength. Unparalleled memory rebound after set, donut shaped tread design improves its ergonomic performance when the equipment is at turning point. *For more information, please find page 145.*



**41, 45, 4A, 46 – MEDIUM HEAVY DUTY KINGPINLESS SERIES – 2,500 LB**

**NEW**



FASTENING PATTERN			
Plate Code	Overall Size	Bolt Hole Pattern	Mounting Bolt Size
17	4 X 4-1/2	2-5/8 X 3-5/8 TO 3 X 3	3/8
A7	3-53/64 X 4-13/32	2-5/8 X 3-5/8 TO 3 X 3	
19	4-1/2 X 6-1/4	2-7/16 X 4-15/16 TO 3-3/8 X 5-1/4	

WHEEL DIAMETER, OVERALL HEIGHT AND OFFSETS							
Wheel Diameter	Designation Code*	Overall Height			Offset		
		41 Series	45 Series	4A Series	41 Series	45 Series	4A Series
4	40	5-5.8	5-5/8	5-5/8	1-1/4	1-1/8	1-1/4
	45				3		
5	50	6-1/2	6-1/2	6-1/2	1-3/8	1-1/4	1-3/8
6	60	7-1/2	7-1/2	7-1/2	1-9/16	1-1/2	1-9/16
6	65		7-1/2			2	
6	66	7-1.2	7-1/2		2-1/2	2-1/2	
8	80	9-1/2	9-1/2	9-1/2	2	2	1-15/16
8	85	9-1/2	9-1/2		3-1/2	3-1/2	
8	81		10-1/8			2-1/8	
8	89	10-1/8	10-1/8		3-1/2	3-1/2	

\*To order, replace the standard wheel diameter designation with optional code. (Example: 45UA85JN6317YY)

- Precisely CNC machined raceway with harden ball bearings
- 1/4" thick top plate with legs formed from 1/4" steel
- Designed for ultimate solution of traditional casters with kingpin being loosened from lateral force
- Bright zinc-plated as standard
- Extended swivel radius for better maneuverability is available for 6" and 8"
- **Each series are designed for the efficiency to satisfy different applications:**
  - **#41** has load capacity up to 1,500 lb raceway is made of hardened ASTM1045, with weld on inner raceway
  - **#4A** has load capacity up to 1,500 lb It is specially designed for environment that require sealed raceway. Raceway is made of hardened ASTM1045, with weld on inner raceway. Varieties of seals that can handle temperature up to 450°F
  - **#45** is the ultimate of kingpinless casters and has load capacity up to 2,500 lb. It is made of hot forged ASTM1045 for the highest density and hardened for durability. The inner raceway is forged integrally with the top plate

BEARING CHART (##)								
Bearing Code	Description	Wheel Width	Bearing Code	Description	Wheel Width	Bearing Code	Description	Wheel Width
88	PLAIN 3/4" ID	1.5 & 2	49	PRECISION BEARING INTEGRATED W/ TOP HEAD	2	11	SOLID DELRIN BEARING	1.5
03	ROLLER W/ OUTER SPLIT	1.5				12	SOLID DELRIN BEARING	2
04	ROLLER W/ OUTER SPLIT	2				57	FLANGED DELRIN BEARING	1.5 & 2
09	CAGED ROLLER BEARINGS	2	60	FLANGED PRECISION BALL BEARING	1.5 & 2	53	FLANGED BALL BEARING	1.5 & 2
48	DUAL-ROLL CAGED BALL BEARING	2	B1	1-PC BRONZE BUSHING	2	B5	FLANGED BRONZE BUSHING	2
73	PRECISION TAPERED BEARING	2						

BRAKE OPTIONS		
Top Lock Brake (T)	A-Cam Brake (A)	Cam-Lock Brake (C)

OTHER OPTIONS				
4-Position Lock (P)	Thread Guards (G)	4-Position Lock Bolt-on. Order Separately Part # 4PSL27	Toe Guard	Foot Engage



# DURABLE SUPERIOR CASTERS®

41, 45, 4A, 46 – MEDIUM HEAVY DUTY KINGPINLESS SERIES – 2,500 LB

Wheel Dia.	Thread Width	Wheel Type	Available Bearing Options	+ Color	Replace + with a desired wheel color. Replace # with desired wheel bearing.						
					41 Series Part #	4A Series Part #	Load Cap.	45 Series Part #	Load Cap.	46 Series Part #	
4	2	YOKE ONLY				41ZZ40JZ8317YY	4AZZ40JZ8317YY		45ZZ40JZ8317YY		46ZZ40JZ8317YY
		ENERGIZER™	04, 09, 60		41EN40JB##17YY	4AEN40JB##17YY	500	45EN40JB##17YY	500	46EN40JB##17YY	
		NOMADIC™	04, 09, 60, 48, 57	I, B	41NM40J+##17YY	4ANM40J+##17YY	400	45NM40J+##17YY	400	46NM40J+##17YY	
		RUBBER ON NYLON	04, 09, 60, 48, 57		41NR40JB##17YY	4ANR40JB##17YY	400	45NR40JB##17YY	400	46NR40JB##17YY	
		RUBBER ON ALUMINUM	04, 09, 60, 48, 57		41RA40JB##17YY	4ARA40JB##17YY	400	45RA40JB##17YY	400	46RA40JB##17YY	
		LOW PROFILE RUBBER			41LP40JB0417YY	4ALP40JB04A7YY	300	45LP40JB0417YY	300	46LP40JB0417YY	
		MOLD-ON RUBBER	04, 09, 60, 48, 57		41RS40JB##17YY	4ARS40JB##17YY	400	45RS40JB##17YY	400	46RS40JB##17YY	
		THERMO-PRO™	04, 09, 60, 63, 48, 57	A, T, Y	41TP40J+##17YY	4ATP40J+##17YY	300	45TP40J+##17YY	300	46TP40J+##17YY	
		POLYOLEFIN	04, 09, 60, 63, 48, 57	B, E	41PO40J+##17YY	4APO40J+##17YY	500	45PO40J+##17YY	500	46PO40J+##17YY	
		NYLON	04, 09, 60, 63, 48, 57		41NY40JE##17YY	4ANY40JE##17YY	800	45NY40JE##17YY	800	46NY40JE##17YY	
		IRONMAN	04, 09, 65, 73		41NX40JB##17YY	4ANX40JB##17YY	1500	45NX40JB##17YY	2200	46NX40JB##17YY	
		ROKHARD™	04, 09, 60, 63, 48, 57		41HI40JB##17YY	4AHI40JB##17YY	800	45HI40JB##17YY	800	46HI40JB##17YY	
		BRIMSTONE®	04, 09, 90		41GN40JQ##17YY	4AGN40JQ##17YY	800	45GN40JQ##17YY	800	46GN40JQ##17YY	
		EPOXY	04, 09, 90		41OV40JQ##17YY	4AOV40JQ##17YY	800	45OV40JQ##17YY	800	46OV40JQ##17YY	
		MAXROK™	04, 09, 60, 63, 48, 57		41MA40JB##17YY	4AMA40JB##17YY	800	45MA40JB##17YY	800	46MA40JB##17YY	
		PHENOLIC	04, 09, 60, 63, 48, 57		41PH40JB##17YY	4APH40JB##17YY	800	45PH40JB##17YY	800	46PH40JB##17YY	
		PHENOLIC (STRAIGHT SIDED)	04, 09, 60, 57, 12		41PH40TB##17YY	4APH40TB##17YY	1000	45PH40TB##17YY	1000	46PH40TB##17YY	
		HIGH-TEMP PHENOLIC	04, 09, 90		41HT40JQ##17YY	4AHT40JQ##17YY	600	45HT40JQ##17YY	600	46HT40JQ##17YY	
		POLYON MAXROK™	04, 09, 60, 63, 48, 57	G, K	41MU40J+##17YY	4AMU40J+##17YY	700	45MU40J+##17YY	700	46MU40J+##17YY	
		POLY AL™	04, 09, 60, 63, 48, 57	N, R	41PA40J+##17YY	4APA40J+##17YY	800	45PA40J+##17YY	800	46PA40J+##17YY	
		DW -BLACK			41DW40JLT317YY	4ADW40JLT317YY	470	45DW40JLT317YY	470	46DW40JLT317YY	
		DW-RED			41DW40JRT317YY	4ADW40JRT317YY	650	45DW40JRT317YY	650	46DW40JRT317YY	
		DW-BLUE			41DW40JBT317YY	4ADW40JBT317YY	960	45DW40JBT317YY	960	46DW40JBT317YY	
		DW-GRAY			41DW40JGT317YY	4ADW40JGT317YY	1000	45DW40JGT317YY	1000	46DW40JGT317YY	
		POLY-PRO™	04, 09, 60, 63, 48, 57	D, K, M, U, W	41PP40J+##17YY	4APP40J+##17YY	500	45PP40J+##17YY	500	46PP40J+##17YY	
					41PP40JP4917YY	4APP40JP4917YY	600	45PP40JP4917YY	600	46PP40JP4917YY	
		POLYADIC™	04, 09, 60, 63, 48, 57	I, M	41PM40J+##17YY	4APM40J+##17YY	600	45PM40J+##17YY	600	46PM40J+##17YY	
		POLYON™	04, 09, 60	G, V	41PU40J+##17YY	4APU40J+##17YY	800	45PU40J+##17YY	800	46PU40J+##17YY	
					41PU40JV6317YY	4APU40JV6317YY	800	45PU40JV6317YY	800	46PU40JV6317YY	
		ENERGY SAVER POLYON™	04, 09, 60, 73		41SW40JU##17YY	4ASW40JU##17YY	800	45SW40JU##17YY	800	46SW40JU##17YY	
		POLYFLEXON™ CAST	04, 09, 60, 63, 48, 57		41RP40JK##17YY	4ARP40JK##17YY	700	45RP40JK##17YY	700	46RP40JK##17YY	
		POLYFLEXON™		N, O	41UA40J+6417YY	4AUA40J+64A7YY	900	45UA40J+6417YY	900	46UA40J+6417YY	
		D-POLYON			41UD40JL6417YY	4AUD40JL64A7YY	900	45UD40JL6417YY	900	46UD40JL6417YY	
		ULTRAFLEX™			41UX40J06417YY	4AUX40J06417YY	900	45UX40J06417YY	900	46UX40J06417YY	
		DURALASTOMER™	09, 60, 57		41SU40JL##17YY	4ASU40JL##17YY	750	45SU40JL##17YY	750	46SU40JL##17YY	
		SUPER ELASTOMER			41EE40J16017YY	4AEE40J16017YY	1200	45EE40J16017YY	1200	46EE40J16017YY	
		ERGOLASTOMER™	04, 09, 73, 64, 57		41HU40JI##17YY	4AHU40JI##17YY	1000	45HU40JI##17YY	1000	46HU40JI##17YY	
		SEMI-STEEL	04, 09		41SS40JS##17YY	4ASS40JS##17YY	700	45SS40JS##17YY	700	46SS40JS##17YY	
		HEAVY DUTY IRON	04, 09, 63		41HS40JS##17YY	4AHS40JS##17YY	900	45HS40JS##17YY	900	46HS40JS##17YY	
		DUCTILE	04, 09, 63, 73		41DS40JR##17YY	4ADS40JR##17YY	1500	45DS40JR##17YY	1500	46DS40JR##17YY	
		SOLID STEEL	09, B1, B5		41MS40JS##17YY	4AMS40JS##17YY	1500	45MS40JS##17YY	2500	46MS40JS##17YY	
		ENERGY SAVER DUCTILE™	04, 09, B1, B5		41CD40JR##17YY	4ACD40JR##17YY	1500	45CD40JR##17YY	1500	46CD40JR##17YY	
		MAXROK™ V-GROOVE	04, 09, 60, 57		41MV40JT##17YY	4AMV40JT##17YY	800	45MV40JT##17YY	800	46MV40JT##17YY	
		IRON V-GROOVE	04, 09		41VG40JT##17YY	4AVG40JT##17YY	600	45VG40JT##17YY	600	46VG40JT##17YY	
		DUCTILE V-GROOVE	04, 09, B1, B5		41DV40JT##17YY	4ADV40JT##17YY	1500	45DV40JT##17YY	1500	46DV40JT##17YY	
5	2	YOKE ONLY				41ZZ50JZ8317YY	4AZZ50JZ8317YY		45ZZ50JZ8317YY		46ZZ50JZ8317YY
		ENERGIZER™	04, 09, 60		41EN50JB##17YY	4AEN50JB##17YY	550	45EN50JB##17YY	550	46EN50JB##17YY	
		NOMADIC™	04, 09, 48, 60, 57	B, I	41NM50J+##17YY	4ANM50J+##17YY	500	45NM50J+##17YY	500	46NM50J+##17YY	
		RUBBER ON NYLON	04, 09, 48, 60, 57		41NR50JB##17YY	4ANR50JB##17YY	450	45NR50JB##17YY	450	46NR50JB##17YY	
		RUBBER ON ALUMINUM	04, 09, 48, 60, 57		41RA50JB##17YY	4ARA50JB##17YY	500	45RA50JB##17YY	500	46RA50JB##17YY	
		MOLD-ON RUBBER	04, 09, 60, 48, 57		41RS50JB##17YY	4ARS50JB##17YY	400	45RS50JB##17YY	400	46RS50JB##17YY	
		CUSHENDURE™			41GR50JB1917YY	4AGR50JB1917YY	400	45GR50JB1917YY	400	46GR50JB1917YY	
		THERMO-PRO™	04, 09, 60, 48, 63, 57	A, I, T, X, Y, Z	41TP50J+##17YY	4ATP50J+##17YY	350	45TP50J+##17YY	350	46TP50J+##17YY	
		POLYOLEFIN		B, E	41PO50J+##17YY	4APO50J+##17YY	650	45PO50J+##17YY	650	46PO50J+##17YY	
		NYLON	04, 09, 60, 48, 53, P3, 57		41NY50JE##17YY	4ANY50JE##17YY	900	45NY50JE##17YY	900	46NY50JE##17YY	



41, 45, 4A, 46 – MEDIUM HEAVY DUTY KINGPINLESS SERIES – 2,500 LB

Wheel Dia.	Thread Width	Wheel Type	Available Bearing Options	+ Color	Replace + with a desired wheel color. Replace ## with desired wheel bearing.					
					41 Series Part #	4A Series Part #	Load Cap.	45 Series Part #	Load Cap.	46 Series Part #
5	2	IRONMAN	65, 73		41NX50JB##17YY	4ANX50JB##17YY	1500	45NX50JB##17YY	2200	46NX50JB##17YY
		ROKHARD™	04, 09, 48, 60, 57		41HI50JB##17YY	4AHI50JB##17YY	900	45HI50JB##17YY	900	46HI50JB##17YY
		BRIMSTONE®	04, 09, 60, 90		41GN50JQ##17YY	4AGN50JQ##17YY	1000	45GN50JQ##17YY	1000	46GN50JQ##17YY
		EPOXY	04, 09, 90		41OV50JQ##17YY	4AOV50JQ##17YY	1000	45OV50JQ##17YY	1000	46OV50JQ##17YY
		MAXROK™	04, 09, 60, 48, 57		41MA50JB##17YY	4AMA50JB##17YY	1000	45MA50JB##17YY	1000	46MA50JB##17YY
		PHENOLIC	04, 09, 60, 48, 57, 90		41PH50JB##17YY	4APH50JB##17YY	1000	45PH50JB##17YY	1000	46PH50JB##17YY
		H-TEMP PHENOLIC	04, 09, 90		41HT50JQ##17YY	4AHT50JQ##17YY	750	45HT50JQ##17YY	750	46HT50JQ##17YY
		STEROLLIZER™			41SL50JCB817YY	4ASL50JCB817YY	450	45SL50JCB817YY		46SL50JCB817YY
		POLYON MAXROK™	04, 09, 48, 60, 57	G, K	41MU50J+##17YY	4AMU50J+##17YY	1000	45MU50J+##17YY	1000	46MU50J+##17YY
		POLYON AL™	04, 09, 48, 60, 57	N, R	41PA50J+##17YY	4APA50J+##17YY	900	45PA50J+##17YY	900	46PA50J+##17YY
		POLYON - C	04, 09, 48, 60, 57, 12		41PR50JL##17YY	4APR50JL##17YY	900	45PR50JL##17YY	900	46PR50JL##17YY
		DW-BLACK			41DW50JLT317YY	4ADW50JLT317YY	550	45DW50JLT317YY	550	46DW50JLT317YY
		DW-RED			41DW50JRT317YY	4ADW50JRT317YY	750	45DW50JRT317YY	750	46DW50JRT317YY
		DW-BLUE			41DW50JBT317YY	4ADW50JBT317YY	1160	45DW50JBT317YY	1160	46DW50JBT317YY
		DW-GRAY			41DW50JGT317YY	4ADW50JGT317YY	1200	45DW50JGT317YY	1200	46DW50JGT317YY
		POLY-PRO™	04, 09, 48, 60, 63, 57	B, C, D, K, U, M, W	41PP50J+##17YY	4APP50J+##17YY	600	45PP50J+##17YY	600	46PP50J+##17YY
					41PP50JP4917YY	4APP50JP4917YY	700	45PP50JP4917YY	700	46PP50JP4917YY
					41PP50JH6317YY	4APP50JH6317YY		45PP50JH6317YY		46PP50JH6317YY
		POLYMAC™	04, 09, 48, 60, 63, 57	I, M	41PM50J+##17YY	4APM50J+##17YY	750	45PM50J+##17YY	750	46PM50J+##17YY
					41PU50JV6317YY	4APU50JV6317YY	1100	45PU50JV6317YY	1100	46PU50JV6317YY
		POLYON™	04, 09, 60, 48	G, V	41PU50J+##17YY	4APU50J+##17YY	1100	45PU50J+##17YY	1100	46PU50J+##17YY
					41SW50JU##17YY	4ASW50JU##17YY	1300	45SW50JU##17YY	1300	46SW50JU##17YY
		ENERGY SAVER POLYON™	04, 09, 60, 48		41SW50JU##17YY	4ASW50JU##17YY	1300	45SW50JU##17YY	1300	46SW50JU##17YY
		POLYFLEXON™ CAST	04, 09, 60, 48		41RP50JK##17YY	4ARP50JK##17YY	800	45RP50JK##17YY	800	46RP50JK##17YY
		POLYFLEXON™		N, O	41UA50J+6417YY	4AUA50J+6417YY	900	45UA50J+6417YY	900	46UA50J+6417YY
		D-POLYON			41UD50JL6417YY	4AUD50JL6417YY	900	45UD50JL6417YY	900	46UD50JL6417YY
		ULTRAFLEX™			41UX50J06417YY	4AUX50J06417YY	900	45UX50J06417YY	900	46UX50J06417YY
		DURALASTOMER™	09, 60, 57		41SU50JL##17YY	4ASU50JL##17YY	900	45SU50JL##17YY	900	46SU50JL##17YY
		SUPER ELASTOMER			41EE50JI6017YY	4AEE50JI6017YY	1200	45EE50JI6017YY	1200	46EE50JI6017YY
		ERGOLASTOMER™	04, 09, 73, 64, 57		41HU50JI##17YY	4AHU50JI##17YY	1400	45HU50JI##17YY	1400	46HU50JI##17YY
		SEMI-STEEL	04, 09		41SS50JS##17YY	4ASS50JS##17YY	1000	45SS50JS##17YY	1000	46SS50JS##17YY
		HEAVY DUTY IRON	04, 09, 63		41HS50JS##17YY	4AHS50JS##17YY	1200	45HS50JS##17YY	1200	46HS50JS##17YY
		DUCTILE	04, 09, 73, 63, B1, B5		41DS50JR##17YY	4ADS50JR##17YY	1500	45DS50JR##17YY	1500	46DS50JR##17YY
		FORGED STEEL	04, 09, B5, B1		41FS50JS##17YY	4AFS50JS##17YY	1500	45FS50JS##17YY	2500	46FS50JS##17YY
		ENERGY SAVER DUCTILE™	04, 09, B1, B5		41CD50JR##17YY	4ACD50JR##17YY	1500	45CD50JR##17YY	1500	46CD50JR##17YY
		IRON V-GROOVE	04, 09		41VG50JT##17YY	4AVG50JT##17YY	900	45VG50JT##17YY	900	46VG50JT##17YY
		YOKE ONLY			41ZZ60JZ8317YY	4AZZ60JZ8317YY		45ZZ60JZ8317YY		46ZZ60JZ8317YY
		ENERGIZER™	04, 09, 60		41EN60JB##17YY	4AEN60JB##17YY	600	45EN60JB##17YY	600	46EN60JB##17YY
		PNEUMATIC			41FP60JB6017YY	4AFP60JB6017YY	200	45FP60JB6017YY	200	46FP60JB6017YY
		FOAM FILLED			41FF60JB6017YY	4AFF60JB6017YY	200	45FF60JB6017YY	200	46FF60JB6017YY
EVER-ROLL™		B, I	41ER60J+6017YY	4AER60J+6017YY	200	45ER60J+6017YY	200	46ER60J+6017YY		
NOMADIC™	04, 09, 48, 60, 57		41NM60JB##17YY	4ANM60JB##17YY	600	45NM60JB##17YY	600	46NM60JB##17YY		
RUBBER ON NYLON	04, 09, 48, 60, 57		41NR60JB##17YY	4ANR60JB##17YY	550	45NR60JB##17YY	550	46NR60JB##17YY		
DURA-CUSHION™	04, 09, 63	X, Z	41BC60J+##17YY	4ABC60J+##17YY	350	45BC60J+##17YY	350	46BC60J+##17YY		
ECO-RUBBER	53, P3		41SN60JC##17YY	4ASN60JC##17YY	350	45SN60JC##17YY	350	46SN60JC##17YY		
RUBBER ON ALUMINUM	04, 09, 48, 60, 57		41RA60JB##17YY	4ARA60JB##17YY	550	45RA60JB##17YY	550	46RA60JB##17YY		
LOW PROFILE RUBBER			41LP60JB0417YY	4ALP60JB04A7YY	600	45LP60JB0417YY	600	46LP60JB0417YY		
MOLD-ON RUBBER	04, 09, 48, 60, 57		41RS60JB##17YY	4ARS60JB##17YY	550	45RS60JB##17YY	550	46RS60JB##17YY		
SUPREME RUBBER	63, 73		41RH60JS##17YY	4ARH60JS##17YY	700	45RH60JS##17YY	700	46RH60JS##17YY		
THERMO-PRO™	04, 09, 60, 63, 48, 57	A, I, T, X, Y, Z	41TP60J+##17YY	4ATP60J+##17YY	500	45TP60J+##17YY	500	46TP60J+##17YY		
			41PO60J+##17YY	4APO60J+##17YY	700	45PO60J+##17YY	700	46PO60J+##17YY		
POLYOLEFIN	04, 09, 60, 53, P3, 48, 57	B, E	41PO60J+##17YY	4APO60J+##17YY	700	45PO60J+##17YY	700	46PO60J+##17YY		
NYLON	04, 09, 48, 60, 57		41NY60JE##17YY	4ANY60JE##17YY	1000	45NY60JE##17YY	1000	46NY60JE##17YY		
IRONMAN	65, 73		41NX60JB##17YY	4ANX60JB##A7YY	1500	45NX60JB##17YY	2200	46NX60JB##17YY		
ROKHARD™	04, 09, 48, 60, 57		41HI60JB##17YY	4AHI60JB##17YY	1000	45HI60JB##17YY	1000	46HI60JB##17YY		
BRIMSTONE®	04, 09, 60, 90		41GN60JQ##17YY	4AGN60JQ##17YY	1100	45GN60JQ##17YY	1100	46GN60JQ##17YY		
EPOXY	04, 09, 90		41OV60JQ##17YY	4AOV60JQ##17YY	1100	45OV60JQ##17YY	1100	46OV60JQ##17YY		
MAXROK™	04, 09, 60, 48, 57		41MA60JB##17YY	4AMA60JB##17YY	1200	45MA60JB##17YY	1200	46MA60JB##17YY		
PHENOLIC	04, 09, 60, 48, 57		41PH60JB##17YY	4APH60JB##17YY	1200	45PH60JB##17YY	1200	46PH60JB##17YY		
PHENOLIC (STRAIGHT SIDED)			41PH60TB##17YY	4APH60TB##17YY	1500	45PH60TB##17YY	1500	46PH60TB##17YY		
HIGH-TEMP PHENOLIC	04, 09, 90		41HT60JQ##17YY	4AHT60JQ##17YY	1000	45HT60JQ##17YY	1000	46HT60JQ##17YY		
POLY MAXROK™	04, 09, 60, 48, 57	G, K	41MU60J+##17YY	4AMU60J+##17YY	1100	45MU60J+##17YY	1100	46MU60J+##17YY		
POLYON AL™	04, 09, 48, 60, 57	N, R	41PA60J+##17YY	4APA60J+##17YY	1100	45PA60J+##17YY	1100	46PA60J+##17YY		



# DURABLE SUPERIOR CASTERS®

41, 45, 4A, 46 – MEDIUM HEAVY DUTY KINGPINLESS SERIES – 2,500 LB

Wheel Dia.	Thread Width	Wheel Type	Available Bearing Options	+ Color	Replace + with a desired wheel color. Replace # with desired wheel bearing.						
					41 Series Part #	4A Series Part #	Load Cap.	45 Series Part #	Load Cap.	46 Series Part #	
6	2	POLYON-C	04, 09, 48, 60, 57, 12		41PR60JL##17YY	4APR60JL##17YY	1200	45PR60JL##17YY	1200	46PR60JL##17YY	
		DW-BLACK			41DW60JLT317YY	4ADW60JLT317YY	700	45DW60JLT317YY	700	46DW60JLT317YY	
		DW-RED			41DW60JRT317YY	4ADW60JRT317YY	900	45DW60JRT317YY	900	46DW60JRT317YY	
		DW-BLUE			41DW60JBT317YY	4ADW60JBT317YY	1400	45DW60JBT317YY	1400	46DW60JBT317YY	
		DW-GRAY			41DW60JGT317YY	4ADW60JGT317YY	1440	45DW60JGT317YY	1440	46DW60JGT317YY	
		POLY-PRO™	04, 09, 48, 60, 57	D, I, K, M, W, U		41PP60J##17YY	4APP60J##17YY	720	45PP60J##17YY	720	46PP60J##17YY
						41PP60JP4917YY	4APP60JP4917YY	900	45PP60JP4917YY	900	46PP60JP4917YY
						41PP60JH6317YY	4APP60JH6317YY		45PP60JH6317YY		46PP60JH6317YY
		POLYMAC™	04, 09, 48, 60, 63, 57	I, M		41PM60J##17YY	4APM60J##17YY	900	45PM60J##17YY	900	46PM60J##17YY
		POLYON™	04, 09, 60	G, V		41PU60JV6317YY	4APU60JV6317YY	1200	45PU60JV6317YY	1200	46PU60JV6317YY
		ENERGY SAVER POLYON™	04, 09, 63, 73			41SW60JU##17YY	4ASW60JU##17YY	1400	45SW60JU##17YY	1400	46SW60JU##17YY
		POLYFLEXON™ CAST	04, 09, 60, 48, 57			41RP60JK##17YY	4ARP60JK##17YY	900	45RP60JK##17YY	900	46RP60JK##17YY
		POLYFLEXON™		N, O		41UA60J+6417YY	4AUA60J+6417YY	1000	45UA60J+6417YY	1000	46UA60J+6417YY
		D-POLYON				41UD60JL6417YY	4AUD60JL6417YY	1000	45UD60JL6417YY	1000	46UD60JL6417YY
		ULTRAFLEX™				41UX60JO6417YY	4AUX60JO6417YY	1000	45UX60JO6417YY	1000	46UX60JO6417YY
		CHAMPION				41CP60JN6417YY	4ACP60JN6417YY	1200	45CP60JN6417YY	1200	46CP60JN6417YY
		DURALASTOMER™	09, 60, 57			41SU60JL##17YY	4ASU60JL##17YY	1000	45SU60JL##17YY	1000	46SU60JL##17YY
		SUPER ELASTOMER				41EE60JI6017YY	4AEE60JI6017YY	1320	45EE60JI6017YY	1320	46EE60JI6017YY
		ERGOLASTOMER™	04, 09, 73, 64, 57			41HU60JI##17YY	4AHU60JI##17YY	1500	45HU60JI##17YY	1700	46HU60JI##17YY
		SEMI-STEEL	04, 09			41SS60JS##17YY	4ASS60JS##17YY	1200	45SS60JS##17YY	1200	46SS60JS##17YY
		HEAVY DUTY IRON	04, 09, 63			41HS60JS##17YY	4AHS60JS##17YY	1400	45HS60JS##17YY	1400	46HS60JS##17YY
		DUCTILE	04, 09, 73, 63, B1, B5			41DS60JR##17YY	4ADS60JR##17YY	1500	45DS60JR##17YY	2000	46DS60JR##17YY
		ENERGY SAVER DUCTILE™	04, 09, B1, B5			41CD60JR##17YY	4ACD60JR##17YY	1500	45CD60JR##17YY	2000	46CD60JR##17YY
		FORGED STEEL	04, 09, 73, 63, B1, B5			41FS60JS##17YY	4AFS60JS##17YY	1500	45FS60JS##17YY	2500	46FS60JS##17YY
		IRON V-GROOVE	04, 09			41VG60JT##17YY	4AVG60JT##17YY	1000	45VG60JT##17YY	1000	46VG60JT##17YY
		DUCTILE V-GROOVE	04, 09, B1, B5			41DV60JT##17YY	4ADV60JT##17YY	1500	45DV60JT##17YY	1500	46DV60JT##17YY
		YOKO ONLY				41ZZ80JZ8317YY	4AZZ80JZ8317YY		45ZZ80JZ8317YY		46ZZ80JZ8317YY
		ENERGIZER™	04, 09, 60			41EN80JB##17YY	4AEN80JB##17YY	600	45EN80JB##17YY	600	46EN80JB##17YY
		NOMADIC™	04, 09, 48, 60, 57	B, I		41NM80J##17YY	4ANM80J##17YY	700	45NM80J##17YY	700	46NM80J##17YY
		RUBBER ON NYLON	04, 09, 48, 60, 57			41NR80JB##17YY	4ANR80JB##17YY	600	45NR80JB##17YY	600	46NR80JB##17YY
DURA-CUSHION™	04, 09, 63	X, Z		41BC80J##17YY	4ABC80J##17YY	450	45BC80J##17YY	450	46BC80J##17YY		
ECO-RUBBER	53, P3			41SN80UC##17YY	4ASN80UC##17YY	450	45SN80UC##17YY	450	46SN80UC##17YY		
RUBBER ON ALUMINUM	04, 09, 48, 60, 57			41RA80JB##17YY	4ARA80JB##17YY	600	45RA80JB##17YY	600	46RA80JB##17YY		
MOLD-ON RUBBER	04, 09, 48, 60, 57			41RS80JB##17YY	4ARS80JB##17YY	600	45RS80JB##17YY	600	46RS80JB##17YY		
SUPREME RUBBER	63, 73			41RH80JS##17YY	4ARH80JS##17YY	800	45RH80JS##17YY	800	46RH80JS##17YY		
THERMO-PRO™	04, 09, 60, 63, 48, 57	A, I, T, X, Y, Z		41TP80J##17YY	4ATP80J##17YY	600	45TP80J##17YY	600	46TP80J##17YY		
POLYOLEFIN	04, 09, 60, 53, P3, 48, 57, 90	B, E		41PO80J##17YY	4APO80J##17YY	900	45PO80J##17YY	900	46PO80J##17YY		
NYLON	04, 09, 60, 48, 57			41NY80JE##17YY	4ANY80JE##17YY	1100	45NY80JE##17YY	1100	46NY80JE##17YY		
IRONMAN	65, 73			41NX80JB##17YY	4ANX80JB##17YY	1500	45NX80JB##17YY	2200	46NX80JB##17YY		
ROKHARD™	04, 09, 48, 60, 57			41HI80JB##17YY	4AHI80JB##17YY	1100	45HI80JB##17YY	1100	46HI80JB##17YY		
BRIMSTONE®	04, 09, 60, 90			41GN80JQ##17YY	4AGN80JQ##17YY	1200	45GN80JQ##17YY	1200	46GN80JQ##17YY		
EPOXY	04, 09, 90			41OV80JQ##17YY	4AOV80JQ##17YY	1200	45OV80JQ##17YY	1200	46OV80JQ##17YY		
MAXROK™	04, 09, 48, 60, 57			41MA80JB##17YY	4AMA80JB##17YY	1400	45MA80JB##17YY	1400	46MA80JB##17YY		
PHENOLIC	04, 09, 60, 57			41PH80JB##17YY	4APH80JB##17YY	1400	45PH80JB##17YY	1400	46PH80JB##17YY		
HIGH-TEMP PHENOLIC	04, 09, 60, 90			41HT80JQ##17YY	4AHT80JQ##17YY	1100	45HT80JQ##17YY	1100	46HT80JQ##17YY		
POLY MAXROK™	04, 09, 48, 60, 57	G, K		41MU80J##17YY	4AMU80J##17YY	1400	45MU80J##17YY	1400	46MU80J##17YY		
POLYON AL™	04, 09, 48, 60, 57	N, R		41PA80J##17YY	4APA80J##17YY	1500	45PA80J##17YY	1500	46PA80J##17YY		
DW-BLACK				41DW80JLT317YY	4ADW80JLT317YY	750	45DW80JLT317YY	750	46DW80JLT317YY		
DW-RED				41DW80JRT317YY	4ADW80JRT317YY	1100	45DW80JRT317YY	1100	46DW80JRT317YY		
DW-BLUE				41DW80JBT317YY	4ADW80JBT317YY	1500	45DW80JBT317YY	1600	46DW80JBT317YY		
DW-GRAY				41DW80JGT317YY	4ADW80JGT317YY	1500	45DW80JGT317YY	1700	46DW80JGT317YY		
POLY-PRO™	04, 09, 48, 60, 63, 57	C, D, I, K, M, U, W		41PP80J##17YY	4APP80J##17YY	800	45PP80J##17YY	800	46PP80J##17YY		
				41PP80JP4917YY	4APP80JP4917YY	900	45PP80JP4917YY	900	46PP80JP4917YY		
				41PP80JH6317YY	4APP80JH6317YY	1000	45PP80JH6317YY	1000	46PP80JH6317YY		
POLYMAC™	04, 09, 48, 60, 63, 57	I, M		41PM80J##17YY	4APM80J##17YY	1000	45PM80J##17YY	1000	46PM80J##17YY		
POLYON™	04, 09, 60	G, V		41PU80JV6317YY	4APU80JV6317YY	1400	45PU80JV6317YY	1400	46PU80JV6317YY		
ENERGY SAVER POLYON™	04, 09, 60			41SW80JU##17YY	4ASW80JU##17YY	1500	45SW80JU##17YY	1500	46SW80JU##17YY		

41, 45, 4A, 46 – MEDIUM HEAVY DUTY KINGPINLESS SERIES – 2,500 LB

Wheel Dia.	Thread Width	Wheel Type	Available Bearing Options	+ Color	Replace + with a desired wheel color. Replace ## with desired wheel bearing.					
					41 Series Part #	4A Series Part #	Load Cap.	45 Series Part #	Load Cap.	46 Series Part #
8	2	POLYFLEXON™ CAST			41RP80JK6317YY	4ARP80JK6317YY	1000	45RP80JK6317YY	1000	46RP80JK63™YY
		POLYFLEXON™		N, O	41UA80J+6417YY	4AUA80J+6417YY	1200	45UA80J+6417YY	1200	46UA80J+64™YY
		D-POLYON			41UD80JL6417YY	4AUD80JL6417YY	1200	45UD80JL6417YY	1200	46UD80JL64™YY
		ULTRAFLEX™			41UX80JO6417YY	4AUX80JO6417YY	1200	45UX80JO6417YY	1200	46UX80JO64™YY
		CHAMPION			41CP80JN6417YY	4ACP80JN6417YY	1500	45CP80JN6417YY	1500	46CP80JN64™YY
		DURALASTOMER™	09, 60, 63, 57		41SU80JL##17YY	4ASU80JL##17YY	1000	45SU80JL##17YY	1000	46SU80JL##™YY
		SUPER ELASTOMER			41EE80JI6017YY	4AEE80JI6017YY	1250	45EE80JI6017YY	1250	46EE80JI60™YY
		ERGOLASTOMER™	04, 09, 73, 64, 57		41HU80JI##17YY	4AHU80JI##17YY	1500	45HU80JI##17YY	2000	46HU80JI##™YY
		SEMI-STEEL	04, 09		41SS80JS##17YY	4ASS80JS##17YY	1400	45SS80JS##17YY	1400	46SS80JS##™YY
		HEAVY DUTY IRON	04, 09, 63		41HS80JS##17YY	4AHS80JS##17YY	1500	45HS80JS##17YY	1600	46HS80JS##™YY
		DUCTILE	04, 09, 63, 73, B1, B5		41DS80JR##17YY	4ADS80JR##17YY	1500	45DS80JR##17YY	2000	46DS80JR##™YY
		ENERGY SAVER DUCTILE™	04, 09, B1, B5		41CD80JR##17YY	4ACD80JR##17YY	1500	45CD80JR##17YY	2000	46CD80JR##™YY
		FORGED STEEL	04, 09, 73, 63, B5, B1		41FS80JS##17YY	4AFS80JS##17YY	1500	45FS80JS##17YY	2500	46FS80JS##™YY
IRON V-GROOVE	04, 09		41VG80JT##17YY	4AVG80JT##17YY	1200	45VG80JT##17YY	1200	46VG80JT##™YY		



**EN – NEO-ENERGIZER™**

This wheel is made with an 80% true virgin Neoprene rubber compound. It is the best rubber material for applications containing oil, abrasion, and ozone wear. It is the optimum wheel suited for a variety of applications. *For more information please find page 135.*

## 4K/4R – HIGH PERFORMANCE MAINTENANCE FREE EXTENDED SWIVEL LEAD SERIES – 2,500LB NEW



4K

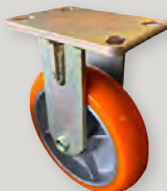

4R

Swivel device is a combination of Ball Thrust Ball Bearings and Taper Roller Bearings for its maximum performance

- Taper Roller Bearings in upper raceway to handle axial loads while operating at high speeds
- Ball Thrust Ball Bearings as lower raceway to handle combined heavy radial and thrust loads
- Extended swivel radius reduces the effort to start and swivel by half the force
- 3/8" thick top plate with legs formed from 5/16" steel
- Designed for Ultimate solution of traditional casters with kingpin being loosened from lateral force
- Yellow zinc plated to distinguish its superiority

### FASTENING SPECIFICATIONS

Plate Code	Overall Size	Bolt Hole Pattern	Mounting Bolt Size
19	4-1/2 X 6-1/4	2-7/16 X 4-15/16 TO 3-3/8 X 5-1/4	1/2

### 4K/4R – HIGH PERFORMANCE EXTENDED SWIVEL LEAD CASTER

Wheel Diameter	Thread Width	Wheel Type	Available Bearing Options	+ Color	Replace + with a desired wheel color. Replace ## with desired wheel bearing.		Load Cap.	Overall Height	Swivel Radius	
					4K Series Part #	4R Series Part #				
4	2	YOKE ONLY				4KZZ40JZ8319YY	4RZZ40JZ8319YY			
		NEO-ENERGIZER™	04, 09, 60			4KEN40JB##19YY	4REN40JB##19YY	500		
		NOMADIC™	04, 09, 60, 48, 57	I, B		4KNM40J+##19YY	4RNM40J+##19YY	400		
		RUBBER ON NYLON	04, 09, 60, 48, 57			4KNR40JB##19YY	4RNR40JB##19YY	400		
		RUBBER ON ALUMINUM	04, 09, 60, 48, 57			4KRA40JB##19YY	4RRA40JB##19YY	400		
		LOW PROFILE RUBBER				4KLP40JB0419YY	4RLP40JB0419YY	300		
		MOLD-ON RUBBER	04, 09, 60, 48, 57			4KRS40JB##19YY	4RRS40JB##19YY	400		
		THERMO-PRO™	04, 09, 60, 63, 48, 57	A, T, Y		4KTP40J+##19YY	4RTP40J+##19YY	300		
		POLYOLEFIN	04, 09, 60, 63, 48, 57	B, E		4KPO40J+##19YY	4RPO40J+##19YY	500		
		NYLON	04, 09, 60, 63, 48, 57			4KNY40JE##19YY	4RNY40JE##19YY	800		
		IRONMAN	04, 09, 65, 73			4KNX40JB##19YY	4RNX40JB##19YY	2200		
		ROKHARD™	04, 09, 60, 63, 48, 57			4KHI40JB##19YY	4RHI40JB##19YY	800		
		BRIMSTONE®	04, 09, 90			4KGN40JQ##19YY	4RGN40JQ##19YY	800		
		EPOXY	04, 09, 90			4KOV40JQ##19YY	4ROV40JQ##19YY	800		
		MAXROK™	04, 09, 60, 63, 48, 57			4KMA40JB##19YY	4RMA40JB##19YY	800		
		PHENOLIC	04, 09, 60, 63, 48, 57			4KPH40JB##19YY	4RPH40JB##19YY	800		
		PHENOLIC (STRAIGHT SIDED)	04, 09, 60, 57, 12			4KPH40TB##19YY	4RPH40TB##19YY	1000		
		HIGH-TEMP PHENOLIC	04, 09, 90			4KHT40JQ##19YY	4RHT40JQ##19YY	600		
		POLYON MAXROK™	04, 09, 60, 63, 48, 57	G, K		4KMU40J+##19YY	4RMU40J+##19YY	700		
		POLYON C192 AL™	04, 09, 60, 63, 48, 57	N, R		4KPA40J+##19YY	4RPA40J+##19YY	800		
		DW-BLACK				4KDW40JLT319YY	4RDW40JLT319YY	470		
		DW-RED				4KDW40JRT319YY	4RDW40JRT319YY	650	5-1/8	5-3/8
		DW-BLUE				4KDW40JBT319YY	4RDW40JBT319YY	960		
		DW-GRAY				4KDW40JGT319YY	4RDW40JGT319YY	1000		
		POLY-PRO™	04, 09, 60, 63, 48, 57	D, K, M, U, W		4KPP40J+##19YY	4RPP40J+##19YY	500		
						4KPP40JP19YY	4RPP40JP19YY	600		
		POLYADIC™	04, 09, 60, 63, 48, 57	I, M		4KPM40J+##19YY	4RPM40J+##19YY	600		
		POLYON™	04, 09, 60	G, V		4KPU40J+##19YY	4RPU40J+##19YY	800		
						4KPU40JV6319YY	4RPU40JV6319YY	800		
		ENERGY SAVER POLYON™	04, 09, 60, 73			4KSW40JU##19YY	4RSW40JU##19YY	800		
		POLYFLEXON™ CAST	04, 09, 60, 63, 48, 57			4KRP40JK##19YY	4RRP40JK##19YY	700		
		POLYFLEXON™		N, O		4KUA40J+6419YY	4RUA40J+6419YY	900		
		D-POLYON				4KUD40JL6419YY	4RUD40JL6419YY	900		
		ULTRAFLEX™				4KUX40JO6419YY	4RUX40JO6419YY	900		
		DURALASTOMER™	09, 60, 57			4KSU40JL##19YY	4RSU40JL##19YY	750		
		SUPER ELASTOMER				4KEE40JI6019YY	4REE40JI6019YY	1200		
		ERGOLASTOMER™	04, 09, 73, 64, 57			4KHU40JI##19YY	4RHU40JI##19YY	1000		
		SEMI-STEEL	04, 09			4KSS40JS##19YY	4RSS40JS##19YY	700		
		HEAVY DUTY IRON	04, 09, 63			4KHS40JS##19YY	4RHS40JS##19YY	900		
		DUCTILE	04, 09, 63, 73			4KDS40JR##19YY	4RDS40JR##19YY	1500		
		SOLID STEEL	09, B1, B5			4KMS40JS##19YY	4RMS40JS##19YY	2500		
		ENERGY SAVER DUCTILE™	04, 09, B1, B5			4KCD40JR##19YY	4RCD40JR##19YY	1500		



4K/4R – HIGH PERFORMANCE EXTENDED SWIVEL LEAD CASTER

Wheel Diameter	Thread Width	Wheel Type	Available Bearing Options	+ Color	Replace + with a desired wheel color. Replace ## with desired wheel bearing.		Load Cap.	Overall Height	Swivel Radius
					4K Series Part #	4R Series Part #			
4	2	MAXROK™	04, 09, 60, 57		4KMV40JT##19YY	4RMV40JT##19YY	800	5-1/8	5-3/8
		IRON V-GROOVE	04, 09		4KVG40JT##19YY	4RVG40JT##19YY	600		
		DUCTILE V-GROOVE	04, 09, B1, B5		4KDV40JT##19YY	4RDV40JT##19YY	1500		
		YOKE ONLY			4KZZ50JZ8319YY	4RZZ50JZ8319YY			
5	2	NEO-ENERGIZER™	04, 09, 60'		4KEN50JB##19YY	4REN50JB##19YY	550	6-1/2	6-3/16
		NOMADIC™	04, 09, 48, 60, 57	B, I	4KNM50J+##19YY	4RNM50J+##19YY	500		
		RUBBER ON NYLON	04, 09, 48, 60, 57		4KNR50JB##19YY	4RNR50JB##19YY	450		
		RUBBER ON ALUMINUM	04, 09, 48, 60, 57		4KRA50JB##19YY	4RRA50JB##19YY	500		
		MOLD-ON RUBBER	04, 09, 60, 48, 57		4KRS50JB##19YY	4RRS50JB##19YY	400		
		CUSHENDURE™			4KGR50JB1919YY	4RGR50JB1919YY	400		
		THERMO-PRO™	04, 09, 60, 48, 63, 57	A, I, T, X, Y, Z	4KTP50J+##19YY	4RTP50J+##19YY	350		
		POLYOLEFIN		B, E	4KPO50J+##19YY	4RPO50J+##19YY	650		
		NYLON	04, 09, 60, 48, 53, P3, 57		4KNY50JE##19YY	4RNY50JE##19YY	900		
		IRONMAN	65, 73		4KNX50JB##19YY	4RNX50JB##19YY	2200		
		ROKHARD™	04, 09, 48, 60, 57		4KHI50JB##19YY	4RHI50JB##19YY	900		
		BRIMSTONE®	04, 09, 60, 90		4KGN50JQ##19YY	4RGN50JQ##19YY	1000		
		EPOXY	04, 09, 90		4KOV50JQ##19YY	4ROV50JQ##19YY	1000		
		MAXROK™	04, 09, 60, 48, 57		4KMA50JB##19YY	4RMA50JB##19YY	1000		
		PHENOLIC	04, 09, 60, 48, 57, 90		4KPH50JB##19YY	4RPH50JB##19YY	1000		
		H-TEMP PHENOLIC	04, 09, 90		4KHT50JQ##19YY	4RHT50JQ##19YY	750		
		STEROLLIZER™			4KSL50JCB819YY	4RSL50JCB819YY			
		POLYON MAXROK™	04, 09, 48, 60, 57	G, K	4KMU50J+##19YY	4RMU50J+##19YY	1000		
		POLYON AL™	04, 09, 48, 60, 57	N, R	4KPA50J+##19YY	4RPA50J+##19YY	900		
		POLYON - C	04, 09, 48, 60, 57, 12		4KPR50JL##19YY	4RPR50JL##19YY	900		
		DW-BLACK			4KDW50JLT319YY	4RDW50JLT319YY	550		
		DW-RED			4KDW50JRT319YY	4RDW50JRT319YY	750		
		DW-BLUE			4KDW50JBT319YY	4RDW50JBT319YY	1160		
		DW-GRAY			4KDW50JGT319YY	4RDW50JGT319YY	1200		
		POLY-PRO™	04, 09, 48, 60, 63, 57	B, C, D, K, U, M, W	4KPP50J+##19YY	4RPP50J+##19YY	600		
					4KPP50JP4919YY	4RPP50JP4919YY	700		
		POLYADIC™	04, 09, 48, 60, 63, 57	I, M	38PP50JH6319YY	38PP50JH6319YY			
					4KPM50J+##19YY	4RPM50J+##19YY	750		
		POLYON™	04, 09, 60, 48	G, V	4KPU50JV6319YY	4RPU50JV6319YY	1100		
					4KPU50J+##19YY	4RPU50J+##19YY	1100		
		ENERGY SAVER POLYON™	04, 09, 60, 48		4KSW50JU##19YY	4RSW50JU##19YY	1300		
		POLYFLEXON™ CAST	04, 09, 60, 48		4KRP50JK##19YY	4RRP50JK##19YY	800		
		POLYFLEXON™		N, O	4KUA50J+6419YY	4RUA50J+6419YY	900		
		D-POLYON			4KUD50JL6419YY	4RUD50JL6419YY	900		
		ULTRAFLEX™			4KUX50JO6419YY	4RUX50JO6419YY	900		
		DURALASTOMER™	09, 60, 57		4KSU50JL##19YY	4RSU50JL##19YY	900		
		SUPER ELASTOMER			4KEE60JI6019YY	4REE60JI6019YY	1200		
		ERGOLASTOMER™	04, 09, 73, 64, 57		4KHU50JI##19YY	4RHU50JI##19YY	1400		
		SEMI-STEEL	04, 09		4KSS50JS##19YY	4RSS50JS##19YY	1000		
		HEAVY DUTY IRON	04, 09, 63		4KHS50JS##19YY	4RHS50JS##19YY	1200		
		DUCTILE	04, 09, 73, 63, B1, B5		4KDS50JR##19YY	4RDS50JR##19YY	1500		
		FORGED STEEL	04, 09, B5, B1		4KFS50JS##19YY	4RFS50JS##19YY	2500		
		ENERGY SAVER DUCTILE™	04, 09, B1, B5		4KCD50JR##19YY	4RCD50JR##19YY	1500		
		IRON V-GROOVE	04, 09		4KVG50JT##19YY	4RVG50JT##19YY	900		
		YOKE ONLY			4KZZ60JZ8319YY	4RZZ60JZ8319YY			
		NEO-ENERGIZER™	04, 09, 60		4KEN60JB##19YY	4REN60JB##19YY	600		
		PNEUMATIC			4KFP60JB6019YY	4RFP60JB6019YY	200		
FOAM FILLED			4KFF60JB6019YY	4RFF60JB6019YY	200				
EVER-ROLL™		B, I	4KER60J+6019YY	4RER60J+6019YY	200				
NOMADIC™	04, 09, 48, 60, 57		4KNM60JB##19YY	4RNM60JB##19YY	600				
RUBBER ON NYLON	04, 09, 48, 60, 57		4KNR60JB##19YY	4RNR60JB##19YY	550				
DURA-CUSHION™	04, 09, 63	X, Z	4KBC60J+##19YY	4RBC60J+##19YY	350				
ECO-RUBBER	53, P3		4KSN60JC##19YY	4RSN60JC##19YY	350				
RUBBER ON ALUMINUM	04, 09, 48, 60, 57		4KRA60JB##19YY	4RRA60JB##19YY	550				
LOW PROFILE RUBBER			4KLP60JB0419YY	4RLP60JB0419YY	600				
MOLD-ON RUBBER	04, 09, 48, 60, 57		4KRS60JB##19YY	4RRS60JB##19YY	550				
SUPREME RUBBER	63, 73		4KRH60JS##19YY	4RRH60JS##19YY	700				
THERMO-PRO™	04, 09, 60, 63, 48, 57	A, I, T, X, Y, Z	4KTP60J+##19YY	4RTP60J+##19YY	500				
POLYOLEFIN	04, 09, 60, 53, P3, 48, 57	B, E	4KPO60J+##19YY	4RPO60J+##19YY	700				
NYLON	04, 09, 48, 60, 57		4KNY60JE##19YY	4RNY60JE##19YY	1000				
IRONMAN			4KNX60JB6519YY	4RNX60JB6519YY	2200				
ROKHARD™	04, 09, 48, 60, 57		4KHI60JB##19YY	4RHI60JB##19YY	1000				
BRIMSTONE®	04, 09, 60, 90		4KGN60JQ##19YY	4RGN60JQ##19YY	1100				
EPOXY	04, 09, 90		4KOV60JQ##19YY	4ROV60JQ##19YY	1100				



# DURABLE SUPERIOR CASTERS®

4K/4R – HIGH PERFORMANCE EXTENDED SWIVEL LEAD CASTER

Wheel Diameter	Thread Width	Wheel Type	Available Bearing Options	+ Color	Replace + with a desired wheel color. Replace # with desired wheel bearing.		Load Cap.	Overall Height	Swivel Radius	
					4K Series Part #	4R Series Part #				
6	2	MAXROK™	04, 09, 60, 48, 57			4KMA60JB##19YY	4RMA60JB##19YY	1200	7-1/2	6-7/8
		PHENOLIC	04, 09, 60, 48, 57			4KPH60JB##19YY	4RPH60JB##19YY	1200		
		PHENOLIC (STRAIGHT SIDED)				4KPH60TB##19YY	4RPH60TB##19YY	1500		
		HIGH-TEMP PHENOLIC	04, 09, 90			4KHT60JQ##19YY	4RHT60JQ##19YY	1000		
		POLY MAXROK™	04, 09, 60, 48, 57	G, K		4KMU60J+##19YY	4RMU60J+##19YY	1100		
		POLYON AL™	04, 09, 48, 60, 57	N, R		4KPA60J+##19YY	4RPA60J+##19YY	1100		
		POLYON-C	04, 09, 48, 60, 57, 12			4KPR60JL##19YY	4RPR60JL##19YY	1200		
		DW-BLACK				4KDW60JLT319YY	4RDW60JLT319YY	700		
		DW-RED				4KDW60JRT319YY	4RDW60JRT319YY	960		
		DW-BLUE				4KDW60JBT319YY	4RDW60JBT319YY	1440		
		DW-GRAY				4KDW60JGT319YY	4RDW60JGT319YY	2200		
		POLY-PRO™	04, 09, 48, 60, 57	D, I, K, M, W, U		4KPP60J+##19YY	4RPP60J+##19YY	720		
						4KPP60JP4919YY	4RPP60JP4919YY	900		
						4KPP60JH6319YY	4RPP60JH6319YY			
		POLYADIC™	04, 09, 48, 60, 63, 57	I, M		4KPM60J+##19YY	4RPM60J+##19YY	900		
		POLYON™	04, 09, 60	G, V		4KPU60J+##19YY	4RPU60J+##19YY	1200		
						4KPU60J+##19YY	4RPU60J+##19YY			
		ENERGY SAVER POLYON™	04, 09, 63, 73			4KSW60JU##19YY	4RSW60JU##19YY	1400		
		POLYFLEXON™ CAST	04, 09, 60, 48, 57			4KRP60JK##19YY	4RRP60JK##19YY	900		
		POLYFLEXON™		N, O		4KUA60J+6419YY	4RUA60J+6419YY	1000		
		D-POLYON				4KUD60JL6419YY	4RUD60JL6419YY	1000		
		ULTRAFLEX™				4KUX60JO6419YY	4RUX60JO6419YY	1000		
		CHAMPION				4KCP60JN6419YY	4RCP60JN6419YY	1200		
		DURALASTOMER™	09, 60, 57			4KSU60JL##19YY	4RSU60JL##19YY	1000		
		SUPER ELASTOMER				4KEE60JI6019YY	4REE60JI6019YY	1320		
		ERGOLASTOMER™	04, 09, 73, 64, 57			4KHU60JI##19YY	4RHU60JI##19YY	1700		
		SEMI-STEEL	04, 09			4KSS60JS##19YY	4RSS60JS##19YY	1200		
		HEAVY DUTY IRON	04, 09, 63			4KHS60JS##19YY	4RHS60JS##19YY	1400		
		DUCTILE	04, 09, 73, 63, B1, B5			4KDS60JR##19YY	4RDS60JR##19YY	2000		
						4KCD60JR##19YY	4RCD60JR##19YY	2000		
ENERGY SAVER DUCTILE™	04, 09, B1, B5			4KFS60JS##19YY	4RFS60JS##19YY	2500				
FORGED STEEL	04, 09, 73, 63, B1, B5			4KVG60JT##19YY	4RVG60JT##19YY	1000				
IRON V-GROOVE	04, 09			4KDV60JT##19YY	4RDV60JT##19YY	1500				
DUCTILE V-GROOVE	04, 09, B1, B5									
YOKE ONLY					4KZZ80JZ8319YY	4RZZ80JZ8319YY		10-1/8	7-1/2	
NEO-ENERGIZER™	04, 09, 60			4KEN80JB##19YY	4REN80JB##19YY	600				
NOMADIC™	04, 09, 48, 60, 57	B, I		4KNM80J+##19YY	4RNM80J+##19YY	700				
RUBBER ON NYLON	04, 09, 48, 60, 57			4KNR80JB##19YY	4RNR80JB##19YY	600				
DURA-CUSHION™	04, 09, 63	X, Z		4KBC80J+##19YY	4RBC80J+##19YY	450				
ECO-RUBBER	53, P3			4KSN80UC##19YY	4RSN80UC##19YY	450				
RUBBER ON ALUMINUM	04, 09, 48, 60, 57			4KRA80JB##19YY	4RRA80JB##19YY	600				
MOLD-ON RUBBER	04, 09, 48, 60, 57			4KRS80JB##19YY	4RRS80JB##19YY	600				
SUPREME RUBBER	63, 73			4KRH80JS##19YY	4RRH80JS##19YY	800				
THERMO-PRO™	04, 09, 60, 63, 48, 57	A, I, T, X, Y, Z,		4KTP80J+##19YY	4RTP80J+##19YY	600				
POLYOLEFIN	04, 09, 60, 53, P3, 48, 57, 90	B, E		4KPO80J+##19YY	4RPO80J+##19YY	900				
NYLON	04, 09, 60, 48, 57			4KNY80JE##19YY	4RNY80JE##19YY	1100				
IRONMAN				4KNX80JB6519YY	4RNX80JB6519YY	2200				
ROKHARD™	04, 09, 48, 60, 57			4KHI80JB##19YY	4RHI80JB##19YY	1100				
BRIMSTONE®	04, 09, 60, 90			4KGN80JQ##19YY	4RGN80JQ##19YY	1200				
EPOXY	04, 09, 90			4KOV80JQ##19YY	4ROV80JQ##19YY	1200				
MAXROK™	04, 09, 48, 60, 57	G, K		4KMA80JB##19YY	4RMA80JB##19YY	1400				
PHENOLIC	04, 09, 60, 57			4KPH80JB##19YY	4RPH80JB##19YY	1400				
HIGH-TEMP PHENOLIC	04, 09, 60, 90			4KHT80JQ##19YY	4RHT80JQ##19YY	1100				
POLY MAXROK™	04, 09, 48, 60, 57	G, K		4KMU80J+##19YY	4RMU80J+##19YY	1400				
POLYON AL™	04, 09, 48, 60, 57	N, R		4KPA80J+##19YY	4RPA80J+##19YY	1500				
DW-BLACK				4KDW80JLT319YY	4RDW80JLT319YY	750				
DW-RED				4KDW80JRT319YY	4RDW80JRT319YY	1100				
DW-BLUE				4KDW80JBT319YY	4RDW80JBT319YY	1600				
DW-GRAY				4KDW80JGT319YY	4RDW80JGT319YY	1700				
POLY-PRO™	04, 09, 48, 60, 63, 57	C, D, I, K, M, U, W		4KPP80J+##19YY	4RPP80J+##19YY	800				
				4KPP80JP4919YY	4RPP80JP4919YY	1000				
				4KPP80JH6319YY	4RPP80JH6319YY					
POLYADIC™	04, 09, 48, 60, 63, 57	I, M		4KPM80J+##19YY	4RPM80J+##19YY	1000				
POLYON™	04, 09, 60	G, V		4KPU80JV6319YY	4RPU80JV6319YY	1400				
				4KPU80J+##19YY	4RPU80J+##19YY					
ENERGY SAVER POLYON™	04, 09, 60			4KSW80JU##19YY	4RSW80JU##19YY	1500				
POLYFLEXON™ CAST				4KRP80JK6319YY	4RRP80JK6319YY	1000				



4K/4R – HIGH PERFORMANCE EXTENDED SWIVEL LEAD CASTER

Wheel Diameter	Thread Width	Wheel Type	Available Bearing Options	+ Color	Replace + with a desired wheel color. Replace ## with desired wheel bearing.		Load Cap.	Overall Height	Swivel Radius
					4K Series Part #	4R Series Part #			
10-1/8	7-1/2	POLYFLEXON™		N, O	4KUA80J+6419YY	4RUA80J+6419YY	1200	10-1/8	7-1/2
		D-POLYON			4KUD80JL6419YY	4RUD80JL6419YY	1200		
		ULTRAFLEX™			4KUX80JO6419YY	4RUX80JO6419YY	1200		
		CHAMPION			4KCP80JN6419YY	4RCP80JN6419YY	1500		
		DURALASTOMER™	09, 60, 63, 57		4KSU80JL##19YY	4RSU80JL##19YY	1000		
		SUPER ELASTOMER			4KEE80JI6019YY	4REE80JI6019YY	1250		
		ERGOLASTOMER™	04, 09, 73, 64, 57		4KHU80JI##19YY	4RHU80JI##19YY	2000		
		SEMI-STEEL	04, 09		4KSS80JS##19YY	4RSS80JS##19YY	1400		
		HEAVY DUTY IRON	04, 09, 63		4KHS80JS##19YY	4RHS80JS##19YY	1600		
		DUCTILE	04, 09, 63, 73, B1, B5		4KDS80JR##19YY	4RDS80JR##19YY	2000		
		ENERGY SAVER DUCTILE™	04, 09, B1, B5		4KCD80JR##19YY	4RCD80JR##19YY	2000		
		FORGED STEEL	04, 09, 73, 63, B5, B1		4KFS80JS##19YY	4RFS80JS##19YY	2500		
		IRON V-GROOVE	04, 09		4KVG80JT##19YY	4RVG80JT##19YY	1200		

SIT BACK AND RELAX WITH OUR NEW MAINTENANCE FREE CASTERS!

We had ergonomics in mind when creating this state of the art caster. If you want less work-related injuries, easy push/pull initiation and rollability, and no constant maintenance. This caster series is for you!



## 4L – MODULAR STEM SERIES – 1500LB

**NEW**



- ASTM1045 forged integral structure of hardened raceway
- 3/4" hexagon mounting hole to secure the modular stem
- Bright zinc as standard

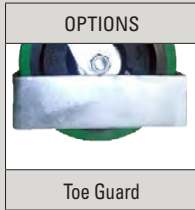

FASTENING OPTIONS						
Replace ** in part # with desired stem code.						
Stem Code	Spec.	Stem Type	Modular Part #	Size	Swivel Radius	Overall Height
ZZ		3/4" HEXAGON HOLE		4	3-3/16	5-7/16
T1	3/4-10 X 2-1/4	THREADED	4LSTT1	5	3-7/8	6-5/16
S7	3/4-10 X 4-1/4		4LSTS7	6	4-9/16	7-5/16
T2	1-8 X 2-1/4		4LSTST2	8	5-15/16	9-5/16
C7	1-8 X 4		4LSTC7			
L2	3/4 X 4	PLAIN	4LSTL2			
L3	7/8 X 4		4LSTL3			
L4	1 X 4		4LSTL4			
L5	1-3/8 X 4		4LSTL5			
19	4-1/2 X 6-1/4		PLATE	BOLT HOLE SPACING 2-7/16 X 4-15/16 TO 3-3/8 X 5-1/4		
20	5 X 5-1/2	BOLT HOLE SPACING 4-1/8 X 4-1/2				

Please contact factory for other special stems.

### 4L – MODULAR STEM SERIES – 1500LB

Wheel Diameter	Thread Width	Wheel Type	Load Cap.	Available Bearing Options	+ Color	4L Series Part #	
4	2	YOKE ONLY					4LZZ40JZ83**YY
		NEO-ENERGIZER™	500	04, 09, 60		4LEN40JB##**YY	
		NOMADIC™	400	04, 09, 60, 48, 57	I, B	4LNM40J+##**YY	
		RUBBER ON NYLON	400	04, 09, 60, 48, 57		4LNR40JB##**YY	
		RUBBER ON ALUMINUM	400	04, 09, 60, 48, 57		4LRA40JB##**YY	
		LOW PROFILE RUBBER	300				4LLP40JB04**YY
		MOLD-ON RUBBER	400	04, 09, 60, 48, 57			4LRS40JB##**YY
		THERMO-PRO™	300	04, 09, 60, 63, 48, 57	A, T, Y		4LTP40J+##**YY
		POLYOLEFIN	500	04, 09, 60, 63, 48, 57	B, E		4LPO40J+##**YY
		NYLON	800	04, 09, 60, 63, 48, 57			4LNY40JE##**YY
		IRONMAN	1500	04, 09, 65, 73			4LNX40JB##**YY
		ROKHARD™	800	04, 09, 60, 63, 48, 57			4LHI40JB##**YY
		BRIMSTONE®	800	04, 09, 90			4LGN40JQ##**YY
		EPOXY	800	04, 09, 90			4LOV40JQ##**YY
		MAXROK™	800	04, 09, 60, 63, 48, 57			4LMA40JB##**YY
		PHENOLIC	800	04, 09, 60, 63, 48, 57			4LPH40JB##**YY
		PHENOLIC (STRAIGHT SIDED)	1000	04, 09, 60, 57, 12			4LPH40TB##**YY
		HIGH-TEMP PHENOLIC	600	04, 09, 90			4LHT40JQ##**YY
		POLYON MAXROK™	700	04, 09, 60, 63, 48, 57	G, K		4LMU40J+##**YY
		POLY AL™	800	04, 09, 60, 63, 48, 57	N, R		4LPA40J+##**YY
		DW-BLACK	500				4LDW40JLT3**YY
		DW-RED	475				4LDW40JRT3**YY
		DW-BLUE	650				4LDW40JBT3**YY
		DW-GRAY	960				4LDW40JGT3**YY
		POLY-PRO™	500	04, 09, 60, 63, 48, 57	D, K, M, U, W		4LPP40J+##**YY
			600				4LPP40JP49**YY
		POLYADIC™	600	04, 09, 60, 63, 48, 57	I, M		4LPM40J+##**YY
		POLYON™	800	04, 09, 60	G, V		4LPU40J+##**YY
			800				4LPU40JV63**YY
		ENERGY SAVER POLYON™	800	04, 09, 60, 73			4LSW40JU##**YY
		POLYFLEXON™ CAST	700	04, 09, 60, 63, 48, 57			4LRP40JK##**YY
		POLYFLEXON™	900		N, O		4LUA40J+64**YY
		D-POLYON	900				4LUD40JL64**YY
		ULTRAFLEX™	500				4LUX40JL64**YY
		DURALASTOMER™	750	09, 60, 57			4LSU40JL##**YY
		SUPER ELASTOMER	1200				4LEE40JI60**YY
		ERGOLASTOMER™	1000	04, 09, 73, 64, 57			4LHU40JI##**YY
		SEMI-STEEL	700	04, 09			4LSS40JS##**YY
		HEAVY DUTY IRON	900	04, 09, 63			4LHS40JS##**YY
		DUCTILE	1500	04, 09, 63, 73			4LDS40JR##**YY
		SOLID STEEL	1500	09, B1, B5			4LMS40JS##**YY
		ENERGY SAVER DUCTILE™	1500	04, 09, B1, B5			4LCD40JR##**YY
		MAXROK™ V-GROOVE	800	04, 09, 60, 57			4LMV40JT##**YY

4L – MODULAR STEM SERIES – 1500LB

Wheel Diameter	Thread Width	Wheel Type	Load Cap.	Available Bearing Options	+ Color	4L Series Part #	
5	2	YOKE ONLY					4LZZ50JZ83**YY
		NEO-ENERGIZER™	550	04, 09, 60'			4LEN50JB##**YY
		NOMADIC™	500	04, 09, 48, 60, 57		B, I	4LNM50J+##**YY
		RUBBER ON NYLON	450	04, 09, 48, 60, 57			4LNR50JB##**YY
		RUBBER ON ALUMINUM	500	04, 09, 48, 60, 57			4LRA50JB##**YY
		MOLD-ON RUBBER	400	04, 09, 60, 48, 57			4LRS50JB##**YY
		CUSHENDURE™	400				4LGR50JB19**YY
		THERMO-PRO™	350	04, 09, 60, 48, 63, 57		A, I, T, X, Y, Z	4LTP50J+##**YY
		POLYOLEFIN	650			B, E	4LPO50J+##**YY
		NYLON	900	04, 09, 60, 48, 53, P3, 57			4LNY50JE##**YY
		IRONMAN	1500	65, 73			4LNX50JB##**YY
		ROKHARD™	900	04, 09, 48, 60, 57			4LHI50JB##**YY
		BRIMSTONE®	1000	04, 09, 60, 90			4LGN50JQ##**YY
		EPOXY	1000	04, 09, 90			4LOV50JQ##**YY
		MAXROK™	1000	04, 09, 60, 48, 57			4LMA50JB##**YY
		PHENOLIC	1000	04, 09, 60, 48, 57, 90			4LPH50JB##**YY
		H-TEMP PHENOLIC	750	04, 09, 90			4LHT50JQ##**YY
		STEROLLIZER™	450				4LSL50JCB8**YY
		POLYON MAXROK™	1000	04, 09, 48, 60, 57		G, K	4LMU50J+##**YY
		POLYON AL™	900	04, 09, 48, 60, 57		N, R	4LPA50J+##**YY
		POLYON - C	900	04, 09, 48, 60, 57, 12			4LPR50JL##**YY
		DW-BLACK	550				4LDW50JLT3**YY
		DW-RED	750				4LDW50JRT3**YY
		DW-BLUE	1160				4LDW50JBT3**YY
		DW-GRAY	1200				4LDW50JGT3**YY
		POLY-PRO™	600	04, 09, 48, 60, 63, 57		B, C, D, K, U, M, W	4LPP50J+##**YY
			700				4LPP50JP49**YY
							4LPP50JH63**YY
		POLYMADIC™	750	04, 09, 48, 60, 63, 57		I, M	4LPM50J+##**YY
		POLYON™	1100				4LPU50JV63**YY
			1100	04, 09, 60, 48		G, V	4LPU50J+##**YY
		ENERGY SAVER POLYON™	1500	04, 09, 60, 48			4LSW50JU##**YY
		POLYFLEXON™ CAST	800	04, 09, 60, 48			4LRP50JK##**YY
		POLYFLEXON™	900			N, O	4LUA50J+64**YY
		D-POLYON	900				4LUD50JL64**YY
		DURALASTOMER™	900	09, 60, 57			4LSU50JL##**YY
		ULTRAFLEX™	900	09, 60, 57			4LUX50JO64**YY
		SUPER ELASTOMER	1200				4LEE60JI60**YY
		ERGOLASTOMER™	1400	04, 09, 73, 64, 57			4LHU50JI##**YY
		SEMI-STEEL	1000	04, 09			4LSS50JS##**YY
		HEAVY DUTY IRON	1200	04, 09, 63			4LHS50JS##**YY
		DUCTILE	1500	04, 09, 73, 63, B1, B5			4LDS50JR##**YY
FORGED STEEL	1500	02, 09, B5, B1			4LFS50JS##**YY		
ENERGY SAVER DUCTILE™	1500	04, 09, B1, B5			4LCD50JR##**YY		
6	2	YOKE ONLY					4LZZ60JZ83**YY
		NEO-ENERGIZER™	600	04, 09, 60			4LEN60JB##**YY
		PNEUMATIC	200				4LFP60JB60**YY
		FOAM FILLED	200				4LFF60JB60**YY
		EVER-ROLL™	200			B, I	4LER60J+60**YY
		NOMADIC™	600	04, 09, 48, 60, 57			4LNM60JB##**YY
		RUBBER ON NYLON	550	04, 09, 48, 60, 57			4LNR60JB##**YY
		DURA-CUSHION™	350	04, 09, 63		X, Z	4LBC60J+##**YY
		ECO-RUBBER	350	53, P3			4LSN60JC##**YY
		RUBBER ON ALUMINUM	550	04, 09, 48, 60, 57			4LRA60JB##**YY
		LOW PROFILE RUBBER	600				4LLP60JB04**YY
		MOLD-ON RUBBER	550	04, 09, 48, 60, 57			4LRS60JB##**Y
		SUPREME RUBBER	700	63, 73			4LRH60JS##**YY
		THERMO-PRO™	500	04, 09, 60, 63, 48, 57		A, I, T, X, Y, Z	4LTP60J+##**YY
		POLYOLEFIN	700	04, 09, 60, 53, P3, 48, 57		B, E	4LPO60J+##**YY
		NYLON	1000	04, 09, 48, 60, 57			4LNY60JE##**YY
		IRONMAN	1500	65, 73			4LNX60JB##**YY
		ROKHARD™	1000	04, 09, 48, 60, 57			4LHI60JB##**YY
		BRIMSTONE®	1100	04, 09, 60, 90			4LGN60JQ##**YY
		EPOXY	1100	04, 09, 90			4LOV60JQ##**YY
		MAXROK™	1200	04, 09, 60, 48, 57			4LMA60JB##**YY
		PHENOLIC	1200	04, 09, 60, 48, 57			4LPH60JB##**YY
			1250				4LPH60TB##**YY
		HIGH-TEMP PHENOLIC	900	04, 09, 90			4LHT60JQ##**YY
		POLY MAXROK™	1200	04, 09, 60, 48, 57		G, K	4LMU60J+##**YY
		POLYON AL™	1200	04, 09, 48, 60, 57		N, R	4LPA60J+##**YY
		POLYON-C	1200	04, 09, 48, 60, 57, 12			4LPR60JL##**YY
		DW-BLACK	700				4LDW60JLT3**YY
		DW-RED	900				4LDW60JRT3**YY
		DW-BLUE	1400				4LDW60JBT3**YY



# DURABLE SUPERIOR CASTERS®

4L – MODULAR STEM SERIES – 1500LB

Wheel Diameter	Thread Width	Wheel Type	Load Cap.	Available Bearing Options	+ Color	4L Series Part #	
6	2	DW-GRAY	1440				4LDW60JGT3**YY
		POLY-PRO™	720	04, 09, 48, 60, 57, 63	D, I, K, M, W, U	4LPP60J+##**YY	
			900			4LPP60JP49**YY	
		POLYMADIC™	900	04, 09, 48, 60, 63, 57		I, M	4LPM60J+##**YY
		POLYON™	1200			G, V	4LPU60JV63**YY
		ENERGY SAVER POLYON™	1400	04, 09, 63, 73			4LSW60JU##**YY
		POLYFLEXON™ CAST	900	04, 09, 60, 48, 57			4LRP60JK##**YY
		POLYFLEXON™	900			N, O	4LUA60J+64**YY
		D-POLYON	900				4LUD60JL64**YY
		ULTRAFLEX™	700				4LUX60J064**YY
		CHAMPION	1200				4LCP60JN64**YY
		DURALASTOMER™	1000	09, 60, 57			4LSU60JL##**YY
		SUPER ELASTOMER	1320				4LEE60J160**YY
		ERGOLASTOMER™	1700	04, 09, 73, 64, 57			4LHU60JI##**YY
		SEMI-STEEL	1200	04, 09			4LSS60JS##**YY
		HEAVY DUTY IRON	1400	04, 09, 63			4LHS60JS##**YY
		DUCTILE	1500	04, 09, 73, 63, B1, B5			4LDS60JR##**YY
		ENERGY SAVER DUCTILE™	1500	04, 09, B1, B5			4LCD60JR##**YY
		FORGED STEEL	1500	04, 09, 73, 63, B1, B5			4LFS60JS##**YY
		IRON V-GROOVE	1000	04, 09			4LVG60JT##**YY
		DUCTILE V-GROOVE	1500	04, 09, B1, B5			4LDV60JT##**YY
8	2	YOKE ONLY					4LZZ80JZ83**YY
		NEO-ENERGIZER™	600	04, 09, 60			4LEN80JB##**YY
		NOMADIC™	700	04, 09, 48, 60, 57		B, I	4LNM80J+##**YY
		RUBBER ON NYLON	600	04, 09, 48, 60, 57			4LNR80JB##**YY
		DURA-CUSHION™	450	04, 09, 63		X, Z	4LBC80J+##**YY
		ECO-RUBBER	450	53, P3			4LSN80JC##**YY
		RUBBER ON ALUMINUM	600	04, 09, 48, 60, 57			4LRA80JB##**YY
		MOLD-ON RUBBER	600	04, 09, 48, 60, 57			4LRS80JB##**YY
		SUPREME RUBBER	800	63, 73			4LRH80JS##**YY
		THERMO-PRO™	600	04, 09, 60, 63, 48, 57		A, I, T, X, Y, Z,	4LTP80J+##**YY
		POLYOLEFIN	900	04, 09, 60, 53, P3, 48, 57, 90		B, E	4LPO80J+##**YY
		NYLON	1100	04, 09, 60, 48, 57			4LNY80JE##**YY
		IRONMAN	1500	65, 73			4LNX80JB##**YY
		ROKHARD™	1100	04, 09, 48, 60, 57			4LHI80JB##**YY
		BRIMSTONE®	1200	04, 09, 60, 90			4LGN80JQ##**YY
		EPOXY	1200	04, 09, 90			4LOV80JQ##**YY
		MAXROK™	1400	04, 09, 48, 60, 57			4LMA80JB##**YY
		PHENOLIC	1250	04, 09, 60, 57			4LPH80JB##**YY
		HIGH-TEMP PHENOLIC	1100	04, 09, 60, 90			4LHT80JQ##**YY
		POLY MAXROK™	1250	04, 09, 48, 60, 57		G, K	4LMU80J+##**YY
		POLYON AL™	1500	04, 09, 48, 60, 57		N, R	4LPA80J+##**YY
		DW-BLACK	750				4LDW80JLT3**YY
		DW-RED	1100				4LDW80JRT3**YY
		DW-BLUE	1500				4LDW80JBT3**YY
		DW-GRAY	1500				4LDW80JGT3**YY
		POLY-PRO™	800	04, 09, 48, 60, 63, 57		C, D, I, K, M, U, W	4LPP80J+##**YY
			1000				4LPP80JP49**YY
		POLYMADIC™	1000	04, 09, 48, 60, 63, 57		I, M	4LPM80J+##**YY
		POLYON™	1400			G, V	4LPU80JV63**YY
		ENERGY SAVER POLYON™	1500	04, 09, 60			4LPU80J+##**YY
		POLYFLEXON™ CAST	1000				4LSW80JU##**YY
		POLYFLEXON™	1000			N, O	4LRP80JK63**YY
		D-POLYON	1000				4LUA80J+64**YY
		CHAMPION	1500				4LUD80JL64**YY
		ULTRAFLEX™	800				4LCP80JN64**YY
		DURALASTOMER™	1000	09, 60, 63, 57			4LSU80JL##**YY
		SUPER ELASTOMER	1440				4LEE80J160**YY
		ERGOLASTOMER™	1500	04, 09, 73, 64, 57			4LHU80JI##**YY
		SEMI-STEEL	1400	04, 09			4LSS80JS##**YY
		HEAVY DUTY IRON	1500	04, 09, 63			4LHS80JS##**YY
		DUCTILE	1500	04, 09, 63, 73, B1, B5			4LDS80JR##**YY
		ENERGY SAVER DUCTILE™	1500	04, 09, B1, B5			4LCD80JR##**YY
		FORGED STEEL	1500	04, 09, 73, 63, B5, B1			4LFS80JS##**YY
		IRON V-GROOVE	1200	04, 09			4LVG80JT##**YY

# 43/44 – MEDIUM HEAVY DUTY SERIES – 1,500LB



- Large heat treated double ball raceways
- 3/4" kingbolt
- Zinc-plated
- 1/2" axle

BRAKE OPTIONS		
Top Lock Brake (T)	A-Cam Brake (A)	Cam-Lock Brake (C)

OTHER OPTIONS			
4-Position Lock (P)	Thread Guards (G)	Toe Guard	4-Position Lock Bolt-on. Order Separately Part # 4PSL27

FASTENING PATTERN			
Plate Code	Overall Size	Bolt Hole Pattern	Mounting Bolt Size
19	4-1/2 X 6-1/4	2-7/16 X 4-15/16 TO 3-3/8 X 5-1/4	1/2

WHEEL DIAMETER, OVERALL HEIGHT AND SWIVEL RADIUS			
Wheel Diameter	Overall Height	Swivel Radius	
4	5-5/8	3-3/8	
5	6-1/2	4	
6	7-1/2	4-3/4	
8	10-1/8	5-1/2	
8	9-1/2 (OPTIONAL HEIGHT - CHANGE PART # DIAMETER DESIGNATOR FROM 80 TO 81)		5-1/2
10	11-1/2	7	

## 43/44 – MEDIUM HEAVY DUTY SERIES – 1,500LB

Wheel Diameter	Thread Width	Wheel Type	Available Bearing Options	+ Color	Replace + with a desired wheel color. Replace ## with desired wheel bearing.		Load Cap.	
					43 Series Swivel Part #	44 Series Rigid Part #		
4	2	YOKE ONLY				43ZZ40JZ8319YY	44ZZ40JZ8319YY	
		NEO-ENERGIZER™	04, 09, 60			43EN40JB##19YY	44EN40JB##19YY	500
		NOMADIC™	04, 09, 60, 48, 57	I, B		43NM40J+##19YY	44NM40J+##19YY	400
		RUBBER ON NYLON	04, 09, 60, 48, 57			43NR40JB##19YY	44NR40JB##19YY	400
		RUBBER ON ALUMINUM	04, 09, 60, 48, 57			43RA40JB##19YY	44RA40JB##19YY	400
		LOW PROFILE RUBBER				43LP40JB0419YY	44LP40JB0419YY	300
		MOLD-ON RUBBER	04, 09, 60, 48, 57			43RS40JB##19YY	44RS40JB##19YY	400
		THERMO-PRO™	04, 09, 60, 63, 48, 57	A, T, Y		43TP40J+##19YY	44TP40J+##19YY	300
		POLYOLEFIN	04, 09, 60, 63, 48, 57	B, E		43P040J+##19YY	44P040J+##19YY	500
		NYLON	04, 09, 60, 63, 48, 57			43NY40JE##19YY	44NY40JE##19YY	800
		IRONMAN	04, 09, 65, 73			43NX40JB##19YY	44NX40JB##19YY	1500
		ROKHARD™	04, 09, 60, 63, 48, 57			43HI40JB##19YY	44HI40JB##19YY	800
		BRIMSTONE®	04, 09, 90			43GN40JQ##19YY	44GN40JQ##19YY	800
		EPOXY	04, 09, 90			43OV40JQ##19YY	44OV40JQ##19YY	800
		MAXROK™	04, 09, 60, 63, 48, 57			43MA40JB##19YY	44MA40JB##19YY	800
		PHENOLIC	04, 09, 60, 63, 48, 57			43PH40JB##19YY	44PH40JB##19YY	800
		PHENOLIC (STRAIGHT SIDED)	04, 09, 60, 57, 12			43PH40TB##19YY	44PH40TB##19YY	1000
		HIGH-TEMP PHENOLIC	04, 09, 90			43HT40JQ##19YY	44HT40JQ##19YY	600
		POLYON MAXROK™	04, 09, 60, 63, 48, 57		G, K	43MU40J+##19YY	44MU40J+##19YY	700
		POLY AL™	04, 09, 60, 63, 48, 57		N, R	43PA40J+##19YY	44PA40J+##19YY	800
		DW-BLACK				43DW40JLT319YY	44DW40JLT319YY	470
		DW-RED				43DW40JRT319YY	44DW40JRT319YY	650
		DW-BLUE				43DW40JBT319YY	44DW40JBT319YY	960
		DW-GRAY				43DW40JGT319YY	44DW40JGT319YY	1000
		POLY-PRO™	04, 09, 60, 63, 48, 57	D, K, M, U, W		43PP40J+##19YY	44PP40J+##19YY	500
						43PP40JP4919YY	44PP40JP4919YY	600
		POLYADIC™	04, 09, 60, 63, 48, 57	I, M		43PM40J+##19YY	44PM40J+##19YY	600
		POLYON™	04, 09, 60	G, V		43PU40J+##19YY	44PU40J+##19YY	800
						43PU40JV6319YY	44PU40JV6319YY	800
		ENERGY SAVER POLYON™	04, 09, 60, 73			43SW40JU##19YY	44SW40JU##19YY	800
		POLYFLEXON™ CAST	04, 09, 60, 63, 48, 57			43RP40JK##19YY	44RP40JK##19YY	700
		POLYFLEXON™		N, O		43UA40J+6419YY	44UA40J+6419YY	900
		D-POLYON				43UD40JL6419YY	44UD40JL6419YY	900
		ULTRAFLEX™				43UX40JO6419YY	44UX40JO6419YY	900
DURALASTOMER™	09, 60, 57			43SU40JL##19YY	44SU40JL##19YY	750		
SUPER ELASTOMER				43EE40JI6019YY	44EE40JI6019YY	1200		
ERGOLASTOMER™	04, 09, 73, 64, 57			43HU40JI##19YY	44HU40JI##19YY	1000		
SEMI-STEEL	04, 09			43SS40JS##19YY	44SS40JS##19YY	700		
HEAVY DUTY IRON	04, 09, 63			43HS40JS##19YY	44HS40JS##19YY	900		



# DURABLE SUPERIOR CASTERS®

43/44 – MEDIUM HEAVY DUTY SERIES – 1, 500LB

Wheel Diameter	Thread Width	Wheel Type	Available Bearing Options	+ Color	Replace + with a desired wheel color. Replace ## with desired wheel bearing.		Load Cap.			
					43 Series Swivel Part #	44 Series Rigid Part #				
5	2	DUCTILE	04, 09, 63, 73			43DS40JR##19YY	44DS40JR##19YY	1500		
		SOLID STEEL	09, B1, B5			43MS40JS##19YY	44MS40JS##19YY	1500		
		ENERGY SAVER DUCTILE™	04, 09, B1, B5			43CD40JR##19YY	44CD40JR##19YY	1500		
		MAXROK™	04, 09, 60, 57			43MV40JT##19YY	44MV40JT##19YY	800		
		IRON V-GROOVE	04, 09			43VG40JT##19YY	44VG40JT##19YY	600		
		DUCTILE V-GROOVE	04, 09, B1, B5			43DV40JT##19YY	44DV40JT##19YY	1500		
				YOKE ONLY				43ZZ50JZ8319YY	44ZZ50JZ8319YY	
		NEO-ENERGIZER™	04, 09, 60'					43EN50JB##19YY	44EN50JB##19YY	550
		NOMADIC™	04, 09, 48, 60, 57		B, I			43NM50J+##19YY	44NM50J+##19YY	500
		RUBBER ON NYLON	04, 09, 48, 60, 57					43NR50JB##19YY	44NR50JB##19YY	450
		RUBBER ON ALUMINUM	04, 09, 48, 60, 57					43RA50JB##19YY	44RA50JB##19YY	500
		MOLD-ON RUBBER	04, 09, 60, 48, 57					43RS50JB##19YY	44RS50JB##19YY	400
		CUSHENDURE™						43GR50JB1919YY	44GR50JB1919YY	400
		THERMO-PRO™	04, 09, 60, 48, 63, 57		A, I, T, X, Y, Z			43TP50J+##19YY	44TP50J+##19YY	350
		POLYOLEFIN			B, E			43PO50J+##19YY	44PO50J+##19YY	650
		NYLON	04, 09, 60, 48, 53, P3, 57					43NY50JE##19YY	44NY50JE##19YY	900
		IRONMAN	65, 73					43NX50JB##19YY	44NX50JB##19YY	1500
		ROKHARD™	04, 09, 48, 60, 57					43HI50JB##19YY	44HI50JB##19YY	900
		BRIMSTONE®	04, 09, 60, 90					43GN50JQ##19YY	44GN50JQ##19YY	1000
		EPOXY	04, 09, 90					43OV50JQ##19YY	44OV50JQ##19YY	1000
		MAXROK™	04, 09, 60, 48, 57					43MA50JB##19YY	44MA50JB##19YY	1000
		PHENOLIC	04, 09, 60, 48, 57, 90					43PH50JB##19YY	44PH50JB##19YY	1000
		H-TEMP PHENOLIC	04, 09, 90					43HT50JQ##19YY	44HT50JQ##19YY	750
		STEROLLIZER™						43SL50JCB819YY	44SL50JCB819YY	450
		POLYON MAXROK™	04, 09, 48, 60, 57		G, K			43MU50J+##19YY	44MU50J+##19YY	1000
		POLYON AL™	04, 09, 48, 60, 57		N, R			43PA50J+##19YY	44PA50J+##19YY	900
		POLYON - C	04, 09, 48, 60, 57, 12					43PR50JL##19YY	44PR50JL##19YY	900
		DW-BLACK						43DW50JLT319YY	44DW50JLT319YY	550
		DW-RED						43DW50JRT319YY	44DW50JRT319YY	750
		DW-BLUE						43DW50JBT319YY	44DW50JBT319YY	1160
		DW-GRAY						43DW50JGT319YY	44DW50JGT319YY	1200
				POLY-PRO™	04, 09, 48, 60, 63, 57	B, C, D, K, U, M, W		43PP50J+##19YY	44PP50J+##19YY	600
								43PP50JP4919YY	44PP50JP4919YY	700
								43PP50JH6319YY	44PP50JH6319YY	
				POLYMAC™	04, 09, 48, 60, 63, 57	I, M		43PM50J+##19YY	44PM50J+##19YY	750
				POLYON™				43PU50JV6319YY	44PU50JV6319YY	1100
					04, 09, 60, 48	G, V		43PU50J+##19YY	44PU50J+##19YY	1100
				ENERGY SAVER POLYON™	04, 09, 60, 48			43SW50JU##19YY	44SW50JU##19YY	1300
				POLYFLEXON™ CAST	04, 09, 60, 48			43RP50JK##19YY	44RP50JK##19YY	800
				POLYFLEXON™		N, O		43UA50J+6419YY	44UA50J+6419YY	900
				D-POLYON				43UD50JL6419YY	44UD50JL6419YY	900
				ULTRAFLEX™				43UX50JO6419YY	44UX50JO6419YY	900
				DURALASTOMER™	09, 60, 57			43SU50JL##19YY	44SU50JL##19YY	900
				SUPER ELASTOMER				43EE60JI6019YY	44EE60JI6019YY	1200
				ERGOLASTOMER™	04, 09, 73, 64, 57			43HU50JI##19YY	44HU50JI##19YY	1400
				SEMI-STEEL	04, 09			43SS50JS##19YY	44SS50JS##19YY	1000
				HEAVY DUTY IRON	04, 09, 63			43HS50JS##19YY	44HS50JS##19YY	1200
				DUCTILE	04, 09, 73, 63, B1, B5			43DS50JR##19YY	44DS50JR##19YY	1500
				FORGED STEEL	02, 09, B5, B1			43FS50JS##19YY	44FS50JS##19YY	1500
				ENERGY SAVER DUCTILE™	04, 09, B1, B5			43CD50JR##19YY	44CD50JR##19YY	1500
		IRON V-GROOVE	04, 09			43VG50JT##19YY	44VG50JT##19YY	900		
6	2	YOKE ONLY				43ZZ60JZ8319YY	44ZZ60JZ8319YY			
		NEO-ENERGIZER™	04, 09, 60			43EN60JB##19YY	44EN60JB##19YY	600		
		PNEUMATIC					43FP60JB6019YY	44FP60JB6019YY	200	
		FOAM FILLED					43FF60JB6019YY	44FF60JB6019YY	200	
		EVER-ROLL™			B, I		43ER60J+6019YY	44ER60J+6019YY	200	
		NOMADIC™	04, 09, 48, 60, 57				43NM60JB##19YY	44NM60JB##19YY	600	
		RUBBER ON NYLON	04, 09, 48, 60, 57				43NR60JB##19YY	44NR60JB##19YY	550	
		DURA-CUSHION™	04, 09, 63		X, Z		43BC60J+##19YY	44BC60J+##19YY	350	
		ECO-RUBBER	53, P3				43SN60JC##19YY	44SN60JC##19YY	350	
		RUBBER ON ALUMINUM	04, 09, 48, 60, 57				43RA60JB##19YY	44RA60JB##19YY	550	
		LOW PROFILE RUBBER					43LP60JB0419YY	44LP60JB0419YY	600	
		MOLD-ON RUBBER	04, 09, 48, 60, 57				43RS60JB##19Y	44RS60JB##19Y	550	
		SUPREME RUBBER	63, 73				43RH60JS##19YY	44RH60JS##19YY	700	
		THERMO-PRO™	04, 09, 60, 63, 48, 57		A, I, T, X, Y, Z		43TP60J+##19YY	44TP60J+##19YY	500	
		POLYOLEFIN	04, 09, 60, 53, P3, 48, 57		B, E		43PO60J+##19YY	44PO60J+##19YY	700	
		NYLON	04, 09, 48, 60, 57				43NY60JE##19YY	44NY60JE##19YY	1000	
		IRONMAN	65, 73				43NX60JB##19YY	44NX60JB##19YY	1500	
		ROKHARD™	04, 09, 48, 60, 57				43HI60JB##19YY	44HI60JB##19YY	1000	
		BRIMSTONE®	04, 09, 60, 90				43GN60JQ##19YY	44GN60JQ##19YY	1100	



43/44 – MEDIUM HEAVY DUTY SERIES – 1, 500LB

Wheel Diameter	Thread Width	Wheel Type	Available Bearing Options	+ Color	Replace + with a desired wheel color. Replace ## with desired wheel bearing.		Load Cap.	
					43 Series Swivel Part #	44 Series Rigid Part #		
6	2	EPOXY	04, 09, 90			430V60JQ##19YY	440V60JQ##19YY	1100
		MAXROK™	04, 09, 60, 48, 57			43MA60JB##19YY	44MA60JB##19YY	1200
		PHENOLIC	04, 09, 60, 48, 57			43PH60JB##19YY	44PH60JB##19YY	1200
		STRAIGHT SIDED PHENOLIC				43PH60TB##19YY	44PH60TB##19YY	1500
		HIGH-TEMP PHENOLIC	04, 09, 90			43HT60JQ##19YY	44HT60JQ##19YY	1000
		POLY MAXROK™	04, 09, 60, 48, 57	G, K		43MU60J+##19YY	44MU60J+##19YY	1100
		POLYON AL™	04, 09, 48, 60, 57	N, R		43PA60J+##19YY	44PA60J+##19YY	1100
		POLYON-C	04, 09, 48, 60, 57, 12			43PR60JL##19YY	44PR60JL##19YY	1200
		DW-BLACK				43DW60JLT319YY	44DW60JLT319YY	700
		DW-RED				43DW60JRT319YY	44DW60JRT319YY	960
		DW-BLUE				43DW60JBT319YY	44DW60JBT319YY	1400
		DW-GRAY				43DW60JGT319YY	44DW60JGT319YY	1440
		POLY-PRO™	04, 09, 48, 60, 57		D, I, K, M, W, U	43PP60J+##19YY	44PP60J+##19YY	720
						43PP60JP4919YY	44PP60JP4919YY	900
						43PP60JH6319YY	44PP60JH6319YY	
		POLYMAC™	04, 09, 48, 60, 63, 57	I, M		43PM60J+##19YY	44PM60J+##19YY	900
		POLYON™	04, 09, 60		G, V	43PU60JV6319YY	44PU60JV6319YY	1200
						43PU60J+##19YY	44PU60J+##19YY	
		ENERGY SAVER POLYON™	04, 09, 63, 73			43SW60JU##19YY	44SW60JU##19YY	1400
		POLYFLEXION™ CAST	04, 09, 60, 48, 57			43RP60JK##19YY	44RP60JK##19YY	900
		POLYFLEXION™		N, O		43UA60J+6419YY	44UA60J+6419YY	1000
		D-POLYON				43UD60JL6419YY	44UD60JL6419YY	1000
		ULTRAFLEX™				44UX60JO6419YY	44UX60JO6419YY	1000
		CHAMPION				43CP60JN6419YY	44CP60JN6419YY	1200
		DURALASTOMER™	09, 60, 57			43SU60JL##19YY	44SU60JL##19YY	1000
		SUPER ELASTOMER				43EE60JI6019YY	44EE60JI6019YY	1320
		ERGOLASTOMER™	04, 09, 73, 64, 57			43HU60JI##19YY	44HU60JI##19YY	1500
		SEMI-STEEL	04, 09			43SS60JS##19YY	44SS60JS##19YY	1200
		HEAVY DUTY IRON	04, 09, 63			43HS60JS##19YY	44HS60JS##19YY	1400
		DUCTILE	04, 09, 73, 63, B1, B5			43DS60JR##19YY	44DS60JR##19YY	1500
ENERGY SAVER DUCTILE™	04, 09, B1, B5			43CD60JR##19YY	44CD60JR##19YY	1500		
FORGED STEEL	04, 09, 73, 63, B1, B5			43FS60JS##19YY	44FS60JS##19YY	1500		
IRON V-GROOVE	04, 09			43VG60JT##19YY	44VG60JT##19YY	1000		
DUCTILE V-GROOVE	04, 09, B1, B5			43DV60JT##19YY	44DV60JT##19YY	1500		
6	2-1/2	YOKE ONLY				43ZZ60KZ8319YY	44ZZ60KZ8319YY	
		MOLD-ON RUBBER	06			43RS60KB0619YY	44RS60KB0619YY	700
		PHENOLIC	06			43PH60KB0619YY	44PH60KB0619YY	1400
		POLYON™	06			43PU60KV0619YY	44PU60KV0619YY	1500
		SEMI-STEEL	06			43SS60KS0619YY	44SS60KS0619YY	1500
8	2	YOKE ONLY				43ZZ80JZ8319YY	44ZZ80JZ8319YY	
		NEO-ENERGIZER™	04, 09, 60			43EN80JB##19YY	44EN80JB##19YY	600
		NOMADIC™	04, 09, 48, 60, 57	B, I		43NM80J+##19YY	44NM80J+##19YY	700
		RUBBER ON NYLON	04, 09, 48, 60, 57			43NR80JB##19YY	44NR80JB##19YY	600
		DURA-CUSHION™	04, 09, 63	X, Z		43BC80J+##19YY	44BC80J+##19YY	450
		ECO-RUBBER	53, P3			43SN80UC##19YY	44SN80UC##19YY	450
		RUBBER ON ALUMINUM	04, 09, 48, 60, 57			43RA80JB##19YY	44RA80JB##19YY	600
		MOLD-ON RUBBER	04, 09, 48, 60, 57			43RS80JB##19YY	44RS80JB##19YY	600
		SUPREME RUBBER	63, 73			43RH80JS##19YY	44RH80JS##19YY	800
		THERMO-PRO™	04, 09, 60, 63, 48, 57	A, I, T, X, Y, Z,		43TP80J+##19YY	44TP80J+##19YY	600
		POLYOLEFIN	04, 09, 60, 53, P3, 48, 57, 90	B, E		43PO80J+##19YY	44PO80J+##19YY	900
		NYLON	04, 09, 60, 48, 57			43NY80JE##19YY	44NY80JE##19YY	1100
		IRONMAN	65, 73			43NX80JB##19YY	44NX80JB##19YY	1500
		ROKHARD™	04, 09, 48, 60, 57			43HI80JB##19YY	44HI80JB##19YY	1100
		BRIMSTONE®	04, 09, 60, 90			43GN80JQ##19YY	44GN80JQ##19YY	1200
		EPOXY	04, 09, 90			43OV80JQ##19YY	44OV80JQ##19YY	1200
		MAXROK™	04, 09, 48, 60, 57			43MA80JB##19YY	44MA80JB##19YY	1400
		PHENOLIC	04, 09, 60, 57			43PH80JB##19YY	44PH80JB##19YY	1400
		HIGH-TEMP PHENOLIC	04, 09, 60, 90			43HT80JQ##19YY	44HT80JQ##19YY	1100
		POLY MAXROK™	04, 09, 48, 60, 57	G, K		43MU80J+##19YY	44MU80J+##19YY	1400
		POLYON AL™	04, 09, 48, 60, 57	N, R		43PA80J+##19YY	44PA80J+##19YY	1500
		DW-BLACK				43DW80JLT319YY	44DW80JLT319YY	750
		DW-RED				43DW80JRT319YY	44DW80JRT319YY	1100
		DW-BLUE				43DW80JBT319YY	44DW80JBT319YY	1500
		DW-GRAY				43DW80JGT319YY	44DW80JGT319YY	1500
		POLY-PRO™	04, 09, 48, 60, 63, 57		C, D, I, K, M, U, W	43PP80J+##19YY	44PP80J+##19YY	800
						43PP80JP4919YY	44PP80JP4919YY	900
						43PP80JH6319YY	44PP80JH6319YY	1000
		POLYMAC™	04, 09, 48, 60, 63, 57	I, M		43PM80J+##19YY	44PM80J+##19YY	1000
		POLYON™	04, 09, 60		G, V	43PU80JV6319YY	44PU80JV6319YY	1400
43PU80J+##19YY	44PU80J+##19YY							



# DURABLE SUPERIOR CASTERS®

43/44 – MEDIUM HEAVY DUTY SERIES – 1, 500LB

Wheel Diameter	Thread Width	Wheel Type	Available Bearing Options	+ Color	Replace + with a desired wheel color. Replace ## with desired wheel bearing.		Load Cap.
					43 Series Swivel Part #	44 Series Rigid Part #	
8	2	ENERGY SAVER POLYON™	04, 09, 60		43SW80JU##19YY	44SW80JU##19YY	1500
		POLYFLEXON™ CAST			43RP80JK6319YY	44RP80JK6319YY	1000
		POLYFLEXON™		N, O	43UA80J+6419YY	44UA80J+6419YY	1200
		D-POLYON			43UD80JL6419YY	44UD80JL6419YY	1200
		ULTRAFLEX™			43UX80JO6419YY	44UX80JO6419YY	1200
		CHAMPION			43CP80JN6419YY	44CP80JN6419YY	1500
		DURALASTOMER™	09, 60, 63, 57		43SU80JL##19YY	44SU80JL##19YY	1000
		SUPER ELASTOMER			43EE80JI6019YY	44EE80JI6019YY	1250
		ERGOLASTOMER™	04, 09, 73, 64, 57		43HU80JI##19YY	44HU80JI##19YY	1500
		SEMI-STEEL	04, 09		43SS80JS##19YY	44SS80JS##19YY	1400
		HEAVY DUTY IRON	04, 09, 63		43HS80JS##19YY	44HS80JS##19YY	1500
		DUCTILE	04, 09, 63, 73, B1, B5		43DS80JR##19YY	44DS80JR##19YY	1500
		ENERGY SAVER DUCTILE™	04, 09, B1, B5		43CD80JR##19YY	44CD80JR##19YY	1500
		FORGED STEEL	04, 09, 73, 63, B5, B1		43FS80JS##19YY	44FS80JS##19YY	1500
IRON V-GROOVE	04, 09		43VG80JT##19YY	44VG80JT##19YY	1200		
8	2	YOKE ONLY			43ZZ81JZ8319YY	44ZZ81JZ8319YY	
		NEO-ENERGIZER™	04, 09, 60		43EN81JB##19YY	44EN81JB##19YY	600
		NOMADIC™	04, 09, 48, 60, 57	B, I	43NM81J+##19YY	44NM81J+##19YY	700
		RUBBER ON NYLON	04, 09, 48, 60, 57		43NR81JB##19YY	44NR81JB##19YY	600
		DURA-CUSHION™	04, 09, 63	X, Z	43BC81J+##19YY	44BC81J+##19YY	450
		ECO-RUBBER	53, P3		43SN81UC##19YY	44SN81UC##19YY	450
		RUBBER ON ALUMINUM	04, 09, 48, 60, 57		43RA81JB##19YY	44RA81JB##19YY	600
		MOLD-ON RUBBER	04, 09, 48, 60, 57		43RS81JB##19YY	44RS81JB##19YY	600
		SUPREME RUBBER	63, 73		43RH81JS##19YY	44RH81JS##19YY	800
		THERMO-PRO™	04, 09, 60, 63, 48, 57	A, I, T, X, Y, Z,	43TP81J+##19YY	44TP81J+##19YY	600
		POLYOLEFIN	04, 09, 60, 53, P3, 48, 57, 90	B, E	43PO81J+##19YY	44PO81J+##19YY	900
		NYLON	04, 09, 60, 48, 57		43NY81JE##19YY	44NY81JE##19YY	1100
		IRONMAN	65, 73		43NX81JB##19YY	44NX81JB##19YY	1500
		ROKHARD™	04, 09, 48, 60, 57		43HI81JB##19YY	44HI81JB##19YY	1100
		BRIMSTONE®	04, 09, 60, 90		43GN81JQ##19YY	44GN81JQ##19YY	1200
		EPOXY	04, 09, 90		43OV81JQ##19YY	44OV81JQ##19YY	1200
		MAXROK™	04, 09, 48, 60, 57		43MA81JB##19YY	44MA81JB##19YY	1400
		PHENOLIC	04, 09, 60, 57		43PH81JB##19YY	44PH81JB##19YY	1400
		HIGH-TEMP PHENOLIC	04, 09, 60, 90		43HT81JQ##19YY	44HT81JQ##19YY	1100
		POLY MAXROK™	04, 09, 48, 60, 57	G, K	43MU81J+##19YY	44MU81J+##19YY	1400
		POLYON AL™	04, 09, 48, 60, 57	N, R	43PA81J+##19YY	44PA81J+##19YY	1500
		DW-BLACK			43DW81JLT319YY	44DW81JLT319YY	750
		DW-RED			43DW81JRT319YY	44DW81JRT319YY	1100
		DW-BLUE			43DW81JBT319YY	44DW81JBT319YY	1500
		DW-GRAY			43DW81JGT319YY	44DW81JGT319YY	1500
		POLY-PRO™	04, 09, 48, 60, 63, 57	C, D, I, K, M, U, W	43PP81J+##19YY	44PP81J+##19YY	800
					43PP81JP4919YY	44PP81JP4919YY	900
		POLYADIC™	04, 09, 48, 60, 63, 57	I, M	43PP81JH6319YY	44PP81JH6319YY	1000
					43PM81J+##19YY	44PM81J+##19YY	1000
		POLYON™	04, 09, 60	G, V	43PU81JV6319YY	44PU81JV6319YY	1400
					43PU81J+##19YY	44PU81J+##19YY	1400
		ENERGY SAVER POLYON™	04, 09, 60		43SW81JU##19YY	44SW81JU##19YY	1500
		POLYFLEXON™ CAST			43RP81JK6319YY	44RP81JK6319YY	1000
		POLYFLEXON™		N, O	43UA81J+6419YY	44UA81J+6419YY	1200
		D-POLYON			43UD81JL6419YY	44UD81JL6419YY	1200
		ULTRAFLEX™			43UX81JO6419YY	44UX81JO6419YY	1200
		CHAMPION			43CP81JN6419YY	44CP81JN6419YY	1500
		DURALASTOMER™	09, 60, 63, 57		43SU81JL##19YY	44SU81JL##19YY	1000
		SUPER ELASTOMER			43EE81JI6019YY	44EE81JI6019YY	1250
		ERGOLASTOMER™	04, 09, 73, 64, 57		43HU81JI##19YY	44HU81JI##19YY	1500
		SEMI-STEEL	04, 09		43SS81JS##19YY	44SS81JS##19YY	1400
		HEAVY DUTY IRON	04, 09, 63		43HS81JS##19YY	44HS81JS##19YY	1500
DUCTILE	04, 09, 63, 73, B1, B5		43DS81JR##19YY	44DS81JR##19YY	1500		
ENERGY SAVER DUCTILE™	04, 09, B1, B5		43CD81JR##19YY	44CD81JR##19YY	1500		
FORGED STEEL	04, 09, 73, 63, B5, B1		43FS81JS##19YY	44FS81JS##19YY	1500		
IRON V-GROOVE	04, 09		43VG81JT##19YY	44VG81JT##19YY	1200		
8	2-1/2	MOLD-ON RUBBER	06		43RS80KB0619YY	44RS80KB0619YY	800
		NEO-ENERGIZER™	23		43EN80KB2D19YY	44EN80KB2D19YY	1400
		PHENOLIC	06		43PH80KB0619YY	44PH80KB0619YY	1500
		POLYON™	06		43PU80KV0619YY	44PU80KV0619YY	1500
10	2-1/2	SEMI-STEEL	06		43SS80KS0619YY	44SS80KS0619YY	1500
		MOLD-ON RUBBER	06		43RS10KB0619YY	44RS10KB0619YY	1000
		PHENOLIC	06		43PH10KB0619YY	44PH10KB0619YY	1500
		POLYON™	06		43PU10KV0619YY	44PU10KV0619YY	1500
SEMI-STEEL	06		43SS10KS0619YY	44SS10KS0619YY	1500		



# 81/82 – HEAVY DUTY, ECONOMY INDUSTRIAL SERIES – 1,800 LB



- 3/8" thick cold rolled steel stamped construction
- 3/4" heavy duty kingbolt
- 3/8" thick steel legs
- Zinc-plated finish
- 3/4" axle bolt with grease fitting



FASTENING PATTERN			
Plate Code	Overall Size	Bolt Holes Pattern	Mounting Bolt Size
19	4-1/2 X 6-1/4	2-7/16 X 4-15/16 SLOTTED TO 3-3/8 X 5-1/4	1/2

OTHER OPTIONS		
4-Position Lock (P)	Toe Guard	4-Position Lock Bolt-on. Order Separately Part # 4PSL43

Wheel Diameter	Tread Width	Wheel Type	Load Capacity	Add options by replacing YY in part # with option designators.			Color	Overall Height	Swivel Radius
				81 Series Swivel Casters Part # To order Rigid casters change prefix 81 to 82.					
				Roller Bearings 23, 24	Tapered Bearing 70	Sealed Precision BB 65			
5	2-1/2	YOKE ONLY		81ZZ50KZ8819YY				6-1/2	4-3/4
		POLYON™	1400	81PU50KG2319YY					
		DUCTILE STEEL	1800	81DS50KR2319YY					
6	2-1/2	YOKE ONLY		81ZZ60KZ8819YY				7-1/2	5-1/4
		RUBBER MOLD-ON IRON	600	81RS60KB2319YY					
		PHENOLIC	1600	81PH60KB2319YY				G, V	
		POLYON™	1600	81PU60K+2319YY					
		ENERGY SAVER POLYON™	1700	81SW60KU2319YY	81SW60KU7019YY				
		ERGOLASTOMER™	1800			81HU60KI6519YY			
		IRONMAN™	1800			81NX60KB6519YY			
		SEMI-STEEL	1800	81SS60KS2319YY					
		DUCTILE STEEL	1800	81DS50KR2319YY	81DS60KR7019YY				
		ENERGY SAVER DUCTILE™	1800	81CD60KR2319YY	81CD60KR7019YY				
		IRON V-GROOVE	1800	81VG60KT2319YY					
		DUCTILE IRON V-GROOVE	1800	81DV60KT2319YY	81DV60KT7019YY				
8	2-1/2	YOKE ONLY		81ZZ80KZ8819YY				10-1/8	6-1/4
		NEOPRENE ENERGIZER	1400	81EN80KB2319YY		81EN80KB8919YY			
		MOLD-ON RUBBER	850	81RS80KB2319YY					
		SUPREME RUBBER™	950			81RH80KS6519YY			
		CHAMPION™	1700			81CP80KN6719YY			
		PHENOLIC	1800	81PH80KB2319YY					
		POLYON™	1800	81PU80K+2319YY				G, V	
		ENERGY SAVER POLYON™	1800	81SW80KU2319YY	81SW80KU7019YY				
		ERGOLASTOMER™	1800			81HU80KI6519YY			
		SEMI-STEEL	1800	81SS80KS2319YY					
		DUCTILE	1800	81DS80KR2319YY	81DS80KR7019YY				
		ENERGY SAVER DUCTILE™	1800	81CD80KR2319YY	81CD80KR7019YY				
		IRON V-GROOVE	1800	81VG80KT2319YY					
DUCTILE IRON V-GROOVE	1800	81DV80KT2319YY	81DV80KT7019YY						
10	2-1/2	YOKE ONLY		81ZZ10KZ8819YY				11-1/2	7-1/4
		MOLD-ON RUBBER	1000	81RS10KB2319YY					
		PHENOLIC	1800	81PH10KB2319YY					
		POLYON™	1800	81PU10K+2319YY					
		ENERGY SAVER POLYON™	1800	81SW10KU2319YY	81SW10KU7019YY				
		SEMI-STEEL	1800	81SS10KS2319YY					
		DUCTILE	1800	81DS10KR2319YY	81DS10KR7019YY				

## 47/48 – MEDIUM HEAVY DUTY KINGPINLESS SERIES – 2,000 LB



- ASTM1045 steel hot forged and precisely machined raceway
- Hardened raceway for maximum of load capacity and life
- Optional extended swivel lead and overall heights are available
- Zinc-plated finish
- 1/2" axle

OTHER OPTIONS			
4-Position Lock (P)	Thread Guards (G)	Toe Guard	4-Position Lock Bolt-on. Order Separately Part # 4PSL27

FASTENING PATTERN			
Plate Code	Overall Size	Bolt Hole Pattern	Mounting Bolt size
19	4-1/2 X 6-1/4	2-7/16 X 4-15/16 SLOTTED TO 3-3/8 X 5-1/4	1/2

BRAKE OPTIONS		
Top Lock Brake (T)	A-Cam Brake (A)	Cam-Lock Brake (C)

WHEEL DIAMETER, OVER HEIGHTS, OFFSETS AND SWIVEL RADIUS				
<i>To order optional overall height, replace the standard wheel diameter designation with optional code. (Example: 47HU81JI6319YY)</i>				
Wheel Diameter	Designation Code	Overall Height	Offset	Swivel Radius
4	40	5-5/8	1-1/4	3-1/4
5	50	6-1/2	1-7/16	3-15/16
6	60	7-1/2	1-9/16	4-9/16
8	80	10-1/8	2-3/4	6-3/4
8	81	9-1/2	2-1/4	6-1/4

### 47/48 – MEDIUM HEAVY DUTY KINGPINLESS SERIES – 2,000 LB

Wheel Dia.	Tread Width	Wheel Type	Load Cap.	When multiple bearing choices exist, replace ## with desired bearing code.					+ Color
				47 Series Swivel Caster Part #					
				To order rigid casters, change part # prefix 47 to 48.					
				Roller Bearing 04	Caged Roller Bearing 09	Tapered Bearing 73	Sealed Precision BB 48, 63, 63, H7960	Delrin Bronze & Plain 11, 12, 56, 57, 88, 96, B1, B5	
4	2	YOKE ONLY		47ZZ40JZ8319YY					
		NEO-ENERGIZER™	500	47EN40JB0419YY	47EN40JB0919YY		47EN40JB6019YY		
		NOMADIC™	400	47NM40J+0419YY	47NM40J+0919YY		47NM40J+4819YY		I, B
		RUBBER ON NYLON	400	47NR40JB0419YY	47NR40J0919YY		47NR4JB4819YY	47NR40JB##19YY	
		RUBBER ON ALUMINUM	400	47RA40JB0419YY	47RA40JB0919YY			47RA40JB##19YY	
		LOW PROFILE RUBBER	300	47LP40JB0419YY	47LP40JB0919YY				
		MOLD-ON RUBBER	400	47RS40JB0419YY	47RS40JB0919YY				
		THERMO-PRO™	300	47TP40J+0419YY	47TP40J+0919YY		47TP40J+4819YY	47TP40J+##19YY	I, T, X, Y
		POLYOLEFIN	500	47PO40JB0419YY	47PO40JB0919YY		47PO40JB6019YY	47PO40JB##19YY	
		NYLON	800	47NY40JE0419YY	47NY40JE0919YY		47NY60JE6019YY		
		IRONMAN™	1500		47NX40JB0919YY		47NX40JB6519YY		
		ROKHARD™	800	47HI40JB0419YY	47HI40JB0919YY		47HI40JB6019YY	47HI40JB##19YY	
		BRIMSTONE®	800	47GN40JQ0419YY	47GN40JQ0919YY		47GN40JQ6019YY	47GN40JQ##19YY	
		EPOXY	800	47OV40JQ0419YY	47OV40JQ0919YY				
		MAXROK™	800	47MA40JB0419YY	47MA40JB0919YY		47MA40JB6019YY	47MA40JB##19YY	
		PHENOLIC	800	47PH40JB0419YY	47PH40JB0919YY		47PH40JB6019YY	47PH40JB##19YY	
		PHENOLIC (STRAIGHT SIDED)	1000	47PH40TB0419YY	47PH40TB0919YY				
		HIGH-TEMP PHENOLIC	600	47HT40JQ0419YY	47HT40JQ0919YY			47HT40JQ##19YY	
		POLYON MAXROK™	700	47MU40J+0419YY	47MU40J+0919YY		47MU40J+6319YY	47MU40J+##19YY	G, K
		POLYON AL™	800	47PA40J+0419YY	47PA40J+0919YY		47PA40J+6019YY	47PA40J+##19YY	N, R
DW-BLACK	470				47DW40JLT319YY				
DW-RED	650				47DW40JRT319YY				

47/48 – MEDIUM HEAVY DUTY KINGPINLESS SERIES – 2, 000 LB

Wheel Dia.	Tread Width	Wheel Type	Load Cap.	When multiple bearing choices exist, replace ## with desired bearing code.					+ Color
				47 Series Swivel Caster Part # To order rigid casters, change part # prefix 47 to 48.					
				Roller Bearing 04	Caged Roller Bearing 09	Tapered Bearing 73	Sealed Precision BB 48, 63, 63, H7960	Delrin Bronze & Plain 11, 12, 56, 57, 88, 96, B1, B5	
5	2	DW-BLUE	960				47DW40JBT319YY		
		DW-GRAY	1000				47DW40JGT319YY		
		POLY-PRO™	500	47PP40J+0419YY	47PP40J+0919YY		47PP40J+6019YY	47PP40J+##19YY	I, D, K, U, W
				47PP40JM0419YY	47PP40JM0919YY		47PP40JM6319YY	47PP40JM##19YY	
		POLYMADIC™	600	47PM40J+0419YY	47PM40J+0919YY		47PM40J+##19YY	47PM40J+##19YY	I, M
				47PU40J+0419YY	47PU40J+0919YY	47PU40JV7319YY	47PU40JV6319YY		
		POLYON™	800					47PU40J+##19YY	G, V
		ENERGY SAVER POLYON™	800	47SW40JU0419YY	47SW40JU0919YY	47SW40JU7319YY			
		POLYFLEXON™ CAST	700	47RP40JK0419YY	47RP40JK0919YY		47RP40JK4819YY	47RP40JK##19YY	
		POLYFLEXON™	900				47UA40J+6419YY		N, O
		D-POLYON™	900				47UD40JL6419YY		
		ULTRAFLEX™	900				47UX40JO6419YY		
		DURALASTOMER™	750		47SU40JL0919YY		47SU40JL6019YY	47SU40JL##19YY	
		SUPER ELASTOMER	1200				47EE40JI6019YY		
		ERGOLASTOMER™	1000	47HU40JI0419YY	47HU40JI0919YY	47HU40JI7319YY	47HU40JI6319YY	47HU40JI##19YY	
		SEMI-STEEL	700	47SS40JS0419YY	47SS40JS0919YY			47SS40JS##19YY	
		HEAVY DUTY IRON	900	47HS40JS0419YY	47HS40JS0919YY		47HS40JS6319YY		
		DUCTILE	1500	47DS40JR0419YY	47DS40JR0919YY	47DS40JR7319YY	47DS40JR6319YY		
		SOLID STEEL	1500		47MS40JS0917YY			47MS40JS##19YY	
		ENERGY SAVER DUCTILE™	1500	47CD40JR0419YY	47CD40JR0919YY				
		MAXROK™ V-GROOVE	800	47MV40JT0419YY	47MV40JT0919YY		47MV40JT6019YY	47MV40JT##19YY	
		IRON V-GROOVE	600	47VG40JT0419YY	47VG40JT0919YY				
		DUCTILE V-GROOVE	1500	47DV40JT0419YY	47DV40JT0919YY				
		YOKE ONLY		47ZZ50JZ8319YY					
		NEO-ENERGIZER™	550	47EN50JB0419YY	47EN50JB0919YY		47EN50JB6019YY		
		NOMADIC™	500	47NM50J+0419YY	47NM50J+0919YY		47NM50J+4819YY		I, B
		RUBBER ON NYLON	450	47NR50JB0419YY	47NR50JB0919YY		47NR50JB4819YY	47NR50JB##19YY	
		RUBBER ON ALUMINUM	500	47RA50JB0419YY	47RA50JB0919YY		47RA50JB6019YY	47RA50JB##19YY	
		MOLD-ON RUBBER	400	47RS50JB0419YY	47RS50JB0919YY				
		CUSHENDURE™	400				47GR50JB1919YY		
		THERMO-PRO™	350	47TP50J+0419YY	47TP50J+0919YY		47TP50J+6019YY	47TP50J+##19YY	I, T, X, Y
				47TP50J+0419YY	47TP50J+0919YY		47TP50J+6019YY	47TP50J+##19YY	
		POLYOLEFIN	650	47PO50JB0419YY	47PO50JB0919YY		47PO50JB6019YY	47PO50JB##19YY	
		NYLON	900	47NY50JE0419YY	47NY50JE0919YY		47NY50JE6019YY	47NY50JE##19YY	
		IRONMAN™	1500			47NX50JB7319YY	47NX50JB6519YY		
		ROKHARD™	1000	47HI50JB0419YY	47HI50JB0919YY		47HI50JB6019YY	47HI50JB##19YY	
		BRIMSTONE®	1000	47GN50JQ0419YY	47GN50JQ0919YY		47GN50JQ6019YY	47GN50JQ##19YY	
		EPOXY	1000	47OV50JQ0419YY	47OV50JQ0919YY				
		MAXROK™	1000	47MA50JB0419YY	47MA50JB0919YY		47MA50JB6019YY	47MA50JB##19YY	
		PHENOLIC	1000	47PH50JB0419YY	47PH50JB0919YY		47PH50JB6019YY	47PH50JB##19YY	
		HIGH-TEMP PHENOLIC	750	47HT50JQ0419YY	47HT50JQ0919YY			47HT50JQ##19YY	
		STEROLLIZER™	450				47SL50CB819YY		
		POLYON MAXROK™	1000	47MU50J+0419YY	47MU50J+0919YY		47MU50J+6319YY	47MU50J+##19YY	G, K
		POLYON AL™	900	47PA50J+0419YY	47PA50J+0919YY		47PA50J+6019YY	47PA50J+##19YY	N, R
		POLY-C	900	47PR50JL0419YY	47PR50JL0919YY		47PR50JL6019YY		
		DW-BLACK	550				47DW50JLT319YY		
		DW-RED	750				47DW50JRT319YY		
		DW-BLUE	1160				47DW50JBT319YY		
DW-GRAY	1200				47DW50JGT319YY				
POLY-PRO™	600	47PP50J+0419YY	47PP50J+0919YY		47PP50J+6019YY	47PP50J+##19YY	I, D, K, U, W		
		47PP50JM0419YY	47PP50JM0919YY		47PP50JM6319YY	47PP50JM##19YY			
POLYMADIC	750	47PM50JI0419YY	47PM50JI0919YY		47PM50JI##19YY	47PM50JI##19YY			
		47PU50J+0419YY	47PU50J+0919YY	47PU50JV7319YY	47PU50JV6319YY				
POLYON™	1100					47PU50J+##19YY	G, V		
ENERGY SAVER POLYON™	1300	47SW50JU0419YY	47SW50JU0919YY						
POLYFLEXON™ CAST	800	47RP50JK0419YY	47RP50JK0919YY		47RP50JK6319YY				
POLYFLEXON™	900				47UA50J+6419YY		N, O		
D-POLYON™	900				47UD50JL6419YY				
ULTRAFLEX™	900				47UX50JO6419YY				



# DURABLE SUPERIOR CASTERS®

47/48 – MEDIUM HEAVY DUTY KINGPINLESS SERIES – 2, 000 LB

Wheel Dia.	Tread Width	Wheel Type	Load Cap.	When multiple bearing choices exist, replace ## with desired bearing code.					+ Color
				47 Series Swivel Caster Part # To order rigid casters, change part # prefix 47 to 48.					
				Roller Bearing 04	Caged Roller Bearing 09	Tapered Bearing 73	Sealed Precision BB 48, 63, 63, H7960	Delrin Bronze & Plain 11, 12, 56, 57, 88, 96, B1, B5	
5	2	DURALASTOMER™	900		47SU50JL0919YY		47SU50JL6019YY	47SU50JL##19YY	
		ERGOLASTOMER™	1400	47HU50JI0419YY	47HU50JI0919YY	47HU50JI7319YY	47HU50JI6319YY	47HU50JI##19YY	
		SUPER ELASTOMER	1200				47EE60JI6019YY		
		SEMI-STEEL	1000	47SS50JS0419YY	47SS50JS0919YY			47SS50JS##19YY	
		HEAVY DUTY IRON	1200	47HS50JZ0419YY	47HS50JZ0919YY		47HS50JS8319YY		
		DUCTILE	1500	47DS50JR0419YY	47DS50JR0919YY	47DS50JR7319YY	47DS50JR6319YY		
		FORGED STEEL	1500	47FS50JS0419YY	47FS50JS0919YY			47FS50JS##19YY	
		ENERGY SAVER DUCTILE™	1500	47CD50JR0419YY	47CD50JR0919YY				
6	2	IRON V-GROOVE	900	47VG50JT0419YY	47VG50JT0919YY				
		YOKE ONLY		47ZZ60JZ8319YY					
		NEO-ENERGIZER™	600	47EN60JB0419YY	47EN60JB0919YY		47EN60JB6019YY		
		PNEUMATIC	200				47FP60JB6019YY		
		FOAM FILLED EVER-ROLL™	200				47FF60JB6019YY		
		NOMADIC™	600	47NM60J+0419YY	47NM60J+0919YY		47NM60J+4819YY		I, B
		RUBBER ON NYLON	550	47NR60JB0419YY	47NR60JB0919YY			47NR60JB##19YY	
		DURA-CUSHION™	350	47BC60J+0419YY	47BC60J+0919YY		47BC60J+6319YY	47BC60J+##19YY	X, Z
		ECO-RUBBER	350				47SN60JCP319YY		
		RUBBER ON ALUMINUM	550	47RA60JB0419YY	47RA60JB0919YY		47RA60JB6019YY	47RA80JB##19YY	
		MOLD-ON RUBBER	550	47RS60JB0419YY	47RS60JB0919YY				
		SUPREME RUBBER™	700			47RH60JS7319YY			
		THERMO-PRO™	500	47TP60J+0419YY	47TP60J+0919YY		47TP60J+6019YY	47TP60J+##19YY	I, T, X, Y
		POLYOLEFIN	700	47PO60JB0419YY	47PO60JB0919YY		47PO60JB6019YY	47PO60JB##19YY	
		NYLON	1000	47NY60JE0419YY	47NY60JE0919YY		47NY60JE6019YY	47NY60JE##19YY	
		IRONMAN™	1500			47NX60JB7319YY	47NX60JB6519YY		
		ROKHARD™	1200	47HI60JB0419YY	47HI60JB0919YY		47HI60JB6019YY	47HI60JB##19YY	
		BRIMSTONE®	1100	47GN60JQ0419YY	47GN60JQ0919YY		47GN60JQ6019YY	47GN60JQ##19YY	
		EPOXY	1100	47OV60JQ0419YY	47OV60JQ0919YY			47OV60JQ##19YY	
		MAXROK™	1200	47MA60JB0419YY	47MA60JB0919YY		47MA60JB6019YY	47MA60JB##19YY	
		PHENOLIC	1200	47PH60JB0419YY	47PH60JB0919YY		47PH60JB6019YY	47PH60JB##19YY	
		PHENOLIC (STRAIGHT SIDED)		47PH60TB0419YY	47PH60TB0919YY				
		HIGH-TEMP PHENOLIC	900	47HT60JQ0419YY	47HT60JQ0919YY			47HT60JQ##19YY	
		POLYON MAXROK™	1200	47MU60J+0419YY	47MU60J+0919YY		47MU60J+6319YY	47MU60J+##19YY	G, K
		POLYON AL™	1200	47BC60J+0419YY	47BC60J+0919YY		47PA60J+6019YY	47PA60J+##19YY	N, R
		POLYON-C	1200	47PR60JL0419YY	47PR60JL0919YY		47PR60JL6019YY		
		DW-BLACK	700				47DW60JLT319YY		
		DW-RED	960				47DW60JRT319YY		
		DW-BLUE	1400				47DW60JBT319YY		
		DW-GRAY	1440				47DW60JGT319YY		
		POLY-PRO™	720	47PP60J+0419YY	47PP60J+0919YY		47PP60J+##19YY	47PP60J+##19YY	I, D, H, K, M, U, W
			900				47PP60JP4919YY		
		POLYADIC	900	47PM60J+0419YY	47PM60J+0919YY		47PP60JH6319YY		
		POLYON™	1200			47PU60JV7319YY	47PM60J+##19YY	47PM60J+##19YY	I, M
				47PU60J+0419YY	47PU60J+0919YY		47PU60JV6319YY		
								47PU60J+##19YY	G, V
		ENERGY SAVER POLYON™	1400	47SW60JU0419YY	47SW60JU0919YY	47SW60JU7319YY	47SW60JU6319YY		
		POLYFLEXON™ CAST	900	47RP60JK0419YY	47RP60JK0919YY		47RP60JK4819YY		
		POLYFLEXON™	1000				47UA60J+6419YY		N, O
		D-POLYON™	1000				47UD60JL6419YY		
ULTRAFLEX™	1000				47UX60JO6419YY				
CHAMPION™	1200				47CP60JN6419YY				
DURALASTOMER™	1000		47SU60JL0919YY		47SU60JL6019YY	47SU60JL##19YY			
SUPER ELASTOMER	1320				47EE60JI6019YY				
ERGOLASTOMER™	1700	47HU60JI0419YY	47HU60JI0919YY	47HU60JI7319YY	47HU60JI6319YY	47HU60JI##19YY			
SEMI-STEEL	1200	47SS60JS0419YY	47SS60JS0919YY			47SS60JS##19YY			
HEAVY DUTY IRON	1400	47HS60JX0419YY	47HS60JX0919YY		47HS60JS6319YY				
DUCTILE	2000	47DS60JR0419YY	47DS60JR0919YY	47DS60JR7319YY	47DS60JR6319YY				
ENERGY SAVER DUCTILE™	2000	47CD60JR0419YY	47CD60JR0919YY						
6	2	FORGED STEEL	2000	47FS60JS0419YY	47FS60JS0919YY	47FS60JS7319YY			
		IRON V-GROOVE	1000	47VG60JT0419YY	47VG60JT0919YY				
		DUCTILE V-GROOVE	1500	47DV60JT0419YY	47DV60JT0919YY		47DV60JT6319YY		



47/48 – MEDIUM HEAVY DUTY KINGPINLESS SERIES – 2, 000LB

Wheel Dia.	Tread Width	Wheel Type	Load Cap.	When multiple bearing choices exist, replace ## with desired bearing code.					+ Color
				47 Series Swivel Caster Part # To order rigid casters, change part # prefix 47 to 48.					
				Roller Bearing 04	Caged Roller Bearing 09	Tapered Bearing 73	Sealed Precision BB 48, 63, 63, H7960	Delrin Bronze & Plain 11, 12, 56, 57, 88, 96, B1, B5	
8	2	YOKE ONLY		47ZZ80JZ8319YY					
		NEO-ENERGIZER™	600	47EN80JB0419YY	47EN80JB0919YY		47EN80JB6019YY		
		NOMADIC™	700	47NM80J+0419YY	47NM80J+0919YY		47NM80J+4819YY		I, B
		RUBBER ON NYLON	600	47NR80JB0419YY	47NR80JB0919YY			47NR80JB##19YY	
		DURA-CUSHION™	450	47BC80J+0419YY	47BC80J+0919YY		47BC80J+6319YY	47BC80J+##19YY	X, Z
		ECO-RUBBER	450				47SN80UCP319YY		
		RUBBER ON ALUMINUM	600	47RA80JB0419YY	47RA80JB0919YY		47RA80JB6019YY	47RA80JB##19YY	
		MOLD-ON RUBBER	600	47RS80JB0419YY	47RS80JB0919YY				
		SUPREME RUBBER™	800			47RH80JS7319YY			
		THERMO-PRO™	600	47TP80J+0419YY	47TP80J+0919YY		47TP80J+6019YY	47TP80J+##19YY	I, T, X, Y
		POLYOLEFIN	900	47PO80J+0419YY	47PO80J+0919YY		47PO80J+P319YY		B, E
		NYLON	1100	47NY80JE0419YY	47NY80JE0919YY		47NY80JE6019YY	47NY80JE##19YY	
		IRONMAN™	1500			47NX80JB7319YY	47NX80JB6519YY		
		ROKHARD™	1400	47HI80JB0419YY	47HI80JB0919YY		47HI80JB6019YY	47HI80JB##19YY	
		BRIMSTONE®	1200	47GN80JQ0419YY	47GN80JQ0919YY		47GN80JQ6019YY	47GN80JQ##19YY	
		EPOXY	1200	47OV80JQ0419YY	47OV80JQ0919YY			47OV80JQ##19YY	
		MAXROK™	1400	47MA80JB0419YY	47MA80JB0919YY		47MA80JB6019YY	47MA80JB##19YY	
		PHENOLIC	1400	47PH80JB0419YY	47PH80JB0919YY		47PH80JB6019YY	47PH80JB##19YY	
		HIGH-TEMP PHENOLIC	1100	47HT80JQ0419YY	47HT80JQ0919YY			47HT80JQ##19YY	
		POLY MAXROK™	1400	47MU80J+0419YY	47MU80J+0919YY		47MU80J+6319YY	47MU80J+##19YY	G, K
		POLYON AL™	1500	47PA80J+0419YY	47PA80J+0919YY		47PA80J+6019YY	47PA80J+##19YY	N, R
		DW-BLACK	1400				47DW80JLT319YY		
		DW-RED	1500				47DW80JRT319YY		
		DW-BLUE	1500				47DW80JBT319YY		
		DW-GRAY	1500				47DW80JGT319YY		
		POLY-PRO™	800	47PP80J+0419YY	47PP80J+0919YY		47PP80J+##19YY	47PP80J+##19YY	I, D, H, K, M, U, W
			1000				47PP80JP4919YY		
		POLYMADIC™	1000	47PM80J+0419YY	47PM80J+0919YY		47PP80JH6319YY		
							47PM80J+##19YY	47PM80J+##19YY	I, M
		POLYON™	1400	47PU80J+0419YY	47PU80J+0919YY	47PU80JV7319YY	47PU80JV6319YY		
								47PU80J+##19YY	
		ENERGY SAVER POLYON™	1500	47SW80JU0419YY	47SW80JU0919YY	47SW80JU7319YY	47SW80JU6319YY		
		POLYFLEXON™ CAST	1000				47RP80JK6319YY		
		POLYFLEXON™	1200				47UA80J+6319YY		N, O
		D-POLYON™	1200				47UD80JL6419YY		
		ULTRAFLEX™	1200				47UX80JO6419YY		
		CHAMPION™	1500				47CP60JN6419YY		
		SUPER ELASTOMER	1250				47EE80JI6019YY		
		DURALASTOMER™	1000		47SU80JL0919YY		47SU80JL6019YY	47SU80JL##19YY	
		ERGOLASTOMER™	2000	47HU80JI0491YY	47HU80JI0919YY	47HU80JI7319YY	47HU80JI6319YY	47HU80JI##19YY	
SEMI-STEEL	1400	47SS80JS0419YY	47SS80JS0919YY			47SS80JS##19YY			
HEAVY DUTY IRON	1600	47HS80JS0419YY	47HS80JS0919YY		47HS80JS6319YY				
DUCTILE	2000	47DS80JR0419YY	47DS80JR0919YY	47DS80JR7319YY	47DS80JR6319YY				
ENERGY SAVER DUCTILE™	2000	47CD80JR0419YY	47CD80JR0919YY						
FORGED STEEL	2000	47FS80JS0419YY	47FS80JS0919YY	47FS80JS7319YY					
IRON V-GROOVE	1200	47VG80JT0419YY	47VG80JT0919YY						

## 51/52 – MEDIUM HEAVY DUTY FORGED SERIES – 2,000 LB



### FASTENING PATTERN

Plate Code	Overall Size	Bolt Hole Pattern	Mounting Bolt Size
19	4-1/2 X 6-1/4	2-7/16 X 4-15/16 TO 3-3/8 X 5-1/4	1/2

### WHEEL DIAMETER, OVER HEIGHTS AND SWIVEL RADIUS

Wheel Diameter	Denotation Code	Overall Height	Swivel Radius
4	40	5-5/8	3-9/16
5	50	6-1/2	4-1/2
6	60	7-1/2	5-3/16
8	80	10-1/8	6-3/8
	81	9-1/2	6-3/8
10	10	11-1/2	7-1/4

TLB not available

- ASTM1045 drop forged construction.
- Precisely machined and hardened double ball raceways
- 3/4" heat treated kingpin
- 1/4" thick legs double welded

### BRAKE OPTIONS

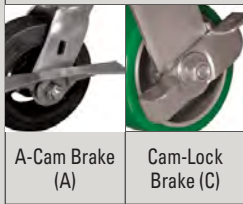

### OTHER OPTIONS



## 51/52 – MEDIUM HEAVY DUTY FORGED SERIES – 2000 LB

Wheel Diameter	Thread Width	Wheel Type	Available Bearing Options	+ Color	Replace + with a desired wheel color. Replace ## with desired wheel bearing.		Load Cap.	
					51 Series Swivel Caster Part #	52 Series Rigid Caster Part #		
4	2	YOKE ONLY				51ZZ40JZ8319YY	52ZZ40JZ8319YY	
		NEO-ENERGIZER™	04, 09, 60			51EN40JB##19YY	52EN40JB##19YY	500
		NOMADIC™	04, 09, 60, 48, 57	I, B		51NM40J+##19YY	52NM40J+##19YY	400
		RUBBER ON NYLON	04, 09, 60, 48, 57			51NR40JB##19YY	52NR40JB##19YY	400
		RUBBER ON ALUMINUM	04, 09, 60, 48, 57			51RA40JB##19YY	52RA40JB##19YY	400
		LOW PROFILE RUBBER				51LP40JB0419YY	52LP40JB0419YY	300
		MOLD-ON RUBBER	04, 09, 60, 48, 57			51RS40JB##19YY	52RS40JB##19YY	400
		THERMO-PRO™	04, 09, 60, 63, 48, 57	A, T, Y		51TP40J+##19YY	52TP40J+##19YY	300
		POLYOLEFIN	04, 09, 60, 63, 48, 57	B, E		51P040J+##19YY	52P040J+##19YY	500
		NYLON	04, 09, 60, 63, 48, 57			51NY40JE##19YY	52NY40JE##19YY	800
		IRONMAN	04, 09, 65, 73			51NX40JB##19YY	52NX40JB##19YY	2000
		ROK HARD™	04, 09, 60, 63, 48, 57			51HI40JB##19YY	52HI40JB##19YY	800
		BRIMSTONE®	04, 09, 90			51GN40JQ##19YY	52GN40JQ##19YY	800
		EPOXY	04, 09, 90			51OV40JQ##19YY	52OV40JQ##19YY	800
		MAXROK™	04, 09, 60, 63, 48, 57			51MA40JB##19YY	52MA40JB##19YY	800
		PHENOLIC	04, 09, 60, 63, 48, 57			51PH40JB##19YY	52PH40JB##19YY	800
		PHENOLIC (STRAIGHT SIDED)	04, 09, 60, 57, 12			51PH40TB##19YY	52PH40TB##19YY	1000
		HIGH-TEMP PHENOLIC	04, 09, 90			51HT40JQ##19YY	52HT40JQ##19YY	600
		POLYON MAXROK™	04, 09, 60, 63, 48, 57	G, K		51MU40J+##19YY	52MU40J+##19YY	700
		POLY AL™	04, 09, 60, 63, 48, 57	N, R		51PA40J+##19YY	52PA40J+##19YY	800
		DW-BLACK				51DW40JLT319YY	52DW40JLT319YY	420
		DW-RED				51DW40JRT319YY	52DW40JRT319YY	650
		DW-BLUE				51DW40JBT319YY	52DW40JBT319YY	960
		DW-GRAY				51DW40JGT319YY	52DW40JGT319YY	1000
		POLY-PRO™	04, 09, 60, 63, 48, 57	D, K, M, U, W		51PP40J+##19YY	52PP40J+##19YY	500
						51PP40JP4919YY	52PP40JP4919YY	600
		POLY MADIC™	04, 09, 60, 63, 48, 57	I, M		51PM40J+##19YY	52PM40J+##19YY	600
		POLYON™	04, 09, 60	G, V		51PU40J+##19YY	52PU40J+##19YY	800
						51PU40JV6319YY	52PU40JV6319YY	800
		ENERGY SAVER POLYON™	04, 09, 60, 73			51SW40JU##19YY	52SW40JU##19YY	800
		POLYFLEXON™ CAST	04, 09, 60, 63, 48, 57			51RP40JK##19YY	52RP40JK##19YY	700
		POLYFLEXON™		N, O		51UA40J+6419YY	52UA40J+6419YY	900
D-POLYON				51UD40JL6419YY	52UD40JL6419YY	900		

\*Change wheel denotation for optional overall height or swivel lead.

51/52 – MEDIUM HEAVY DUTY FORGED SERIES – 2000 LB

Wheel Diameter	Thread Width	Wheel Type	Available Bearing Options	+ Color	Replace + with a desired wheel color. Replace ## with desired wheel bearing.		Load Cap.
					51 Series Swivel Caster Part #	52 Series Rigid Caster Part #	
4	2	ULTRAFLEX™			51UX40J06419YY	52UX40J06419YY	900
		DURALASTOMER™	09, 60, 57		51SU40JL##19YY	52SU40JL##19YY	750
		SUPER ELASTOMER			51EE40JI6019YY	52EE40JI6019YY	1200
		ERGOLASTOMER™	04, 09, 73, 64, 57		51HU40JI##19YY	52HU40JI##19YY	1000
		SEMI-STEEL	04, 09		51SS40JS##19YY	52SS40JS##19YY	700
		HEAVY DUTY IRON	04, 09, 63		51HS40JS##19YY	52HS40JS##19YY	900
		DUCTILE	04, 09, 63, 73		51DS40JR##19YY	52DS40JR##19YY	2000
		SOLID STEEL	09, B1, B5		51MS40JS##19YY	52MS40JS##19YY	2000
		ENERGY SAVER DUCTILE™	04, 09, B1, B5		51CD40JR##19YY	52CD40JR##19YY	2000
		MAXROK™ V-GROOVE	04, 09, 60, 57		51MV40JT##19YY	52MV40JT##19YY	800
		IRON V-GROOVE	04, 09		51VG40JT##19YY	52VG40JT##19YY	600
		DUCTILE V-GROOVE	04, 09, B1, B5		51DV40JT##19YY	52DV40JT##19YY	2000
		5	2	YOKE ONLY			51ZZ50JZ8319YY
NEO-ENERGIZER™	04, 09, 60				51EN50JB##19YY	52EN50JB##19YY	550
NOMADIC™	04, 09, 48, 60, 57			B, I	51NM50J+##19YY	52NM50J+##19YY	500
RUBBER ON NYLON	04, 09, 48, 60, 57				51NR50JB##19YY	52NR50JB##19YY	450
RUBBER ON ALUMINUM	04, 09, 48, 60, 57				51RA50JB##19YY	52RA50JB##19YY	500
MOLD-ON RUBBER	04, 09, 60, 48, 57				51RS50JB##19YY	52RS50JB##19YY	400
CUSHENDURE™					51GR50JB1919YY	52GR50JB1919YY	400
THERMO-PRO™	04, 09, 60, 48, 63, 57			A, I, T, X, Y, Z	51TP50J+##19YY	52TP50J+##19YY	350
POLYOLEFIN				B, E	51PO50J+##19YY	52PO50J+##19YY	650
NYLON	04, 09, 60, 48, 53, P3, 57				51NY50JE##19YY	52NY50JE##19YY	900
IRONMAN	65, 73				51NX50JB##19YY	52NX50JB##19YY	2000
ROKHARD™	04, 09, 48, 60, 57				51HI50JB##19YY	52HI50JB##19YY	900
BRIMSTONE®	04, 09, 60, 90				51GN50JQ##19YY	52GN50JQ##19YY	1000
EPOXY	04, 09, 90				51OV50JQ##19YY	52OV50JQ##19YY	1000
MAXROK™	04, 09, 60, 48, 57				51MA50JB##19YY	52MA50JB##19YY	1000
PHENOLIC	04, 09, 60, 48, 57, 90				51PH50JB##19YY	52PH50JB##19YY	1000
H-TEMP PHENOLIC	04, 09, 90				51HT50JQ##19YY	52HT50JQ##19YY	750
STEROLLIZER™					51SL50JCB819YY	52SL50JCB819YY	450
POLYON MAXROK™	04, 09, 48, 60, 57			G, K	51MU50J+##19YY	52MU50J+##19YY	1000
POLYON AL™	04, 09, 48, 60, 57			N, R	51PA50J+##19YY	52PA50J+##19YY	900
POLYON - C	04, 09, 48, 60, 57, 12				51PR50JL##19YY	52PR50JL##19YY	900
DW-BLACK					51DW50JLT319YY	52DW50JLT319YY	550
DW-RED					51DW50JRT319YY	52DW50JRT319YY	750
DW-BLUE					51DW50JBT319YY	52DW50JBT319YY	1160
DW-GRAY					51DW50JGT319YY	52DW50JGT319YY	1200
POLY-PRO™	04, 09, 48, 60, 63, 57			B, C, D, K, U, M, W	51PP50J+##19YY	52PP50J+##19YY	600
					51PP50JP4919YY	52PP50JP4919YY	700
POLYADIC™	04, 09, 48, 60, 63, 57			I, M	51PP50JH6319YY	52PP50JH6319YY	
					51PM50J+##19YY	52PM50J+##19YY	750
POLYON™	04, 09, 60, 48			G, V	51PU50JV6319YY	52PU50JV6319YY	1100
					51PU50J+##19YY	52PU50J+##19YY	1100
ENERGY SAVER POLYON™	04, 09, 60, 48				51SW50JU##19YY	52SW50JU##19YY	1300
POLYFLEXON™ CAST	04, 09, 60, 48				51RP50JK##19YY	52RP50JK##19YY	800
POLYFLEXON™				N, O	51UA50J+6419YY	52UA50J+6419YY	900
D-POLYON					51UD50JL6419YY	52UD50JL6419YY	900
ULTRAFLEX™					51UX50J06419YY	52UX50J06419YY	900
DURALASTOMER™	09, 60, 57				51SU50JL##19YY	52SU50JL##19YY	900
SUPER ELASTOMER					51EE60JI6019YY	52EE60JI6019YY	1200
ERGOLASTOMER™	04, 09, 73, 64, 57				51HU50JI##19YY	52HU50JI##19YY	1400
SEMI-STEEL	04, 09				51SS50JS##19YY	52SS50JS##19YY	1000
HEAVY DUTY IRON	04, 09, 63				51HS50JS##19YY	52HS50JS##19YY	1200
DUCTILE	04, 09, 73, 63, B1, B5				51DS50JR##19YY	52DS50JR##19YY	2000
FORGED STEEL	02, 09, B5, B1		51FS50JS##19YY	52FS50JS##19YY	2000		
ENERGY SAVER DUCTILE™	04, 09, B1, B5		51CD50JR##19YY	52CD50JR##19YY	2000		
IRON V-GROOVE	04, 09		51VG50JT##19YY	52VG50JT##19YY	900		
6	2	YOKE ONLY			51ZZ60JZ8319YY	52ZZ60JZ8319YY	
		NEO-ENERGIZER™	04, 09, 60		51EN60JB##19YY	52EN60JB##19YY	600
		PNEUMATIC			51FP60JB6019YY	52FP60JB6019YY	200
		FOAM FILLED			51FF60JB6019YY	52FF60JB6019YY	200
		EVER-ROLL™		B, I	51ER60J+6019YY	52ER60J+6019YY	200
		NOMADIC™	04, 09, 48, 60, 57		51NM60JB##19YY	52NM60JB##19YY	600
		RUBBER ON NYLON	04, 09, 48, 60, 57		51NR60JB##19YY	52NR60JB##19YY	550
		DURA-CUSHION™	04, 09, 63	X, Z	51BC60J+##19YY	52BC60J+##19YY	350
		ECO-RUBBER	53, P3		51SN60JC##19YY	52SN60JC##19YY	350
		RUBBER ON ALUMINUM	04, 09, 48, 60, 57		51RA60JB##19YY	52RA60JB##19YY	550
		LOW PROFILE RUBBER			51LP60JB1419YY	52LP60JB0419YY	600
		MOLD-ON RUBBER	04, 09, 48, 60, 57		51RS60JB##19YY	52RS60JB##19YY	550

\*Change wheel denotation for optional overall height or swivel lead.



# DURABLE SUPERIOR CASTERS®

51/52 – MEDIUM HEAVY DUTY FORGED SERIES – 2000 LB

Wheel Diameter	Thread Width	Wheel Type	Available Bearing Options	+ Color	Replace + with a desired wheel color. Replace ## with desired wheel bearing.		Load Cap.
					51 Series Swivel Caster Part #	52 Series Rigid Caster Part #	
6	2	SUPREME RUBBER	63, 73		51RH60JS##19YY	52RH60JS##19YY	700
		THERMO-PRO™	04, 09, 60, 63, 48, 57	A, I, T, X, Y, Z	51TP60J+##19YY	52TP60J+##19YY	500
		POLYOLEFIN	04, 09, 60, 53, P3, 48, 57	B, E	51P060J+##19YY	52P060J+##19YY	700
		NYLON	04, 09, 48, 60, 57		51NY60JE##19YY	52NY60JE##19YY	1000
		IRONMAN			51NX60JB6519YY	52NX60JB6519YY	2000
		ROKHARD™	04, 09, 48, 60, 57		51HI60JB##19YY	52HI60JB##19YY	1000
		BRIMSTONE®	04, 09, 60, 90		51GN60JQ##19YY	52GN60JQ##19YY	1100
		EPOXY	04, 09, 90		51OV60JQ##19YY	52OV60JQ##19YY	1100
		MAXROK™	04, 09, 60, 48, 57		51MA60JB##19YY	52MA60JB##19YY	1200
		PHENOLIC	04, 09, 60, 48, 57		51PH60JB##19YY	52PH60JB##19YY	1200
		PHENOLIC (STRAIGHT SIDED)			51PH60TB##19YY	52PH60TB##19YY	1500
		HIGH-TEMP PHENOLIC	04, 09, 90		51HT60JQ##19YY	52HT60JQ##19YY	1000
		POLY MAXROK™	04, 09, 60, 48, 57	G, K	51MU60J+##19YY	52MU60J+##19YY	1100
		POLYON AL™	04, 09, 48, 60, 57	N, R	51PA60J+##19YY	52PA60J+##19YY	1100
		POLYON-C	04, 09, 48, 60, 57, 12		51PR60JL##19YY	52PR60JL##19YY	1200
		DW-BLACK			51DW60JLT319YY	52DW60JLT319YY	700
		DW-RED			51DW60JRT319YY	52DW60JRT319YY	960
		DW-BLUE			51DW60JBT319YY	52DW60JBT319YY	1400
		DW-GRAY			51DW60JGT319YY	52DW60JGT319YY	1440
		POLY-PRO™	04, 09, 48, 60, 57	D, I, K, M, W, U	51PP60J+##19YY	52PP60J+##19YY	720
					51PP60JP4919YY	52PP60JP4919YY	900
		POLYMADIC™	04, 09, 48, 60, 63, 57	I, M	51PM60J+##19YY	52PM60J+##19YY	900
					51PU60JV6319YY	52PU60JV6319YY	1200
		POLYON™	04, 09, 60	G, V	51PU60J+##19YY	52PU60J+##19YY	
					51SW60JU##19YY	52SW60JU##19YY	1400
		ENERGY SAVER POLYON™	04, 09, 63, 73		51SW60JU##19YY	52SW60JU##19YY	1400
		POLYFLEXON™ CAST	04, 09, 60, 48, 57		51RP60JK##19YY	52RP60JK##19YY	900
		POLYFLEXON™		N, O	51UA60J+6419YY	52UA60J+6419YY	900
		D-POLYON			51UD60JL6419Y	52UD60JL6419YY	900
		ULTRAFLEX™			51UX60JO6419YY	52UX60JO6419YY	900
		CHAMPION			51CP60JN6419YY	52CP60JN6419YY	1200
		DURALASTOMER™	09, 60, 57		51SU60JL##19YY	52SU60JL##19YY	1000
		SUPER ELASTOMER			51EE60JI6019YY	52EE60JI6019YY	1320
		ERGOLASTOMER™	04, 09, 73, 64, 57		51HU60JI##19YY	52HU60JI##19YY	1700
		SEMI-STEEL	04, 09		51SS60JS##19YY	52SS60JS##19YY	1200
		HEAVY DUTY IRON	04, 09, 63		51HS60JS##19YY	52HS60JS##19YY	1400
		DUCTILE	04, 09, 73, 63, B1, B5		51DS60JR##19YY	52DS60JR##19YY	2000
		ENERGY SAVER DUCTILE™	04, 09, B1, B5		51CD60JR##19YY	52CD60JR##19YY	2000
		FORGED STEEL	04, 09, 73, 63, B1, B5		51FS60JS##19YY	52FS60JS##19YY	2000
		IRON V-GROOVE	04, 09		51VG60JT##19YY	52VG60JT##19YY	1000
DUCTILE V-GROOVE	04, 09, B1, B5		51DV60JT##19YY	52DV60JT##19YY	2000		
6	2-1/2	YOKE ONLY			51ZZ60KZ8319YY	52ZZ60KZ8319YY	
		MOLD-ON RUBBER			51RS60KB0619YY	52RS60KB0619YY	700
		PHENOLIC			51PH60KB0619YY	52PH60KB0619YY	1400
		POLYON™			51PU60KV0619YY	52PU60KV0619YY	1500
		SEMI-STEEL			51SS60KS0619YY	52SS60KS0619YY	1500
8	2	YOKE ONLY			51ZZ80JZ8319YY	52ZZ80JZ8319YY	
		NEO-ENERGIZER™	04, 09, 60		51EN80JB##19YY	52EN80JB##19YY	600
		NOMADIC™	04, 09, 48, 60, 57	B, I	51NM80J+##19YY	52NM80J+##19YY	700
		RUBBER ON NYLON	04, 09, 48, 60, 57		51NR80JB##19YY	52NR80JB##19YY	600
		DURA-CUSHION™	04, 09, 63	X, Z	51BC80J+##19YY	52BC80J+##19YY	450
		ECO-RUBBER	53, P3		51SN80UC##19YY	52SN80UC##19YY	450
		RUBBER ON ALUMINUM	04, 09, 48, 60, 57		51RA80JB##19YY	52RA80JB##19YY	600
		MOLD-ON RUBBER	04, 09, 48, 60, 57		51RS80JB##19YY	52RS80JB##19YY	600
		SUPREME RUBBER	63, 73		51RH80JS##19YY	52RH80JS##19YY	800
		THERMO-PRO™	04, 09, 60, 63, 48, 57	A, I, T, X, Y, Z	51TP80J+##19YY	52TP80J+##19YY	600
		POLYOLEFIN	04, 09, 60, 53, P3, 48, 57, 90	B, E	51P080J+##19YY	52P080J+##19YY	900
		NYLON	04, 09, 60, 48, 57		51NY80JE##19YY	52NY80JE##19YY	1100
		IRONMAN			51NX80JB6517YY	52NX80JB6527YY	2000
		ROKHARD™	04, 09, 48, 60, 57		51HI80JB##19YY	52HI80JB##19YY	1100
		BRIMSTONE®	04, 09, 60, 90		51GN80JQ##19YY	52GN80JQ##19YY	1200
		EPOXY	04, 09, 90		51OV80JQ##19YY	52OV80JQ##19YY	1200
		MAXROK™	04, 09, 48, 60, 57		51MA80JB##19YY	52MA80JB##19YY	1400
		PHENOLIC	04, 09, 60, 57		51PH80JB##19YY	52PH80JB##19YY	1400
		HIGH-TEMP PHENOLIC	04, 09, 60, 90		51HT80JQ##19YY	52HT80JQ##19YY	1100
		POLY MAXROK™	04, 09, 48, 60, 57	G, K	51MU80J+##19YY	52MU80J+##19YY	1400
		POLYON AL™	04, 09, 48, 60, 57	N, R	51PA80J+##19YY	52PA80J+##19YY	1500
		DW-BLACK			51DW80JLT319YY	52DW80JLT319YY	750
		DW-RED			51DW80JRT319YY	52DW80JRT319YY	1100

\*Change wheel denotation for optional overall height or swivel lead.





51/52 – MEDIUM HEAVY DUTY FORGED SERIES – 2000 LB

Wheel Diameter	Thread Width	Wheel Type	Available Bearing Options	+ Color	Replace + with a desired wheel color. Replace ## with desired wheel bearing.		Load Cap.	
					51 Series Swivel Caster Part #	52 Series Rigid Caster Part #		
8	2	DW-BLUE				51DW80JBT319YY	52DW80JBT319YY	1600
		DW-GRAY				51DW80JGT319YY	52DW80JGT319YY	1700
		POLY-PRO™	04, 09, 48, 60, 63, 57	C, D, I, K, M, U, W	51PP80J+##19YY	52PP80J+##19YY	800	
					51PP80JP4919YY	52PP80JP4919YY	900	
		POLYMADIC™	04, 09, 48, 60, 63, 57	I, M	51PP80JH6319YY	52PP80JH6319YY	1000	
					51PM80J+##19YY	52PM80J+##19YY	1000	
		POLYON™	04, 09, 60	G, V	51PU80JV6319YY	52PU80JV6319YY	1400	
					51PU80J+##19YY	52PU80J+##19YY		
		ENERGY SAVER POLYON™	04, 09, 60		51SW80JU##19YY	52SW80JU##19YY	1500	
		POLYFLEXON™ CAST			51RP80JK6319YY	52RP80JK6319YY	1000	
		POLYFLEXON™		N, O	51UA80J+6419YY	52UA80J+6419YY	1200	
		D-POLYON			51UD80JL6419YY	52UD80JL6419YY	1200	
		ULTRAFLEX™			51UX80JO6419YY	52UX80JO6419YY	1200	
		CHAMPION			51CP80JN6419YY	52CP80JN6419YY	1500	
		DURALASTOMER™	09, 60, 63, 57		51SU80JL##19YY	52SU80JL##19YY	1000	
		SUPER ELASTOMER			51EE80JI6019YY	52EE80JI6019YY	1250	
		ERGOLASTOMER™	04, 09, 73, 64, 57		51HU80JI##19YY	52HU80JI##19YY	2000	
		SEMI-STEEL	04, 09		51SS80JS##19YY	52SS80JS##19YY	1400	
		HEAVY DUTY IRON	04, 09, 63		51HS80JS##19YY	52HS80JS##19YY	1600	
		DUCTILE	04, 09, 63, 73, B1, B5		51DS80JR##19YY	52DS80JR##19YY	2000	
		ENERGY SAVER DUCTILE™	04, 09, B1, B5		51CD80JR##19YY	52CD80JR##19YY	2000	
		FORGED STEEL	04, 09, 73, 63, B5, B1		51FS80JS##19YY	52FS80JS##19YY	2000	
		IRON V-GROOVE	04, 09		51VG80JT##19YY	52VG80JT##19YY	1200	
				YOKE ONLY	51ZZ81JZ8319YY	52ZZ81JZ8319YY		
		NEO-ENERGIZER™	04, 09, 60		51EN81JB##19YY	52EN81JB##19YY	600	
		NOMADIC™	04, 09, 48, 60, 57	B, I	51NM81J+##19YY	52NM81J+##19YY	700	
		RUBBER ON NYLON	04, 09, 48, 60, 57		51NR81JB##19YY	52NR81JB##19YY	600	
		DURA-CUSHION™	04, 09, 63	X, Z	51BC81J+##19YY	52BC81J+##19YY	450	
ECO-RUBBER	53, P3		51SN81UC##19YY	52SN81UC##19YY	450			
RUBBER ON ALUMINUM	04, 09, 48, 60, 57		51RA81JB##19YY	52RA81JB##19YY	600			
MOLD-ON RUBBER	04, 09, 48, 60, 57		51RS81JB##19YY	52RS81JB##19YY	600			
SUPREME RUBBER	63, 73		51RH81JS##19YY	52RH81JS##19YY	810			
THERMO-PRO™	04, 09, 60, 63, 48, 57	A, I, T, X, Y, Z,	51TP81J+##19YY	52TP81J+##19YY	600			
POLYOLEFIN	04, 09, 60, 53, P3, 48, 57, 90	B, E	51P081J+##19YY	52P081J+##19YY	900			
NYLON	04, 09, 60, 48, 57		51NY81JE##19YY	52NY81JE##19YY	1100			
IRONMAN			51NX81JB6519Y	52NX81JB6519YY	2000			
ROKHARD™	04, 09, 48, 60, 57		51HI81JB##19YY	52HI81JB##19YY	1100			
BRIMSTONE®	04, 09, 60, 90		51GN81JQ##19YY	52GN81JQ##19YY	1200			
EPOXY	04, 09, 90		51OV81JQ##19YY	52OV81JQ##19YY	1200			
MAXROK™	04, 09, 48, 60, 57		51MA81JB##19YY	52MA81JB##19YY	1400			
PHENOLIC	04, 09, 60, 57		51PH81JB##19YY	52PH81JB##19YY	1400			
HIGH-TEMP PHENOLIC	04, 09, 60, 90		51HT81JQ##19YY	52HT81JQ##19YY	1100			
POLY MAXROK™	04, 09, 48, 60, 57	G, K	51MU81J+##19YY	52MU81J+##19YY	1400			
POLYON AL™	04, 09, 48, 60, 57	N, R	51PA81J+##19YY	52PA81J+##19YY	1500			
DW-BLACK			51DW81JLT319YY	52DW81JLT319YY	750			
DW-RED			51DW81JRT319YY	52DW81JRT319YY	1100			
DW-BLUE			51DW81JBT319YY	52DW81JBT319YY	1600			
DW-GRAY			51DW81JGT319YY	52DW81JGT319YY	1700			
POLY-PRO™	04, 09, 48, 60, 63, 57	C, D, I, K, M, U, W	51PP81J+##19YY	52PP81J+##19YY	810			
			51PP81JP4919YY	52PP81JP4919YY	900			
POLYMADIC™	04, 09, 48, 60, 63, 57	I, M	51PP81JH6319YY	52PP81JH6319YY	1000			
			51PM81J+##19YY	52PM81J+##19YY	1000			
POLYON™	04, 09, 60	G, V	51PU81JV6319YY	52PU81JV6319YY	1400			
			51PU81J+##19YY	52PU81J+##19YY				
ENERGY SAVER POLYON™	04, 09, 60		51SW81JU##19YY	52SW81JU##19YY	1500			
POLYFLEXON™ CAST			51RP81JK6319YY	52RP81JK6319YY	1000			
POLYFLEXON™		N, O	51UA81J+6419YY	52UA81J+6419YY	1000			
D-POLYON			51UD81JL6419YY	52UD81JL6419YY	1200			
ULTRAFLEX™			51UX81JO6419YY	52UX81JO6419YY	1200			
CHAMPION			51CP81JN6419YY	52CP81JN6419YY	1200			
DURALASTOMER™	09, 60, 63, 57		51SU81JL##19YY	52SU81JL##19YY	1000			
SUPER ELASTOMER			51EE81JI6019YY	52EE81JI6019YY	1250			
ERGOLASTOMER™	04, 09, 73, 64, 57		51HU81JI##19YY	52HU81JI##19YY	2000			
SEMI-STEEL	04, 09		51SS81JS##19YY	52SS81JS##19YY	1400			
HEAVY DUTY IRON	04, 09, 63		51HS81JS##19YY	52HS81JS##19YY	1600			
DUCTILE	04, 09, 63, 73, B1, B5		51DS81JR##19YY	52DS81JR##19YY	2000			

\*Change wheel denotation for optional overall height or swivel lead.



# DURABLE SUPERIOR CASTERS®

51/52 – MEDIUM HEAVY DUTY FORGED SERIES – 2000 LB

Wheel Diameter	Thread Width	Wheel Type	Available Bearing Options	+ Color	Replace + with a desired wheel color. Replace ## with desired wheel bearing.		Load Cap.
					51 Series Swivel Caster Part #	52 Series Rigid Caster Part #	
8	2	ENERGY SAVER DUCTILE™	04, 09, B1, B5		51CD81JR##19YY	52CD81JR##19YY	2000
		FORGED STEEL	04, 09, 73, 63, B5, B1		51FS81JS##19YY	52FS81JS##19YY	2000
		IRON V-GROOVE	04, 09		51VG81JT##19YY	52VG81JT##19YY	1200
8	2-1/2	MOLD-ON RUBBER			51RS80KB0619YY	52RS80KB0619YY	800
		NEO-ENERGIZER™			51EN80KB2D19YY	52EN80KB2D19YY	850
		PHENOLIC			51PH80KB0619YY	52PH80KB0619YY	1800
		POLYON™			51PU80KV0619YY	52PU80KV0619YY	1600
		SEMI-STEEL			51ZZ80KS0619YY	52SS80KS0619YY	1600
10	2-1/2	MOLD-ON RUBBER			51RS10KB0619YY	52RS10KB0619YY	1000
		PHENOLIC			51PH10KB0619YY	52PH10KB0619YY	2000
		POLYON™			51PU10KV0619YY	52PU10KV0619YY	1600
		SEMI-STEEL			51SS10KS0619YY	52SS10KS0619YY	1700

\*Change wheel denotation for optional overall height or swivel lead.

Our highly trained and experienced customer service and sales staff can help assist you in choosing the appropriate caster or wheel for your application.



# 53/54 – HEAVY DUTY FORGED SERIES – 2,400LB



- Drop forged (ASTM1045) 3/8" thick swivel head
- Integrally forged kingpin 3/4" diameter
- Lower raceway thrust bearing is a tapered roller bearing, providing exceptionally smooth and easy swiveling action and counteracts radial thrust.
- 7/16" diameter hardened ball bearings as main load bearings, with precision tapered thrust bearings
- 3/8" thick steel legs
- Zinc-plated finish
- 3/4" axle bolt with grease fitting

FASTENING PATTERN			
Plate Code	Overall Size	Bolt Holes Pattern	Mounting Bolt Size
19	4-1/2 X 6-1/4	2-7/16 X 4-15/16 SLOTTED TO 3-3/8 X 5-1/4	1/2

WHEEL DIAMETER, OVERALL HEIGHTS AND SWIVEL RADIUS		
Wheel Diameter	Overall Height	Swivel Radius
5	6-1/2	4-3/4
6	7-1/2	5-1/2
8	10-1/8	6-1/4
		7-1/2 (EXTENDED LEAD - CHANGE PART # DIAMETER DESIGNATOR FROM 80 TO 89)
10	11-1/2	7-1/2
12	13-1/2	9-1/8

BRAKE OPTIONS	
Face Contact Brake (F)	T Handle Brake (R)

OTHER OPTIONS	
4-Position Lock (P)	Toe Guard

## 53/54 – HEAVY DUTY FORGED SERIES – 2, 400 LB

Wheel Diameter	Tread Width	Wheel Type	Load Capacity	Add options by replacing YY in part # with option designators.			Color	
				53 Series Swivel Part # To order rigid casters, change part # prefix 81-82.				
				Roller Bearings 23, 24	Tapered Bearing 70	Sealed Precision BB 65		
5	2-1/2	POLYON™	1400	53PU50KG2319YY				
		DUCTILE STEEL	2000	53DS50KR2319YY				
	3	YOKE ONLY		53ZZ50KZ8819YY				
		POLYON™	1400	53PU50LG2419YY				
6	2-1/2 3	YOKE ONLY		53ZZ60KZ8819YY				
		RUBBER MOLD-ON IRON	600	53RS60KB2319YY				
		PHENOLIC	1600	53PH60KB2319YY				
		POLYON™	1600	53PU60K+2319YY			G, V	
		ENERGY SAVER POLYON™	1700	53SW60KU2319YY	53SW60KU7019YY			
		ERGOLASTOMER™	2200			53HU60KI6519YY		
		IRONMAN™	2400			53NX60KB6519YY		
		SEMI-STEEL	1800	53SS60KS2319YY				
		DUCTILE STEEL	2400	53DS60KR2319YY	53DS60KR7019YY			
		ENERGY SAVER DUCTILE™	2400	53CD60KR2319YY	53CD60KR7019YY			
		IRON C42V-GROOVE	2400	53VG60KT2319YY				
		DUCTILE V-GROOVE	2400	53DV60KT2319YY	53DV60KT7019YY			
		YOKE ONLY		53ZZ60LZ8819YY				
		MOLD-ON RUBBER	750	53RS60LB2419YY				
		SUPREME RUBBER™	850		53RH60LS7019YY			
		PHENOLIC	2000	53PH60LB2419YY				
		POLYON™	2000	53PU60L+2419YY			53PU60LG6519YY	G, V
		ENERGY SAVER POLYON™	2200	53SW60LU2419YY	53SW60LU7019YY			
		ULTRAPOLY™	2400	53EX60LG2419YY	53EX60LG7019YY	53EX60LG6519YY		
		TITAN™ POLYMER	2400		53PX60L07319YY	53PX60L06519YY		
		IRONMAN™	2400			53NX60LB6519YY		
		SEMI-STEEL	2400	53SS60LS2419YY				
		DUCTILE STEEL	2400	53DS60LR2419YY	53DS60LR7019YY	53DS60LG6519YY		
		ENERGY SAVER DUCTILE™	2400	53CD60LR2419YY	53CD60LR7019YY			
		IRON V-GROOVE	2400	53VG60L+2419YY			T, W	
		DUCTILE V-GROOVE	2400	53DV60L+2419YY	53DV60LT7019YY	53DV60LT6519YY	T, W	
		FORGED V-GROOVE	2400	53FV60LW2419YY	53FV60LW7019YY			
		FORGED STEEL	2400	53FS60LS2719YY	53FS60LS7919YY			
	2 X 1.5	DW		2400			53DW60LBT419YY	
				2400			53DW60LGT419YY	



# DURABLE SUPERIOR CASTERS®

53/54 – HEAVY DUTY FORGED SERIES – 2, 400 LB

Wheel Diameter	Tread Width	Wheel Type	Load Capacity	Add options by replacing YY in part # with option designators.			Color
				53 Series Swivel Part # To order rigid casters, change part # prefix 81-82.			
				Roller Bearings 23, 24	Tapered Bearing 70	Sealed Precision BB 65	
8	2-1/2	YOKE ONLY		53ZZ80KZ8819YY			
		NEOPRENE ENERGIZER	1400	53EN80KB2319YY		53EN80KB8919YY	
		MOLD-ON RUBBER	850	53RS80KB2319YY			
		SUPREME RUBBER™	950			53RH80KS6519YY	
		CHAMPION™	1700			53CP80KN6719YY	
		PHENOLIC	2000	53PH80KB2319YY			
		POLYON™	2000	53PU80K+2319YY			G, V
		ENERGY SAVER POLYON™	2200	53SW80KU2319YY	53SW80KU7019YY		
		ERGOLASTOMER™	2300			53HU80KI6519YY	
		SEMI-STEEL	1800	53SS80KS2319YY			
		DUCTILE	2400	53DS80KR2319YY	53DS80KR7019YY		
		ENERGY SAVER DUCTILE™	2400	53CD80KR2319YY	53CD80KR7019YY		
	V-GROOVE	2400	53VG80KT2319YY				
	DUCTILE V-GROOVE	2400	53DV80KT2319YY	53DV80KT7019YY			
	3	YOKE ONLY		53ZZ80LZ8819YY			
		MOLD-ON RUBBER	900	53RS80LB2419YY			
		SUPREME RUBBER™	1000		53RH80LS7019YY	53RH80LS6519YY	
		PHENOLIC	2400	53PH80LB2419YY			
		POLYON™	2400	53PU80L+2419YY		53PU80LG6519YY	G, V
		ENERGY SAVER POLYON™	2400	53SW80LU2419YY	53SW80LU7019YY	53SW80LU6519YY	
		ULTRAPOLY™	2400	53EX80LG2419YY	53EX80LG7019YY	53EX80LG6519YY	
		ERGOLASTOMER™	2400			53HU80LI6519YY	
		TITAN™ POLYMER	2400		53PX80LO7919YY	53PX80LO6519YY	
		IRONMAN™	2400			53NX80LB6519YY	
		HIGH-TEMP PHENOLIC	1500	53HT80LQ2419YY			
		EPOXY	1900	53OV80LQ2419YY			
		SEMI-STEEL	2400	53SS80LS2419YY			
		DUCTILE	2400	53DS80LR2419YY	53DS80LR7019YY	53DS80LR6519YY	
		ENERGY SAVER DUCTILE™	2400	53CD80LR2419YY	53CD80LR7019YY		
		V-GROOVE	2400	53VG80L+2419YY			T, W
		DUCTILE V-GROOVE	2400	53DV80L+2419YY	53DV80L+7019YY	53DV80LT6519YY	T, W
		FORGED V-GROOVE	2400	53FV80LW2419YY	53FV80LW7019YY		
	FORGED STEEL	2400	53FS80LS2719YY	53FS80LS7019YY			
2 X 1.5	DW	2400			53DW80LBT419YY		
		2400			53DW80LGT419YY		
10	2-1/2	YOKE ONLY		53ZZ10KZ8819YY			
		MOLD-ON RUBBER	1000	53RS10KB2319YY			
		PHENOLIC	2400	53PH10KB2319YY			
		POLYON™	2200	53PU10K+2319YY			
		ENERGY SAVER POLYON™	2400	53SW10KU2319YY	53SW10KU7019YY		
		SEMI-STEEL	2000	53SS10KS2319YY			
	3	DUCTILE	2400	53DS10KR2319YY	53DS10KR7019YY		
		YOKE ONLY		53ZZ10LZ8819YY			
		MOLD-ON RUBBER	1100	53RS10LB2419YY	53RS10LB7019YY		
		SUPREME RUBBER™	1300		53RH10LS7019YY	53RH10LS6519YY	
		PHENOLIC	2400	53PH10LB2419YY			
		POLYON™	2400	53PU10L+2419YY		53PU10LG6519YY	G, V
		ENERGY SAVER POLYON™	2400	53SW10LU2419YY	53SW10LU7019YY		
		ULTRAPOLY™	2400	53EX10LG2419YY	53EX10LG7019YY	53EX10LG6519YY	
		ERGOLASTOMER™	2400			53HU10LI6519YY	
		TITAN™ POLYMER	2400		53PX10LO7919YY	53PX10LO6519YY	
		IRONMAN™	2400			53NX10LB6519YY	
		HIGH-TEMP PHENOLIC	2400	53HT10LQ2419YY			
		EPOXY	2400	53OV10LQ2419YY			
		SEMI-STEEL	2400	53SS10LS2419YY			
		DUCTILE	2400	53DS10LR2419YY	53DS10LR7019YY	53DS10LR6519YY	
		ENERGY SAVER DUCTILE™	2400	53CD10LR2419YY	53CD10LR7019YY		
		V-GROOVE	2400	53VG10L+2419YY			T, W
		DUCTILE V-GROOVE	2400	53DV10L+2419YY	53DV10L+7019YY	53DV10LT6519YY	T, W
	FORGED STEEL	2400	53FS10LS2719YY	53FS19LS7919YY			
	2 X 1.5	DW	2400			53DW10LBT419YY	
			2400			53DW10LGT419YY	
12	2.5	MOLD-ON RUBBER	1200	53RS12QB2419YY			
		PHENOLIC	2400	53PH12QB2419YY			
		POLYON™	2400	53PU12Q+2419YY			G, V
		ENERGY SAVER POLYON™	2400	53SW12QU2419YY			
	3	SEMI-STEEL	2000	53SS12QS2419YY			
		YOKE ONLY		53ZZ12LZ8819YY			
		MOLD-ON RUBBER	1300	53RS12LB2419YY			
		SUPREME RUBBER™	1400		53RH12LS7019YY		

53/54 – HEAVY DUTY FORGED SERIES – 2, 400 LB

Wheel Diameter	Tread Width	Wheel Type	Load Capacity	Add options by replacing YY in part # with option designators.			Color
				53 Series Swivel Part # To order rigid casters, change part # prefix 81-82.			
				Roller Bearings 23, 24	Tapered Bearing 70	Sealed Precision BB 65	
12	3	PHENOLIC	2400	53PH12LB2419YY			
		EPOXY	2400	53OV12LQ2419YY			
		HIGH-TEMP PHENOLIC	2400	53HT12LQ2419YY			
		POLYON™	2400	53PU12L+2419YY		53PU12LG6519YY	G, V
		ENERGY SAVER POLYON™	2400	53SW12LU2419YY	53SW12LU7019YY		
		ULTRAPOLY™	2400	53EX12LG2419YY	53EX12LG7019YY	53EX12LG6519YY	
		TITAN™ POLYMER	2400		53PX12LO7919YY	53PX12LO6519YY	
		IRONMAN™	2400			53NX12LB6519YY	
		SEMI-STEEL	2400	53SS12LS2419YY			
		DUCTILE	2400	53DS12LR2419YY	53DS12LR7019YY	53DS12LR6519YY	
		ENERGY SAVER DUCTILE™	2400	53CD12LR2419YY	53CD12LR7019YY		
FORGED STEEL	2400	53FS12LS2719YY	53FS12LS7919YY				

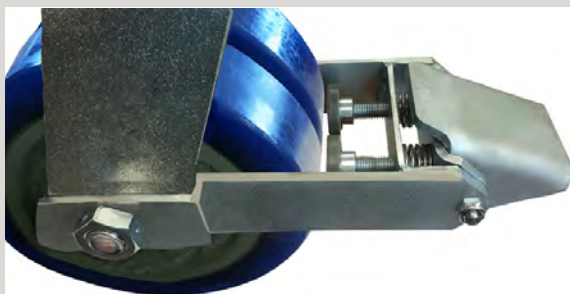

**FIELD INSTALLABLE  
BRAKES ARE NOW  
AVAILABLE!**

*Please turn to page number 173 to view all available brake options.*

## 57/58 – HEAVY DUTY FORGED SERIES – 6,000 LB



57

58

- Constructed 5/16" thick top plate from hot forged ASTM1045 steel
- Integrated with a 3" diameter, precisely machined single raceway of 1/2" ball bearings
- Grease fitting on raceway and axle
- 3/8" thick steel formed legs
- 3/4" axle
- Zinc-plated finish

WHEEL DIAMETER, OVERALL HEIGHTS AND SWIVEL RADIUS			
Wheel Diameter	Overall Height	Swivel Radius	Denotation
5	7	4	50
6	7-1/2	5-1/2	60
8	10-1/8	6-1/4	80
		7-1/2	89
10	11-1/2	7-1/2	10
12	13-1/2	9-1/8	12

BRAKE OPTIONS		OTHER OPTIONS		
Face Contact Brake (F)	T Handle Brake (R)	4-Position Lock (P)	Toe Guard	4-Position Lock Bolt-on. Order Separately Part # 4PSL57

FASTENING PATTERN			
Plate Code	Overall Size	Bolt Holes Pattern	Mounting Bolt Size
19	4-1/2 X 6-1/4	2-7/16 X 4-15/16 SLOTTED TO 3-3/8 X 5-1/4	1/2

### 57/58 – HEAVY DUTY FORGED SERIES – 6,000 LB

Wheel Diameter	Tread Width	Wheel Type	Load Capacity	Add options by replacing YY in part # with option designators.			Color	Overall Height	Swivel Radius
				57 Series Swivel Caster Part # To order rigid casters change part # prefix 57 to 58.					
				Roller Bearings 24, 27	Tapered Bearing 70	Sealed Precision BB 65			
5	2-1/2	POLYON™	1400	57PU50QG2419YY			G, V	7	4
		DUCTILE STEEL	2000	57DS50QR2419YY					
	3	YOKE ONLY		57ZZ50QZ8819YY					
		POLYON™	1400	57PU50LG2419YY					
6	2-1/2	YOKE ONLY		57ZZ60QZ8819YY			G, V	7-1/2	4-1/2
		RUBBER MOLD-ON IRON	600	57RS60QB2419YY					
		PHENOLIC	1600	57PH60QB2419YY					
		POLYON™	1600	57PU60Q+2419YY					
		ENERGY SAVER POLYON™	1700	57SW60QU2419YY	57SW60QU7019YY				
		ERGOLASTOMER™	2200			57HU60QI6519YY			
		IRONMAN™	6000			57NX60QB6519YY			
		SEMI-STEEL	1800	57SS60QS2419YY					
		DUCTILE STEEL	3500	57DS60QR2419YY	57DS60QR7019YY				
		ENERGY SAVER DUCTILE™	3500	57CD60QR2419YY	57CD60QR7019YY				
		IRON V-GROOVE	2500	57VG60QT2419YY					
		DUCTILE V-GROOVE	3500	57DV60QT2419YY	57DV60QT7019YY				
	3	YOKE ONLY		57ZZ60LZ8819YY					
		MOLD-ON RUBBER	750	57RS60LB2419YY					
		SUPREME RUBBER™	850		57RH60LS7019YY				
		PHENOLIC	2000	57PH60LB2419YY					
		POLYON™	2000	57PU60L+2419YY		57PU60LG6519YY	G, V		
		ENERGY SAVER POLYON™	2200	57SW60LU2419YY	57SW60LU7019YY				
		ULTRAPOLY™	3000	57EX60LG2419YY	57EX60LG7019YY	57EX60LG6519YY			
		TITAN™ POLYMER	4000		57PX60LO7019YY	57PX60LO6519YY			
		IRONMAN™	6000			57NX60LB6519YY			
		SEMI-STEEL	2500	57SS60LS2419YY					
		DUCTILE STEEL	6000	57DS60LR2419YY	57DS60LR7019YY	57DS60LG6519YY			
		ENERGY SAVER DUCTILE™	6000	57CD60LR2419YY	57CD60LR7019YY				
IRON V-GROOVE	3500	57VG60L+2419YY			T, W				
DUCTILE V-GROOVE	5000	57DV60L+2419YY	57DV60LT7019YY	57DV60LT6519YY	T, W				
FORGED V-GROOVE	6000	57FV60LW2419YY	57FV60LW7019YY						
FORGED STEEL	6000	57FS60LS2719YY	57FS60LS7919YY						
2 X 1.5	DW		3900			57DW60LBT419YY			
			3500			57DW60LGT419YY			



57/58 – HEAVY DUTY FORGED SERIES – 6,000 LB

Wheel Diameter	Tread Width	Wheel Type	Load Capacity	Add options by replacing YY in part # with option designators.			Color	Overall Height	Swivel Radius
				57 Series Swivel Caster Part # To order rigid casters change part # prefix 57 to 58.					
				Roller Bearings 24, 27	Tapered Bearing 70	Sealed Precision BB 65			
8	2-1/2 3	YOKE ONLY		57ZZ80QZ8819YY				10-1/8	6-1/4
		NEOPRENE ENERGIZER	1400	57EN80KB2319YY					
		MOLD-ON RUBBER	850	57RS80QB2419YY					
		SUPREME RUBBER™	950				57RH80QS6519YY		
		CHAMPION™	1700				57CP80QN6719YY		
		PHENOLIC	2000	57PH80QB2419YY					
		POLYON™	2000	57PU80Q+2419YY				G, V	
		ENERGY SAVER POLYON™	2200	57SW80QU2419YY	57SW80QU7019YY				
		ERGOLASTOMER™	2300				57HU80QI6519YY		
		SEMI-STEEL	1800	57SS80QS2419YY					
		DUCTILE	6000	57DS80QR2419YY	57DS80QR7019YY				
		ENERGY SAVER DUCTILE™	6000	57CD80QR2419YY	57CD80QR7019YY				
		IRON V-GROOVE	2500	57VG80QT2419YY					
		DUCTILE V-GROOVE	3500	57DV80QT2419YY	57DV80QT7019YY				
		YOKE ONLY		57ZZ80LZ8819YY					
		MOLD-ON RUBBER	900	57RS80LB2419YY		57RH80LS7019YY	57RH80LS6519YY		
		SUPREME RUBBER™	1000						
		PHENOLIC	2500	57PH80LB2419YY					
		POLYON™	2500	57PU80L+2419YY			57PU80LG6519YY	G, V	
		ENERGY SAVER POLYON™	2700	57SW80LU2419YY	57SW80LU7019YY	57SW80LU6519YY			
		ULTRAPOLY™	3500	57EX80LG2419YY	57EX80LG7019YY	57EX80LG6519YY			
		ERGOLASTOMER™	3000				57HU80LI6519YY		
		TITAN™ POLYMER	5500		57PX80LO7019YY	57PX80LO6519YY			
		IRONMAN™	6000				57NX80LB6519YY		
		HIGH-TEMP PHENOLIC	1500	57HT80LQ2419YY					
		EPOXY	1900	57OV80LQ2419YY					
		SEMI-STEEL	2500	57SS80LS2419YY					
	DUCTILE	6000	57DS80LR2419YY	57DS80LR7019YY	57DS80LR6519YY				
	ENERGY SAVER DUCTILE™	6000	57CD80LR2419YY	57CD80LR7019YY					
	IRON V-GROOVE	3500	57VG80L+2419YY				T, W		
	DUCTILE V-GROOVE	5000	57DV80L+2419YY	57DV80L+7019YY	57DV80L+6519YY		T, W		
	FORGED V-GROOVE	6000	57FV80LW2419YY	57FV80LW7919YY					
	FORGED STEEL	6000	57FS80LS2719YY	57FS80LS7019YY					
	2 X 1.5	DW	4500			57DW80LBT419YY			
			4000			57DW80LGT419YY			
8	3	YOKE ONLY		57ZZ89LZ8819YY				10-1/8	7-1/2
		MOLD-ON RUBBER	900	57RS89LB2419YY					
		SUPREME RUBBER™	1000		57RH89LS7019YY	57RH89LS6519YY			
		PHENOLIC	2500	57PH89LB2419YY					
		POLYON™	2500	57PU89L+2419YY			57PU89LG6519YY	G, V	
		ENERGY SAVER POLYON™	2700	57SW89LU2419YY	57SW89LU7019YY	57SW89LU6519YY			
		ULTRAPOLY™	3500	57EX89LG2419YY	57EX89LG7019YY	57EX89LG6519YY			
		ERGOLASTOMER™	3000				57HU89LI6519YY		
		TITAN™ POLYMER	6000		57PX89LO7019YY	57PX89LO6519YY			
		IRONMAN™	6000				57NX89LB6519YY		
		HIGH-TEMP PHENOLIC	1500	57HT89LQ2419YY					
		EPOXY	1900	57OV89LQ2419YY					
		SEMI-STEEL	2500	57SS89LS2419YY					
		DUCTILE	6000	57DS89LR2419YY	57DS89LR7019YY	57DS89LR6519YY			
		ENERGY SAVER DUCTILE™	6000	57CD89LR2419YY	57CD89LR7019YY				
		IRON C62V-GROOVE	3500	57VG89L+2419YY				T, W	
		DUCTILE V-GROOVE	5000	57DV89L+2419YY	57DV89L+7019YY	57DV89L+6519YY		T, W	
	FORGED V-GROOVE	6000	57FV89LW2419YY	57FV89LW7019YY					
	FORGED STEEL	6000	57FS89LS2719YY	57FS89LS7019YY					
		2 X 1.5	DW	4500			57DW89LBT419YY		
				4000			57DW89LGT419YY		
10	2.5	MOLD-ON RUBBER	1000	57RS10QB2419YY				11-1/2	7-1/2
		PHENOLIC	2500	57PH10QB2419YY					
		POLYON™	2200	57PU10Q+2419YY					



# DURABLE SUPERIOR CASTERS®

57/58 – HEAVY DUTY FORGED SERIES – 6,000 LB

Wheel Diameter	Tread Width	Wheel Type	Load Capacity	Add options by replacing YY in part # with option designators.			Color	Overall Height	Swivel Radius	
				57 Series Swivel Caster Part # To order rigid casters change part # prefix 57 to 58.						
				Roller Bearings 24, 27	Tapered Bearing 70	Sealed Precision BB 65				
3		ENERGY SAVER POLYON™	2500	57SW10QU2419YY	57SW10QU7019YY					
		SEMI-STEEL	2000	57SS10QS2419YY						
		DUCTILE	6000	57DS10QR2419YY	57DS10QR7019YY					
	3		YOKE ONLY		57ZZ10LZ8819YY					
			MOLD-ON RUBBER	1100	57RS10LB2419YY	57RS10LB7019YY				
			SUPREME RUBBER™	1300		57RH10LS7019YY	57RH10LS6519YY			
			PHENOLIC	2900	57PH10LB2419YY					
			POLYON™	3000	57PU10L+2419YY		57PU10LG6519YY	G, V		
			ENERGY SAVER POLYON™	3000	57SW10LU2419YY	57SW10LU7019YY				
			ULTRAPOLY™	4000	57EX10LG2419YY	57EX10LG7019YY	57EX10LG6519YY			
			ERGOLASTOMER™	3200			57HU10LI6519YY			
			TITAN™ POLYMER	6000		57PX10LO7019YY	57PH10LO6519YY			
			IRONMAN™	6000			57NX10LB6519YY			
			HIGH-TEMP PHENOLIC	2400	57HT10LQ2419YY					
			EPOXY	2400	57OV10LQ2419YY					
			SEMI-STEEL	2500	57SS10LS2419YY					
			DUCTILE	6000	57DS10LR2419YY	57DS10LR7019YY	57DS10LR6519YY			
			ENERGY SAVER DUCTILE™	6000	57CD10LR2419YY	57CD10LR7019YY				
			V-GROOVE	3500	57VG10L+2419YY			T, W		
			DUCTILE V-GROOVE	6000	57DV10L+2419YY	57DV10L+7019YY	57DV10L+6519YY	T, W		
			FORGED STEEL	6000	57FS10LS2719YY	57FS10LS7919YY				
	2 X 1.5	DW		5200			57DW10LBT419YY			
				4600			57DW10LGT419YY			
	12	2.5	MOLD-ON RUBBER	1200	57RS12QB2419YY				13-1/2	9-1/8
			PHENOLIC	3000	57PH12QB2419YY					
			POLYON™	2500	57PU12Q+2419YY			G, V		
			ENERGY SAVER POLYON™	2700	57SW12QU2419YY					
			SEMI-STEEL	2000	57SS12QS2419YY					
3			YOKE ONLY		57ZZ12LZ8819YY					
			MOLD-ON RUBBER	1300	57RS12LB2419YY					
			SUPREME RUBBER™	1400		57RH12LS7019YY				
			PHENOLIC	3500	57PH12LB2419YY					
			EPOXY	2600	57OV12LQ2419YY					
			HIGH-TEMP PHENOLIC	2600	57HT12LQ2419YY					
			POLYON™	3500	57PU12L+2419YY			57PU12LG6519YY	G, V	
			ENERGY SAVER POLYON™	3500	57SW12LU2419YY	57SW12LU7019YY				
			ULTRAPOLY™	5000	57EX12LG2419YY	57EX12LG7019YY	57EX12LG6519YY			
			TITAN™ POLYMER	6000		57PX12LO7019YY	57PH12LO6519YY			
			IRONMAN™	6000			57NX12LB6519YY			
			SEMI-STEEL	2500	57SS12LS2419YY					
			DUCTILE	6000	57DS12LR2419YY	57DS12LR7019YY	57DS12LR6519YY			
			ENERGY SAVER DUCTILE™	6000	57CD12LR2419YY	57CD12LR7019YY				
			FORGED STEEL	6000	57FS12LS2719YY	57FS12LS7919YY				



# 55/56 – HEAVY DUTY FORGED SERIES – 3,500 LB



- Drop forged (ASTM1045) 3/8" thick swivel head
- Integrally forged kingpin 1" diameter
- Lower raceway thrust bearing is a tapered roller bearing, providing exceptionally smooth and easy swiveling action and counteracts radial thrust.
- 1/2" diameter hardened ball bearings as main load bearings, with precision tapered thrust bearings
- 3/8" thick steel legs
- Zinc-plated finish
- 3/4" axle bolt with grease fitting

BRAKE OPTIONS	
Face Contact Brake (F)	T Handle Brake (R)

OTHER OPTIONS		
4-Position Lock (P)	4-Position Lock Bolt-on. Order Separately Part # 4PSL55	Toe Guard

FASTENING PATTERN			
Plate Code	Overall Size	Bolt Holes Pattern	Mounting Bolt Size
25	5-1/4 X 7-1/4	3-3/8 X 5-1/4 SLOTTED TO 4-1/8 X 6-1/8	1/2

55/56 – HEAVY DUTY FORGED SERIES – 3,500 LB

Wheel Diameter	Tread Width	Wheel Type	Load Capacity	Add options by replacing YY in part # with option designators.			Color	Overall Height	Swivel Radius
				55 Series Swivel Caster Part # To order rigid casters, change part # prefix 55 to 56.					
				Roller Bearings 24, 27	Tapered Bearing 70	Sealed Precision BB 65			
5	2-1/2	POLYON™	1400	55PU50QG2425YY			7-1/2	3-7/8	
		DUCTILE STEEL	2000	55DS50QR2425YY					
	3	YOKE ONLY		55ZZ50LZ8825YY					
6	2-1/2	POLYON™	1400	55PU50LG2425YY			G, V		
		RUBBER MOLD-ON IRON	600	55RS60QB2425YY					
		PHENOLIC	1600	55PH60QB2425YY					
		POLYON™	1600	55PU60Q+2425YY					
		ENERGY SAVER POLYON™	1700	55SW60QU2425YY	55SW60QU7025YY				
		ERGOLASTOMER™	2200			55HU60QI6525YY			
		IRONMAN™	3500			55NX60QB6525YY			
		SEMI-STEEL	1800	55SS60QS2425YY					
		DUCTILE STEEL	3500	55DS60QR2425YY	55DS60QR7025YY				
		ENERGY SAVER DUCTILE™	3500	55CD60QR2425YY	55CD60QR7025YY				
	IRON C41V-GROOVE	2500	55VG60QT2425YY						
	DUCTILE V-GROOVE	3500	55DV60QT2425YY	55DV60QT7025YY					
	3	YOKE ONLY		55ZZ60LZ8825YY			G, V	8	5-1/2
		MOLD-ON RUBBER	750	55RS60LB2425YY					
		SUPREME RUBBER™	850		55RH60LS7025YY				
		PHENOLIC	2000	55PH60LB2425YY					
		POLYON™	2000	55PU60L+2425YY		55PU60LG6525YY			
		ENERGY SAVER POLYON™	2200	55SW60LU2425YY	55SW60LU7025YY				
		ULTRAPOLY™	3000	55EX60LG2425YY	55EX60LG7025YY	55EX60LG6525YY			
		TITAN™ POLYMER	3500		55PX60LO7925YY	55PX60LO6525YY			
		IRONMAN™	3500			55NX60LB6525YY			
SEMI-STEEL		2500	55SS60LS2425YY						
DUCTILE STEEL		3500	55DS60LR2425YY	55DS60LR7025YY	55DS60LG6525YY				
ENERGY SAVER DUCTILE™	3500	55CD60LR2425YY	55CD60LR7025YY						
IRON C56V-GROOVE	3500	55VG60L+2425YY			T, W				
DUCTILE V-GROOVE	3500	55DV60L+2425YY	55DV60LT7025YY	55DV60LT6525YY	T, W				
FORGED V-GROOVE	3500	55FV60LW2425YY	55FV60LW7025YY						
FORGED STEEL	3500	55FS60LS2725YY	55FS60LS7925YY						



# DURABLE SUPERIOR CASTERS®

55/56 – HEAVY DUTY FORGED SERIES – 3,500 LB

Wheel Diameter	Tread Width	Wheel Type	Load Capacity	Add options by replacing YY in part # with option designators.			Color	Overall Height	Swivel Radius	
				55 Series Swivel Caster Part # To order rigid casters, change part # prefix 55 to 56.						
				Roller Bearings 24, 27	Tapered Bearing 70	Sealed Precision BB 65				
6	2 X 1.5	DW	3500			55DW60LBT425YY	8	5-1/2		
			3500			55DW60LGT425YY				
8	3	NEOPRENE ENERGIZER	1400	55EN80KB2325YY		55EN80KB8925YY	G, V	10-1/2	6-1/4	
		MOLD-ON RUBBER	850	55RS80QB2425YY						
		SUPREME RUBBER™	950			55RH80QS6525YY				
		CHAMPION™	1700			55CP80QN6725YY				
		PHENOLIC	2000	55PH80QB2425YY						
		POLYON™	2000	55PU80Q+2425YY						
		ENERGY SAVER POLYON™	2200	55SW80QU2425YY	55SW80QU7025YY					
		ERGOLASTOMER™	2300			55HU80QI6525YY				
		SEMI-STEEL	1800	55SS80QS2425YY						
		DUCTILE	3500	55DS80QR2425YY	55DS80QR7025YY					
		ENERGY SAVER DUCTILE™	3500	55CD80QR2425YY	55CD80QR7025YY					
		IRON V-GROOVE	2500	55VG80QT2425YY						
	DUCTILE V-GROOVE	3500	55DV80QT2425YY	55DV80QT7025YY						
	YOKE ONLY			55ZZ80LZ8825YY						
	MOLD-ON RUBBER	900	55RS80LB2425YY							
	SUPREME RUBBER™	1000		55RH80LS7025YY	55RH80LS6525YY					
	PHENOLIC	2500	55PH80LB2425YY							
	POLYON™	2500	55PU80L+2425YY		55PU80LG6525YY					
	ENERGY SAVER POLYON™	2400	55SW80LU2425YY	55SW80LU7025YY	55SW80LU6525YY					
	ULTRAPOLY™	3500	55EX80LG2425YY	55EX80LG7025YY	55EX80LG6525YY					
	ERGOLASTOMER™	3000			55HU80LI6525YY					
	TITAN™ POLYMER	3500		55PX80LO7925YY	55PX80LO6525YY					
	IRONMAN™	3500			55NX80LB6525YY					
	HIGH-TEMP PHENOLIC	1500	55HT80LQ2425YY							
	EPOXY	1900	55OV80LQ2425YY							
	SEMI-STEEL	2500	55SS80LS2425YY							
	DUCTILE	3500	55DS80LR2425YY	55DS80LR7025YY	55DS80LR6525YY					
	ENERGY SAVER DUCTILE™	3500	55CD80LR2425YY	55CD80LR7025YY						
	IRON C94V-GROOVE	3500	55VG80L+2425YY							
	DUCTILE V-GROOVE	3500	55DV80L+2425YY	55DV80L+7025YY	55DV80LT6525YY					
	FORGED V-GROOVE	3500	55FV80LW2425YY	55FV80LW7925YY						
	FORGED STEEL	3500	55FS80LS2725YY	55FS80LS7025YY						
	2 X 1.5	DW	3500			55DW80LBT425YY				
3500					55DW80LGT425YY					
10	3	MOLD-ON RUBBER	1000	55RS10QB2425YY			G, V	12-1/2	8	
		PHENOLIC	2500	55PH10QB2425YY						
		POLYON™	2200	55PU10Q+2425YY						
		ENERGY SAVER POLYON™	2400	55SW10QU2425YY	55SW10QU7025YY					
		SEMI-STEEL	2000	55SS10QS2425YY						
		DUCTILE	3500	55DS10QR2425YY	55DS10QR7025YY					
		YOKE ONLY			55ZZ10LZ8825YY					
		MOLD-ON RUBBER	1100	55RS10LB2425YY	55RS10LB7025YY					
		SUPREME RUBBER™	1300		55RH10LS7025YY	55RH10LS6525YY				
		PHENOLIC	3900	55PH10LB2425YY						
		POLYON™	3000	55PU10L+2425YY		55PU10LG6525YY				
		ENERGY SAVER POLYON™	3500	55SW10LU2425YY	55SW10LU7025YY					
	ULTRAPOLY™	3500	55EX10LG2425YY	55EX10LG7025YY	55EX10LG6525YY					
	ERGOLASTOMER™	3200			55HU10LI6525YY					
	TITAN™ POLYMER	3500		55PX10LO7925YY	55PX10LO6525YY					
	IRONMAN™	3500			55NX10LB6525YY					
	HIGH-TEMP PHENOLIC	2400	55HT10LQ2425YY							
	EPOXY	2400	55OV10LQ2425YY							
	SEMI-STEEL	2500	55SS10LS2425YY							
	DUCTILE	3500	55DS10LR2425YY	55DS10LR7025YY	55DS10LR6525YY					
	ENERGY SAVER DUCTILE™	3500	55CD10LR2425YY	55CD10LR7025YY						
	V-GROOVE	3500	55VG10L+2425YY							
	DUCTILE V-GROOVE	3500	55DV10L+2425YY	55DV10L+7025YY	55DV10LT6525YY					
	FORGED STEEL	3500	55FS10LS2725YY	55FS19LS7925YY						
	2 X 1.5	DW	3500			55DW10LBT425YY				
			3500			55DW10LGT425YY				

55/56 – HEAVY DUTY FORGED SERIES – 3,500 LB

Wheel Diameter	Tread Width	Wheel Type	Load Capacity	Add options by replacing YY in part # with option designators.			Color	Overall Height	Swivel Radius
				55 Series Swivel Caster Part # To order rigid casters, change part # prefix 55 to 56.					
				Roller Bearings 24, 27	Tapered Bearing 70	Sealed Precision BB 65			
12	2-1/2	MOLD-ON RUBBER	1200	55RS12QB2425YY				15-1/2	8-1/2
		PHENOLIC	3000	55PH12QB2425YY					
		POLYON™	2500	55PU12Q+2425YY			G, V		
		ENERGY SAVER POLYON™	3500	55SW12QU2425YY					
		SEMI-STEEL	2000	55SS12QS2425YY					
			YOKE ONLY		55ZZ12LZ8825YY				
			MOLD-ON RUBBER	1300	55RS12LB2425YY				
			SUPREME RUBBER™	1400		55RH12LS7025YY			
			PHENOLIC	3500	55PH12LB2425YY				
			EPOXY	2600	55OV12LQ2425YY				
			HIGH-TEMP PHENOLIC	2600	55HT12LQ2425YY				
			POLYON™	3500	55PU12L+2425YY		55PU12LG6525YY	G, V	
			ENERGY SAVER POLYON™	3500	55SW12LU2425YY	55SW12LU7025YY			
			ULTRAPOLY™	3500	55EX12LG2425YY	55EX12LG7025YY	55EX12LG6525YY		
			TITAN™ POLYMER	3500		55PX12L07925YY	55PX12L06525YY		
			IRONMAN™	3500			55NX12LB6525YY		
			SEMI-STEEL	2500	55SS12LS2425YY				
			DUCTILE	3500	55DS12LR2425YY	55DS12LR7025YY	55DS12LR6525YY		
			ENERGY SAVER DUCTILE™	3500	55CD12LR2425YY	55CD12LR7025YY			
			FORGED STEEL	3500	55FS12LS2725YY	55FS12LS7925YY			

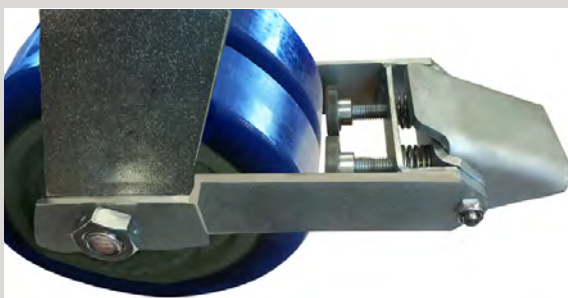

**FIELD INSTALLABLE  
BRAKES ARE NOW  
AVAILABLE!**



*Please turn to page number 173 to view all available brake options.*

## 61/62 – HEAVY DUTY KINGPINLESS SERIES – 7,000 LB



Swivel caster shown with optional face contact brake  
Part #61hu80li6525fy

- ASTM1045 drop forged swivel head, 5/16" thick, 3" diameter precisely machined raceway of 1/2" diameter hardened ball bearings
- Legs are double welded 3/8" thick steel
- 3/4" axle bolt/nut
- Zinc-plated finish
- Grease fitting on raceway and axle

BRAKE OPTIONS		
		
Face Contact Brake (F)	T Handle Brake (R)	Brake Kits

OTHER OPTIONS		
		
4-Position Lock (P)	Toe Guard	4-Position Lock Bolt-on. Order Separately Part # 4PSL61

FASTENING PATTERN			
Plate Code	Overall Size	Bolt Holes Pattern	Mounting Bolt Size
25	5-1/4 X 7-1/4	3-3/8 X 5-1/4 SLOTTED TO 4-1/8 X 6-1/8	1/2

### 61/62 – HEAVY DUTY KINGPINLESS SERIES – 7,000 LB

Wheel Diameter	Tread Width	Wheel Type	Load Capacity	Add options by replacing YY in part # with option designators.			*Load Cap.	+ Color	Overall Height	Swivel Radius
				61 Series Swivel Caster Part # To order rigid casters, change part # prefix 61 to 62.						
				Roller Bearings 24, 27	Sealed Precision BB 65	Tapered Bearing 70, 79				
5	YOKE ONLY			61ZZ50LZ8825YY				7-1/2	5-3/4	
	2-1/2	DUCTILE STEEL	2000	61DS50QR2425YY						
	3	POLYON™	1400	61PU50LG2425YY						
2-1/2	YOKE ONLY			61ZZ60LZ8825YY				8	4-3/4	
	MOLD-ON RUBBER	700	61RS60QB2425YY							
		PHENOLIC	1600	61PH60QB2425YY						G, V
		POLYON™	1600	61PU60Q+2425YY						
	ENERGY SAVER POLYON™	1700	61SW60QU2425YY		61SW60QU7025YY					
	ERGOLASTOMER™	2200		61HU60QI6525YY						
	SEMI-STEEL	1800	61SS60QS2425YY							
	DUCTILE STEEL	3500	61DS60QR2425YY		61DS60QR7025YY					
	ENERGY SAVER DUCTILE™	3500	61CD60QR2425YY		61CD60QR7025YY					
	IRON V-GROOVE	2500	61VG60QT2425YY							
	DUCTILE IRON V-GROOVE	3500	61DV60QT2425YY		61DV60QT7025YY					
	MOLD-ON RUBBER	750	61RS60LB2425YY							
	SUPREME RUBBER™	850			61RH60LS7025YY					
	PHENOLIC	2000	61PH60LB2425YY							
POLYON™	2000	61PU60L+2425YY				G, V				
ENERGY SAVER POLYON™	2200	61SW60LU2425YY		61SW60LU2425YY						
ULTRAPOLY™	3000	61EX60LG2425YY	61EX60LG6525YY	61EX60LG7025YY						
TITAN™ POLYMER	4000		61PX60LO6525YY	61PX60LO7925YY						
IRONMAN	7200		61NX60LB6525YY							
3	SEMI-STEEL	2500	61SS60LS2425YY							
	DUCTILE STEEL	6000	61DS60LR2425YY	61DS60LR6525YY	61DS60LR7025YY	*7000				
	ENERGY SAVER DUCTILE™	6000	61CD60LR2425YY		61CD60LR7025YY	*7000				
	FORGED STEEL	6000	61FS60LS2725YY		61FS60LS7925YY	*7000				
	IRON V-GROOVE	3500	61VG60L+2425YY			T, W				
	DUCTILE IRON V-GROOVE	5000	61DV60L+2425YY	61DV60LT6525YY	61DV60LT7025YY	T, W				
FORGED IRON V-GROOVE	6000	61FV60LW2725YY		61FV60LW7925YY	*7000					

\*Load capacity with tapered bearings



61/62 – HEAVY DUTY KINGPINLESS SERIES – 7,000 LB

Wheel Diameter	Tread Width	Wheel Type	Load Capacity	Add options by replacing YY in part # with option designators.			*Load Cap.	+ Color	Overall Height	Swivel Radius
				61 Series Swivel Caster Part # To order rigid casters, change part # prefix 61 to 62.						
				Roller Bearings 24, 27	Sealed Precision BB 65	Tapered Bearing 70, 79				
8	2X1.5	DW	3900			61DW60LB2425YY				
			3500			61DW60LGT425YY				
	2-1/2	YOKE ONLY			61ZZ80LZ8825YY					
		NEOPRENE ENERGIZER		1400	61EN80KB2325YY					
		MOLD-ON RUBBER	850	61RS80QB2425YY						
		PHENOLIC	2000	61PH80QB2425YY						
		POLYON™	2000	61PU80Q+2425YY				G, V		
		ENERGY SAVER POLYON™	2200	61SW80QU2425YY			61SW80QU7025YY			
		ERGOLASTOMER™	2300		61HU80QI6525YY					
		SEMI-STEEL	1800	61SS80QS2425YY						
		DUCTILE	4000	61DS80QR2425YY			61DS80QR7025YY			
		ENERGY SAVER DUCTILE™	4000	61CD80QR2425YY	61CD80QR6525YY		61CD80QR7025YY			
		IRON V-GROOVE	2500	61VG80QT2425YY						
		DUCTILE IRON V-GROOVE	3500	61DV80QT2425YY			61DV80WT7025YY			
		3	MOLD-ON RUBBER	900	61RS80LB2425YY					
			SUPREME RUBBER™	1000			61RH80LS7025YY			
	PHENOLIC		2500	61PH80LB2425YY						
	HIGH-TEMP PHENOLIC		1500	61HT80LQ2425YY						
	EPOXY		1900	61OV80LQ2425YY						
	POLYON™		2500	61PU80L+2425YY	61PU80LG6525YY			G, V		
	ENERGY SAVER POLYON™		2700	61SW80LU2425YY	61SW80LU6525YY	61SW80LU7025YY				
	ULTRAPOLY™		3500	61EX80LG2425YY	61EX80LG6525YY	61EX80LG7025YY				
	ERGOLASTOMER™		3000		61HU80LI6525YY					
	TITAN™ POLYMER		5500		61PX80LO6525YY	61PX80LO7925YY				
	IRONMAN		7000		61NX80LB6525YY					
	SEMI-STEEL		2500	61SS80LS2425YY						
	DUCTILE		6000	61DS80LR2425YY	61DS80LR6525YY	61DS80LR7025YY	*7000			
	ENERGY SAVER DUCTILE™		6000	61CD80LR2425YY		61CD80LR7025YY	*7000			
	FORGED STEEL		6000	61FS80LS2725YY		61FS80LS7925YY	*7000			
	IRON V-GROOVE		3500	61VG80L+2425YY				T, W		
	DUCTILE IRON V-GROOVE	5000	61DV80L+2425YY	61DV80L+6525YY	61DV80L+7025YY		T, W			
	FORGED IRON V-GROOVE	6000	61FV80LW2425YY		61FV80LW7925YY	*7000				
	2X1.5	DW	4500			61DW80LB2425YY				
			4000			61DW80LGT425YY				
	10	2-1/2	YOKE ONLY		61ZZ10LZ8825YY					
			MOLD-ON RUBBER	1000	61RS10QB2425YY					
			PHENOLIC	2500	61PH10QB2425YY					
			POLYON™	2200	61PU10Q+2425YY				G, V	
			ENERGY SAVER POLYON™	2400	61SW10QU2425YY			61SW10QU7025YY		
			SEMI-STEEL	2000	61SS10QS2425YY					
3		DUCTILE	4500	61DS10QR2425YY						
		MOLD-ON RUBBER	1100	61RS10LB2425YY			61RS10LB7025YY			
		SUPREME RUBBER™	1300			61RH10LS7025YY				
		PHENOLIC	2900	61PH10LB2425YY						
		HIGH-TEMP PHENOLIC	2400	61HT10LQ2425YY						
		EPOXY	2400	61OV10LQ2425YY						
		POLYON™	3000	61PU10L+2425YY	61PU10LG6525YY			G, V		
		ENERGY SAVER POLYON™	3000	61SW10LU2425YY			61SW10LU7025YY			
		ULTRAPOLY™	4000	61EX10LG2425YY	61EX10LG6525YY	61EX10LG7025YY				
		ERGOLASTOMER™	3200		61HU10LI6525YY					
		TITAN™ POLYMER	6000		61PX10LO6525YY	61PX10LO7925YY				
		IRONMAN	7000		61NX10LB6525YY					
		SEMI-STEEL	2500	61SS10LS2425YY						
		DUCTILE	6000	61DS10LR2425YY	61DS10LR6525YY	61DS10LR7025YY	*7000			
		ENERGY SAVER DUCTILE™	6000	61CD10LR2425YY		61CD10LR7025YY	*7000			
		FORGED STEEL	6000	61FS10LS2725YY		61FS10LS7925YY	*7000			
IRON V-GROOVE	3500	61VG10L+2425YY				T, W				

\*Load capacity with tapered bearings



# DURABLE SUPERIOR CASTERS®

61/62 – HEAVY DUTY KINGPINLESS SERIES – 7,000 LB

Wheel Diameter	Tread Width	Wheel Type	Load Capacity	Add options by replacing YY in part # with option designators.			*Load Cap.	+ Color	Overall Height	Swivel Radius
				61 Series Swivel Caster Part # To order rigid casters, change part # prefix 61 to 62.						
				Roller Bearings 24, 27	Sealed Precision BB 65	Tapered Bearing 70, 79				
10	3	DUCTILE IRON V-GROOVE	6000	61DV10L+2425YY	61DV10L+6525YY	61DV10L+7025YY	*7000	T, W	12-1/2	8-1/32
	2X1.5	DW	5200 4600			61DW10LBT425YY 61DW10LGT425YY				
12	YOKE ONLY			61ZZ12LZ8825YY					15-1/2	10-1/32
	2-1/2	MOLD-ON RUBBER	1200	61RS12QB2425YY						
		PHENOLIC	3000	61PH12QB2425YY						
		POLYON™	2500	61PU12QB2425YY						
		ENERGY SAVER POLYON™	2700	61SW12QU2425YY						
		SEMI-STEEL	2000	61SS12QS2425YY						
	3	MOLD-ON RUBBER	1300	61RS12LB2425YY						
		SUPREME RUBBER™	1400			61RH12LS7025YY				
		EPOXY	2600	61OV12LQ2425YY						
		PHENOLIC	3500	61PH12LB2425YY						
		POLYON™	3500	61PU12L+2425YY	61PU12LG6525YY			G, V		
		ENERGY SAVER POLYON™	3500	61SW12LU2425YY		61SW12LU7025YY				
		ULTRAPOLY™	5000	61EX12LG2425YY	61EX12LG6525YY	61EX12LG7025YY				
		TITAN™ POLYMER	6500		61PX12LO6525YY	61PX12LO7925YY				
		IRONMAN	7000		61NX12LB6525YY					
		SEMI-STEEL	2500	61SS12LS2425YY						
		DUCTILE	6000	61DS12LR2425YY	61DS12LR6525YY	61DS12LR7025YY	*7000			
ENERGY SAVER DUCTILE™		6000	61CD12LR2425YY		61CD12LR7025YY	*7000				
FORGED STEEL	6000	61FS12LS2725YY		61FS12LS7925YY	*7000					

\*Load capacity with tapered bearings

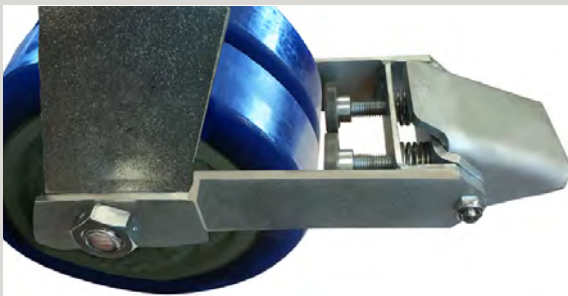

## FIELD INSTALLABLE BRAKES ARE NOW AVAILABLE!

*Please turn to page number 173 to view all available brake options.*

# 63/64 – EXTREME DUTY KINGPINLESS SERIES – 20,000 LB



- ASTM1045 steel, drop forged 1/2" thick swivel head, 4-1/2" diameter precisely machined raceway of 5/8" diameter harden steel ball bearings.
- Legs are formed from 3/8" thick steel, double welded
- 1" grade 5 axle bolt for 3" wide wheels
- 1-1/4" grade 8 machined axle bolt for 4" wide wheels
- Zinc-plated
- Grease fitting on raceway and axle

**BRAKE OPT.**



Face Contact Brake (F)



T Handle Brake (R)

**OTHER OPTIONS**



Reinforced leg base. Cross bar welded between leg base offers added strength against failure.



Toe Guard



4-Position Lock Bolt-on. Order Separately Part # 4PSL63

**FASTENING PATTERN**

Plate Code	Overall Size	Bolt Holes Pattern	Mounting Bolt Size
30	6-1/4 X 7-1/2	4-1/2 X 6 SLOTTED TO 4-1/8 X 6-1/8	1/2 TO 9/16

63/64 – EXTREME DUTY KINGPINLESS SERIES – 20,000 LB

Wheel Dia.	Tread Width	Wheel Type	63 Series Swivel Casters Part # <i>To order rigid casters, change part # prefix 63 to 64.</i>					+ Color	Overall Height	Swivel Radius		
			Roller Bearings 26, 27, 33	Weight Capacity	Tapered Bearing 71, 74	Weight Capacity	Sealed Precision BB 68				Weight Capacity	
6	3	YOKE ONLY	63ZZ60LZ7130YY						G, V	8-1/2	4-3/4	
		MOLD-ON RUBBER	63RS60LB2630YY	750								
		SUPREME RUBBER	63RH60LS2630YY	850	63RH60LS7130YY	850	63RH60LS6830YY	850				
		PHENOLIC	63PH60LB2630YY	2000								
		POLYON™	63PU60L+2630YY	2000								
		ENERGY SAVER POLYON™	63SW60LU2630YY	2200	63SW60LU7130YY	2200						
	2 X 1.5	DW					63EX60LG6830YY	3000				
							63DW60LBT530YY	3900				
							63DW60LG6T50YY	3500				
		TITAN™ POLYMER IRONMAN			63PX60LO7130YY	4000	63PX60LO6830YY	4000				
		SEMI-STEEL	63SS60LS2630YY	2500			63NX60LB6830YY	7200				
		DUCTILE	63DS60LR2630YY	6000	63DS60LR7130YY	10000	63DS60LR6830YY	6000				
		ENERGY SAVER DUCTILE™	63CD60LR2630YY	6000	63CD60LR7130YY	10000	63CD60LR6830YY	8000				
		FORGED STEEL	63FS60LS2730YY	8000	63FS60LS7130YY	10000						
IRON V-GROOVE	63VG60L+2630YY	3500					T, W					
DUCTILE V-GROOVE	63DV60L+2630YY	5000	60DV60L+7130YY	5000			T, W					
FORGED V-GROOVE	63FV60LW2630YY	6000	63FV60LW7130YY	10000								
8	3	YOKE ONLY	63ZZ80LZ7130YY						G, V	10-1/2	6-3/16	
		MOLD-ON RUBBER	63RS80LB2630YY	900								
		SUPREME RUBBER	63RH80LS2630YY	1000	63RH80LS7130YY	1000	63RH80LS6830YY	1000				
		PHENOLIC	63PH80LB2630YY	2500								
		HIGH-TEMP PHENOLIC	63HT80LQ2630YY	1900								
		POLYON™	63PU80L+2630YY	2500								
	2 X 1.5	DW					63EX80LG6830YY	3500				
							63DW80LBT530YY	4500				
							63DW80LGT530YY	4000				
		TITAN™ POLYMER IRONMAN			63PX80LG7130YY	5500	63PX80LG6830YY	5500				
		SEMI-STEEL	63SS80LS2630YY	2500			63NX80LB6830YY	7200				
		DUCTILE	63DS80LR2630YY	6000	63DS80LR7130YY	10000	63DS80LR6830YY	6000				
		ENERGY SAVER DUCTILE™	63CD80LR2630YY	6000	63CD80LR7130YY	10000						
		FORGED STEEL	63FS80LS2730YY	8000	63FS80LS7130YY	11000						
IRON V-GROOVE	63VG80L+2630YY	3500					T, W					
DUCTILE V-GROOVE	63DV80L+2630YY	5000	63DV80L+7130YY	5000			T, W					



# DURABLE SUPERIOR CASTERS®

63/64 – EXTREME DUTY KINGPINLESS SERIES – 20,000 LB

Wheel Dia.	Tread Width	Wheel Type	63 Series Swivel Casters Part # <i>To order rigid casters, change part # prefix 63 to 64.</i>					+ Color	Overall Height	Swivel Radius
			Roller Bearings 26, 27, 33	Weight Capacity	Tapered Bearing 71, 74	Weight Capacity	Sealed Precision BB 68			
8	3	FORGED V-GROOVE			63FV80LW7130YY	10000			10-1/2	6-3/16
		YOKE ONLY	63ZZ80NZ7430YY							
	4	ULTRAPOLY™	63EX80NG3330YY	4000	63EX80NG7430YY	4000	63EX80NG6830YY	4000		
		DW				63DW80NB630YY	4000	63DW80NG6T60YY		
	4	TITAN™ POLYMER			63PX80NO7430YY	6500	63PX80NO6830YY	6500		
		IRONMAN					63NX80NB6830YY	8000		
		DUCTILE	63DS80NR3330YY	10000	63DS80NR7430YY	17000	63DS80NR6830YY	10000		
		FORGED STEEL	63FS80NS3330YY	11000	63FS80NS7430YY	18000				
10	3	FORGED V-GROOVE	63FV80NW3330YY	6000	63FV80NW74YY	10000				
		YOKE ONLY	63ZZ10LZ7130YY							
		MOLD-ON RUBBER	63RS10LB2630YY	1100						
		SUPREME RUBBER	63RH10LS2630YY	1300	63RH10LS7130YY	1300	63RH10LS6830YY	1300		
		PHENOLIC	63PH10LB2630YY	2900						
		HIGH-TEMP PHENOLIC	63HT10LQ2630YY	2400						
	3	POLYON™	63PU10L+2630YY	3000						
		ENERGY SAVER POLYON™	63SW10LU2630YY	3000	63SW10LU7130YY	3000				
		ULTRAPOLY™	63EX10LG2630YY	4000	63EX10LG7130YY	4000	63EX10LG6830YY	4000		
		DW					63DW10LBT530YY	5200		
							63DW10LGT530YY	4600		
							63PX10LO6830YY	6000		
4	2 X 1.5	TITAN™ POLYMER			63PX10LO7130YY	6000	63PX10LO6830YY	6000		
		IRONMAN					63NX10LG6830YY	7200		
	3	SEMI-STEEL	63SS10LS2630YY	2500						
		DUCTILE	63DS10LR2630YY	7000	63DS10LR7130YY	10000	63DS10LR6830YY	8000		
		ENERGY SAVER DUCTILE™	63CD10LR2630YY	7000	63CD10LR7130YY	10000				
		FORGED STEEL	63FS10LS2730YY	8000	63FS10LS7130YY	10000				
		IRON V-GROOVE	63VG10L+2630YY	3500						
		DUCTILE V-GROOVE	63DV10L+2630YY	6000	63DV10L+7130YY	7000				
		YOKE ONLY	63ZZ10NZ7430YY							
		MOLD-ON RUBBER	63RS10NB3330YY	1400						
ULTRAPOLY™	63EX10NG3330YY	5500	63EX10NG7430YY	5500	63EX10NG6830YY	5500				
12	2 X 2	DW					63DW10NB630YY	4500		
							63DW10NGT630YY	5000		
	4	TITAN™ POLYMER			63PX10NG7430YY	7000	63PX10NG6830YY	7000		
		IRONMAN					63NX10NG6830YY	8000		
		DUCTILE	63DS10NR3330YY	10000	63DS10NR7430YY	17000	63DS10NR6830YY	10000		
		FORGED STEEL	63FS10NS3330YY	11000	63FS10NS7430YY	20000				
	3-1/2	3	FORGED V-GROOVE	63FV10NW7430YY	15000					
			YOKE ONLY	63ZZ12LZ7130YY						
			MOLD-ON RUBBER	63RS12LB2630YY	1300					
			SUPREME RUBBER	63RH12LS2630YY	1400	63RH12LS7130YY	1400	63RH12LS6830YY		
PHENOLIC			63PH12LB2630YY	3500						
POLYON™			63PU12L+2630YY	3500						
4		ENERGY SAVER POLYON™	63SW12LU2630YY	3500	63SW12LU7130YY	3500				
		ULTRAPOLY™	63EX12LG2630YY	5000	63EX12LG7130YY	5000	63EX12LG6830YY	5000		
		TITAN™ POLYMER			63PX12LO7130YY	6500	63PX12LO6830YY	6500		
		IRONMAN					63NX12LB6830YY	7200		
		SEMI-STEEL	63SS12LS2630YY	2500						
		DUCTILE	63DS12LR2630YY	6000	63DS12LR7130YY	10000	63DS12LR6830YY	8000		
		ENERGY SAVER DUCTILE™	63CD12LR2630YY	6000	63CD12LR7130YY	10000				
		FORGED STEEL	63FS12LS2730YY	8000	63FS12LS7130YY	10000	63FS12LS6830YY	8000		
4	3-1/2	YOKE ONLY	63ZZ12NZ7430YY							
		SUPREME RUBBER	63RH12MS3330YY	1500	63RH12MS7430YY	1500				
	4	HIGH-TEMP PHENOLIC	63HT12MB3330YY	3000						
		PHENOLIC	63PH12MB3330YY	4000						
		MOLD-ON RUBBER	63RS12NB3330YY	1500						
		ULTRAPOLY™	63EX12NG3330YY	6500	63EX12NG7430YY	6500	63EX12NG6830YY	6500		
		TITAN™ POLYMER			63PX12NG7430YY	8000	63PX12NG6830YY	8000		
		IRONMAN					63NX12NB6830YY	8000		
16	3	PHENOLIC	63PH12NB3330YY	6500						
		DUCTILE	63DS12NR3330YY	10000	63DS12NR7430YY	17000	63DS12NR6830YY	11000		
	FORGED STEEL	63FS12NS3330YY	11000	63FS12NS7430YY	20000					
	YOKE ONLY	63ZZ16LZ7130YY								
	4	MOLD-ON RUBBER	63RS16LB2630YY	1500						
		PHENOLIC	63PH16LB2630YY	4000						
		POLYON™	63PU16LG2630YY	4400						



## 65/66 – EXTREME DUTY KINGPINLESS SERIES – 20,000 LB



- ASTM1045 steel, drop forged 5/8" thick swivel head, 7" diameter precisely machined raceway of 3/4" diameter harden steel ball bearings.
- Legs are formed from 1/2" thick steel, double welded
- 1-1/4" grade 8 machined axle bolt
- Zinc-plated finish
- Grease fitting on raceway and axle

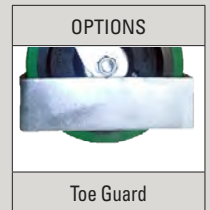

FASTENING PATTERN			
Plate Code	Overall Size	Bolt Hole Pattern	Mounting Bolt Size
45	8-1/2 X 8-1/2	7 X 7	5/8

65/66 – EXTREME DUTY KINGPINLESS SERIES – 20,000 LB

Wheel Diameter	Tread Width	Wheel Type	65 Series Swivel Casters Part # <i>To order rigid casters, change part # prefix 65 to 66.</i>						Overall Height	Swivel Radius	
			Roller Bearings 33	Weight Capacity	Tapered Bearing 74	Weight Capacity	Sealed Precision BB 68	Weight Capacity			
8	4	YOKE ONLY	65ZZ80NZ7445YY						11	6	
		ULTRAPOLY™	65EX80NG3345YY	4000	65EX80NG7445YY	4000	65EX80NG6845YY	4000			
	2 X 2	DW					65DW80NB645YY	5200			
							65DW80NGT645YY	4700			
	4	4	TITAN™ POLYMER			65PX80NO7445YY	6500	65PX80NO6845YY			6500
			IRONMAN™					65NX80NB6845YY			8000
			DUCTILE	65DS80NR3345YY	10000	65DS80NR7445YY	17000	65DS80NR6845YY			10000
10	4	FORGED STEEL	65FS80NS3345YY	11000	65FS80NS7445YY	18000					
		FORGED V-GROOVE	65FV80NW3345YY	6000	65FV80NW7445YY	10000					
		YOKE ONLY	65ZZ10NZ7445YY								
	2 X 2	4	MOLD-ON RUBBER	65RS10NB3345YY	1400						
			ULTRAPOLY™	65EX10NG3345YY	5500	65EX10NG7445YY	5500	65EX10NG6845YY	5500		
		4	DW					65DW10NB645YY	7000		
								65DW10NGT645YY	6400		
12	3-1/2	TITAN™ POLYMER			65PX10NO7445YY	7000	65PX10NO6845YY	7000			
		IRONMAN™					65NX10NB6845YY	8000			
		DUCTILE	65DS10NR3345YY	10000	65DS10NR7445YY	17000	65DS10NR6845YY	10000			
	4	FORGED STEEL	65FS10NS3345YY	11000	65FS10NS7445YY	20000					
		FORGED V-GROOVE			65FV10NW7445YY	1500					
		YOKE ONLY	65ZZ12NZ7445YY								
		SUPREME RUBBER	65RH12MS3345YY	1500	65RH12MS7445YY	1500					
4	H. T. PHENOLIC	65HT12MB3345YY	3000								
	PHENOLIC	65PH12MB3345YY	4000								
	MOLD-ON RUBBER	65RS12NB3345YY	1500								
	ULTRAPOLY™	65EX12NG3345YY	6500	65EX12NG7445YY	6500	65EX12NG6845YY	6500				
	TITAN™ POLYMER			65PX12NO7445YY	8000	65PX12NO6845YY	8000				
4	IRONMAN™					65NX12NB6845YY	8000				
	DUCTILE	65DS12NR3345YY	11000	65DS12NR7445YY	17000	65DS12NR6845YY	11000				
	FORGED STEEL	65FS12NS3345YY	11000	65FS12NS7445YY	20000						

## D1/R1 – DUAL WHEEL KINGPINLESS SERIES – 6,000 LB

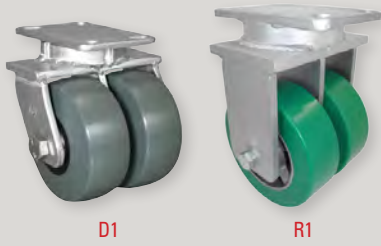

- Constructed 5/16" thick top plate from hot forged ASTM1045 steel
- Integrated with a 3" diameter, precisely machined raceway of 1/2" ball bearings
- Grease fitting on raceway and axle
- 1/2" CNC machined grade 5 axle bolt and lock nuts
- Zinc-plated finish

<b>BRAKE OPT.</b>	<b>OTHER OPTIONS</b>
<b>Face Contact Brake (F)</b>	
<b>T Handle Brake</b> 1 Side =(R) 2 Sides =(W)	<b>4-Position Lock Bolt-on.</b> Order Separately Part # 4PSL57

FASTENING PATTERN			
Plate Code	Overall Size	Bolt Hole Pattern	Mounting Bolt Size
19	4-1/2 X 6-1/4	2-7/16 X 4-15/16 TO 3-3/8 X 5-1/4	3/8

WHEEL DIAMETER, OVERALL HEIGHT AND SWIVEL RADIUS		
Wheel Diameter	Overall Height	Swivel Radius
4	7	4-1/4
5	7-1/2	4-5/8
6	8	5-1/8
8	10-1/8	6-3/4

### D1/R1 – DUAL WHEEL KINGPINLESS SERIES – 6,000 LB

Wheel Diameter	Thread Width	Wheel Type	Available Bearing Options	Load Cap.	When multiple bearings choices exist, replace ## with desired bearings code.					+ Color
					D1 Series Swivel Caster Part # To order rigid casters, change part # prefix D1 to R1.					
					Roller Bearing 4	Caged Roller Bearing 09	Tapered Bearing 73	Sealed Precision BB 48, 60, 63, T3, 65	Delrin, Bronze and Plain 11, 12, 56, 57, 88, 96, B1, B5	
4	2 X 2	YOKE ONLY			D1ZZ40JZ8319YY					
		NEO-ENERGIZER™	04, 09, 60	1000	D1EN40JB0419YY	D1EN40JB0919YY		D1EN40JB6019YY	D1EN40JB##19YY	
		NOMADIC™	04, 09, 60, 48, 57	800	D1NM40J+0419YY	D1NM40JB0919YY		D1NM40JB6019YY	D1NM40J+##19YY	I, B
		RUBBER ON NYLON	04, 09, 60, 48, 57	800	D1NR40JB0419YY	D1NR40J+0919YY		D1NR40J+6019YY	D1NR40JB##19YY	
		RUBBER ON ALUMINUM	04, 09, 60, 48, 57	800	D1RA40JB0419YY	D1RA40JB0919YY		D1RA40JB6019YY	D1RA40JB##19YY	
		LOW PROFILE RUBBER		600	D1LP40JB0419YY	D1LP40JB0919YY		D1LP40JB6019YY	D1LP40JB##19YY	
		MOLD-ON RUBBER	04, 09, 60, 48, 57	800	D1RS40JB0419YY	D1RS40JB0919YY		D1RS40JB6019YY	D1RS40JB##19YY	
		THERMO-PRO™	04, 09, 60, 63, 48, 57	600	D1TP40J+0419YY	D1TP40J+0919YY		D1TP40J+6019YY	D1TP40J+##19YY	A, T, Y
		POLYOLEFIN	04, 09, 60, 63, 48, 57	1000	D1PO40J+0419YY	D1PO40J+0919YY		D1PO40J+6019YY	D1PO40J+##19YY	B, E
		NYLON	04, 09, 60, 63, 48, 57	1600	D1NY40JE0419YY	D1NY40JE0919YY		D1NY40JE6019YY	D1NY40JE##19YY	
		IRONMAN	04, 09, 73, 65	4400	D1NX40JB0419YY	D1NX40JB0919YY	D1NX40JB7319YY	D1NX40JB6519YY	D1NX40JB##19YY	
		ROKHARD™	04, 09, 60, 63, 48, 57	1600	D1HI40JB0419YY	D1HI40JB0919YY		D1HI40JB6019YY	D1HI40JB##19YY	
		BRIMSTONE®	04, 09, 90	1600	D1GN40JQ0419YY	D1GN40JQ0919YY		D1GN40JQ6019YY	D1GN40JQ##19YY	
		EPOXY	04, 09, 90	1600	D1OV40JQ0419YY	D1OV40JQ0919YY		D1OV40JQ6019YY	D1OV40JQ##19YY	
		MAXROK™	04, 09, 60, 63, 48, 57	1600	D1MA40JB0419YY	D1MA40JB0919YY		D1MA40JB6019YY	D1MA40JB##19YY	
		PHENOLIC	04, 09, 60, 63, 48, 57	1600	D1PH40JB0419YY	D1PH40JB0919YY		D1PH40JB6019YY	D1PH40JB##19YY	
		PHENOLIC (STRAIGHT SIDED)	04, 09, 60, 57, 12	2000	D1PH40TB0419YY	D1PH40TB0919YY		D1PH40TB6019YY	D1PH40TB##19YY	
		HIGH-TEMP PHENOLIC	04, 09, 90	1200	D1HT40JQ0419YY	D1HT40JQ0919YY		D1HT40JQ6019YY	D1HT40JQ##19YY	
		POLYON MAXROK™	04, 09, 60, 63, 48, 57	1400	D1MU40J+0419YY	D1MU40J+0919YY		D1MU40J+6019YY	D1MU40J+##19YY	G, K
		POLY AL™	04, 09, 60, 63, 48, 57	1600	D1PA40J+0419YY	D1PA40J+0919YY		D1PA40J+6019YY	D1PA40J+##19YY	N, R
DW-BLACK		940				D1DW40JLT319YY				
DW-RED		1300				D1DW40JRT319YY				
DW-BLUE		1920				D1DW40JBT319YY				
DW-GRAY		2000				D1DW40JGT319YY				

D1/R1 – DUAL WHEEL KINGPINLESS SERIES – 6,000 LB

Wheel Diameter	Thread Width	Wheel Type	Available Bearing Options	Load Cap.	When multiple bearings choices exist, replace ## with desired bearings code.					+ Color
					D1 Series Swivel Caster Part # To order rigid casters, change part # prefix D1 to R1.					
					Roller Bearing 4	Caged Roller Bearing 09	Tapered Bearing 73	Sealed Precision BB 48, 60, 63, T3, 65	Delrin, Bronze and Plain 11, 12, 56, 57, 88, 96, B1, B5	
4	2 X 2	POLY-PRO™	04, 09, 60, 63, 48, 57	1000	D1PP40J+0419YY	D1PP40J+0919YY		D1PP40J+6019YY	D1PP40J+##19YY	D, K, M, U, W
				1200				D1PP40JP4919YY		
		POLYMAX™	04, 09, 60, 63, 48, 57	1200	D1PM40J+0419YY	D1PM40J+0919YY		D1PM40J+6019YY	D1PM40J+##19YY	I, M
			04, 09, 60	1600	D1PU40J+0419YY	D1PU40J+0919YY		D1PU40J+6019YY	D1PU40J+##19YY	G, V
		POLYON™		1600				D1PU40JV6319YY		
			04, 09, 60, 73	1600	D1SW40JU0419YY	D1SW40JU0919YY	D1SW40JU7319YY	D1SW40JU6019YY	D1SW40JU##19YY	
		POLYFLEXON™ CAST	04, 09, 60, 63, 48, 57	1400	D1RP40JK0419YY	D1RP40JK0919YY		D1RP40JK6019YY	D1RP40JK##19YY	
		POLYFLEXON™		1800				D1UA40J+6419YY		N, O
		D-POLYON		1800				D1UD40JL6419YY		
		ULTRAFLEX™		1800		D1UX40J06319YY				
		DURALASTOMER™	09, 60, 57	1500	D1SU40JL0419YY	D1SU40JL0919YY		D1SU40JL6019YY	D1SU40JL##19YY	
		SUPER ELASTOMER		2400				D1EE40J16019YY		
		ERGOLASTOMER™	04, 09, 73, 64, 57	2000	D1HU40JI0419YY	D1HU40JI0919YY	D1HU40JI7319YY	D1HU40JI6019YY	D1HU40JI##19YY	
		SEMI-STEEL	04, 09	1400	D1SS40JS0419YY	D1SS40JS0919YY		D1SS40JS6019YY	D1SS40JS##19YY	
		HEAVY DUTY IRON	04, 09, 63	1900	D1HS40JS0419YY	D1HS40JS0919YY		D1HS40JS6019YY	D1HS40JS##19YY	
		DUCTILE	04, 09, 63, 73	3000	D1DS40JR0419YY	D1DS40JR0919YY		D1DS40JR6019YY	D1DS40JR##19YY	
		SOLID STEEL	09, B1, B5	5000	D1MS40JS0419YY	D1MS40JS0919YY		D1MS40JS6019YY	D1MS40JS##19YY	
		ENERGY SAVER DUCTILE™	04, 09, B1, B5	3000	D1CD40JR0419YY	D1CD40JR0919YY		D1CD40JR6019YY	D1CD40JR##19YY	
		MAXROK™	04, 09, 60, 57	1600	D1MV40JT0419YY	D1MV40JT0919YY		D1MV40JT6019YY	D1MV40JT##19YY	
		5	2 X 2	YOKE ONLY				D1ZZ50JZ8319YY		
NEO-ENERGIZER™	04, 09, 60'			1100	D1EN50JB0419YY	D1EN50JB0919YY		D1EN50JB6019YY	D1EN50JB##19YY	
NOMADIC™	04, 09, 48, 60, 57			1000	D1NM50J+0419YY	D1NM50J+0919YY		D1NM50J+6019YY	D1NM50J+##19YY	B, I
RUBBER ON NYLON	04, 09, 48, 60, 57			900	D1NR50JB0419YY	D1NR50JB0919YY		D1NR50JB6019YY	D1NR50JB##19YY	
RUBBER ON ALUMINUM	04, 09, 48, 60, 57			1000	D1RA50JB0419YY	D1RA50JB0919YY		D1RA50JB6019YY	D1RA50JB##19YY	
MOLD-ON RUBBER CUSHENDURE™	04, 09, 60, 48, 57			800	D1RS50JB0419YY	D1RS50JB0919YY		D1RS50JB6019YY	D1RS50JB##19YY	
				800				D1GR50JB1919YY		
THERMO-PRO™	04, 09, 60, 48, 63, 57			700	D1TP50J+0419YY	D1TP50J+0919YY		D1TP50J+6019YY	D1TP50J+##19YY	A, I, T, X, Y, Z
POLYOLEFIN				1300	D1PO50J+0419YY				D1PO50J+##19YY	B, E
NYLON	04, 09, 60, 48, 53, P3, 57			1900	D1NY50JE0419YY	D1NY50JE0919YY		D1NY50JE6019YY	D1NY50JE##19YY	
IRONMAN	65, 73			4400			D1NX50JB7319YY	D1NX50JB6519YY		
ROK HARD™	04, 09, 48, 60, 57			1800	D1HI50JB0419YY	D1HI50JB0919YY		D1HI50JB6019YY	D1HI50JB##19YY	
BRIMSTONE®	04, 09, 60, 90			2000	D1GN50JQ0419YY	D1GN50JQ0919YY		D1GN50JQ6019YY	D1GN50JQ##19YY	
EPOXY	04, 09, 90			2000	D1OV50JQ0419YY	D1OV50JQ0919YY		D1OV50JQ6019YY	D1OV50JQ##19YY	
MAXROK™	04, 09, 60, 48, 57			2000	D1MA50JB0419YY	D1MA50JB0919YY		D1MA50JB6019YY	D1MA50JB##19YY	
PHENOLIC	04, 09, 60, 48, 57, 90			2000	D1PH50JB0419YY	D1PH50JB0919YY		D1PH50JB6019YY	D1PH50JB##19YY	
H-TEMP PHENOLIC STEROLLIZER™	04, 09, 90			1500	D1HT50JQ0419YY	D1HT50JQ0919YY		D1HT50JQ6019YY	D1HT50JQ##19YY	
POLYON MAXROK™	04, 09, 48, 60, 57			2000	D1MU50J+0419YY	D1MU50J+0919YY		D1MU50J+6019YY	D1MU50J+##19YY	G, K
POLYON AL™	04, 09, 48, 60, 57			1800	D1PA50J+0419YY	D1PA50J+0919YY		D1PA50J+6019YY	D1PA50J+##19YY	N, R
POLYON - C	04, 09, 48, 60, 57, 12			1800	D1PR50JL0419YY	D1PR50JL0919YY		D1PR50JL6019YY	D1PR50JL##19YY	
DW-BLACK				1100				D1DW50JLT319YY		
DW-RED				1500				D1DW50JRT319YY		
DW-BLUE				1320				D1DW50JBT319YY		
DW-GRAY				2400				D1DW50JGT319YY		
POLY-PRO™	04, 09, 48, 60, 63, 57			1200	D1PP50J+0419YY	D1PP50J+0919YY		D1PP50J+6019YY	D1PP50J+##19YY	B, C, D, K, U, M, W
				1400				D1PP50JP4919YY		
								D1PP50JH6319YY		
POLYMAX™	04, 09, 48, 60, 63, 57			1500	D1PM50J+0419YY	D1PM50J+0919YY		D1PM50J+6019YY	D1PM50J+##19YY	I, M
POLYON™				2200				D1PU50JV6319YY		
	04, 09, 60, 48			2200	D1PU50J+0419YY	D1PU50J+0919YY		D1PU50J+6019YY	D1PU50J+##19YY	G, V
ENERGY SAVER POLYON™	04, 09, 60, 48			2600	D1SW50JU0419YY	D1SW50JU0919YY		D1SW50JU6019YY	D1SW50JU##19YY	
POLYFLEXON™ CAST	04, 09, 60, 48			1600	D1RP50JK0419YY	D1RP50JK0919YY		D1RP50JK6019YY	D1RP50JK##19YY	
POLYFLEXON™				1800				D1UA50J+6419YY		N, O
D-POLYON				1800				D1UD50JL6419YY		



# DURABLE SUPERIOR CASTERS®

D1/R1 – DUAL WHEEL KINGPINLESS SERIES – 6,000 LB

Wheel Diameter	Thread Width	Wheel Type	Available Bearing Options	Load Cap.	When multiple bearings choices exist, replace ## with desired bearings code.					+ Color
					D1 Series Swivel Caster Part # To order rigid casters, change part # prefix D1 to R1.					
					Roller Bearing 4	Caged Roller Bearing 09	Tapered Bearing 73	Sealed Precision BB 48, 60, 63, T3, 65	Delrin, Bronze and Plain 11, 12, 56, 57, 88, 96, B1, B5	
5	2 X 2	ULTRAFLEX™		1800		D1UX50J06419YY				
		DURALASTOMER™	09, 60, 57	1800	D1SU50JL0419YY	D1SU50JL0919YY		D1SU50JL6019YY	D1SU50JL##19YY	
		SUPER ELASTOMER		2400				D1EE60J16019YY		
		ERGOLASTOMER™	04, 09, 73, 64, 57	2800	D1HU50JI0419YY	D1HU50JI0919YY	D1HU50JI7319YY	D1HU50JI6019YY	D1HU50JI##19YY	
		SEMI-STEEL	04, 09	2000	D1SS50JS0419YY	D1SS50JS0919YY		D1SS50JS6019YY	D1SS50JS##19YY	
		HEAVY DUTY IRON	04, 09, 63	2400	D1HS50JS0419YY	D1HS50JS0919YY		D1HS50JS6019YY	D1HS50JS##19YY	
		DUCTILE	04, 09, 73, 63, B1, B5	3000	D1DS50JR0419YY	D1DS50JR0919YY	D1DS50JR7319YY	D1DS50JR6019YY	D1DS50JR##19YY	
		FORGED STEEL	04, 09, B5, B1	5000	D1FS50JS0419YY	D1FS50JS0919YY		D1FS50JS6019YY	D1FS50JS##19YY	
		ENERGY SAVER DUCTILE™	04, 09, B1, B5	3000	D1CD50JR0419YY	D1CD50JR0919YY		D1CD50JR6019YY	D1CD50JR##19YY	
		YOKE ONLY				D1ZZ60JZ8319YY				D1ZZ60JZ8319YY
6	2 X 2	NEO-ENERGIZER™	04, 09, 60	1200	D1EN60JB0419YY	D1EN60JB0919YY		D1EN60JB6019YY	D1EN60JB##19YY	
		PNEUMATIC		400				D1FP60JB6019YY		
		FOAM FILLED		400				D1FF60JB6019YY		
		EVER-ROLL™		400				D1ER60J+6019YY		B, I
		NOMADIC™	04, 09, 48, 60, 57	1200	D1NM60JB0419YY	D1NM60JB0919YY		D1NM60JB6019YY	D1NM60JB##19YY	
		RUBBER ON NYLON	04, 09, 48, 60, 57	1100	D1NR60JB0419YY	D1NR60JB0919YY		D1NR60JB6019YY	D1NR60JB##19YY	
		DURA-CUSHION™	04, 09, 63	700	D1BC60J+0419YY	D1BC60J+0919YY		D1BC60J+6019YY	D1BC60J+##19YY	X, Z
		ECO-RUBBER	53, P3	700	D1SN60JC0419YY	D1SN60JC0919YY		D1SN60JC6019YY	D1SN60JC##19YY	
		RUBBER ON ALUMINUM	04, 09, 48, 60, 57	1100	D1RA60JB0419YY	D1RA60JB0919YY		D1RA60JB6019YY	D1RA60JB##19YY	
		LOW PROFILE RUBBER		1200	D1LP60JB0419YY				D1LP60JB##19YY	
		MOLD-ON RUBBER	04, 09, 48, 60, 57	1100	D1RS60JB0417Y	D1RS60JB0417Y		D1RS60JB0417Y	D1RS60JB0417Y	
		SUPREME RUBBER	63, 73	1400	D1RH60JS0419YY	D1RH60JS0919YY	D1RH60JS7319YY	D1RH60JS6019YY	D1RH60JS##19YY	
		THERMO-PRO™	04, 09, 60, 63, 48, 57	1000	D1TP60J+0419YY	D1TP60J+0919YY		D1TP60J+6019YY	D1TP60J+##19YY	A, I, T, X, Y, Z
		POLYOLEFIN	04, 09, 60, 53, P3, 48, 57	1400	D1PO60J+0419YY	D1PO60J+0919YY		D1PO60J+6019YY	D1PO60J+##19YY	B, E
		NYLON	04, 09, 48, 60, 57	2000	D1NY60JE0419YY	D1NY60JE0919YY		D1NY60JE6019YY	D1NY60JE##19YY	
		IRONMAN		4400				D1NX60JB6519YY		
		ROKHARD™	04, 09, 48, 60, 57	2000	D1HI60JB0419YY	D1HI60JB0919YY		D1HI60JB6019YY	D1HI60JB##19YY	
		BRIMSTONE®	04, 09, 60, 90	2200	D1GN60JQ0419YY	D1GN60JQ0919YY		D1GN60JQ6019YY	D1GN60JQ##19YY	
		EPOXY	04, 09, 90	2200	D1OV60JQ0419YY	D1OV60JQ0919YY		D1OV60JQ6019YY	D1OV60JQ##19YY	
		MAXROK™	04, 09, 60, 48, 57	2400	D1MA60JB0419YY	D1MA60JB0919YY		D1MA60JB6019YY	D1MA60JB##19YY	
		PHENOLIC	04, 09, 60, 48, 57	2400	D1PH60JB0419YY	D1PH60JB0919YY		D1PH60JB6019YY	D1PH60JB##19YY	
		PHENOLIC (STRAIGHT SIDED)		3000	D1PH60TB0419YY	D1PH60TB0919YY		D1PH60TB6019YY	D1PH60TB##19YY	
		HIGH-TEMP PHENOLIC	04, 09, 90	2000	D1HT60JQ0419YY	D1HT60JQ0919YY		D1HT60JQ6019YY	D1HT60JQ##19YY	
		POLY MAXROK™	04, 09, 60, 48, 57	2200	D1MU60J+0419YY	D1MU60J+0919YY		D1MU60J+6019YY	D1MU60J+##19YY	G, K
		POLYON AL™	04, 09, 48, 60, 57	2200	D1PA60J+0419YY	D1PA60J+0919YY		D1PA60J+6019YY	D1PA60J+##19YY	N, R
		POLYON-C	04, 09, 48, 60, 57, 12	2400	D1PR60JL0419YY	D1PR60JL0919YY		D1PR60JL6019YY	D1PR60JL##19YY	
		DW-BLACK		1400				D1DW60JLT319YY		
		DW-RED		1920				D1DW60JRT319YY		
		DW-BLUE		2800				D1DW60JBT319YY		
		DW-GRAY		2880				D1DW60JGT319YY		
		POLY-PRO™	04, 09, 48, 60, 57	1440	D1PP60J+0419YY	D1PP60J+0919YY		D1PP60J+6019YY	D1PP60J+##19YY	D, I, K, M, W, U
				1800				D1PP60JP4919YY		
								D1PP60JH6319YY		
		POLYMAX™	04, 09, 48, 60, 63, 57	1800	D1PM60J+0419YY	D1PM60J+0919YY		D1PM60J+6019YY	D1PM60J+##19YY	I, M
		POLYON™		2400	D1PU60JV6319YY			D1PU60JV6319YY	D1PU60JV6319YY	
			04, 09, 60		D1PU60J+0419YY	D1PU60J+0919YY		D1PU60J+6019YY	D1PU60J+##19YY	G, V
		ENERGY SAVER POLYON™	04, 09, 63, 73	2400	D1SW60JU0419YY	D1SW60JU0919YY	D1SW60JU7319YY	D1SW60JU6019YY	D1SW60JU##19YY	
		POLYFLEXON™ CAST	04, 09, 60, 48, 57	1800	D1RP60JK0419YY	D1RP60JK0919YY		D1RP60JK6019YY	D1RP60JK##19YY	
		POLYFLEXON™		1800				D1UA60J+6419YY		N, O
		D-POLYON		1800				D1UD60JL6419YY		
ULTRAFLEX™		2000		D1UX60JL6419YY						
CHAMPION		2400				D1CP60JN6419YY				
DURALASTOMER™	09, 60, 57	2000	D1SU60JL0419YY	D1SU60JL0919YY		D1SU60JL6019YY	D1SU60JL##19YY			



D1/R1 – DUAL WHEEL KINGPINLESS SERIES – 6, 000 LB

Wheel Diameter	Thread Width	Wheel Type	Available Bearing Options	Load Cap.	When multiple bearings choices exist, replace ## with desired bearings code.					+ Color	
					D1 Series Swivel Caster Part # To order rigid casters, change part # prefix D1 to R1.						
					Roller Bearing 4	Caged Roller Bearing 09	Tapered Bearing 73	Sealed Precision BB 48, 60, 63, T3, 65	Delrin, Bronze and Plain 11, 12, 56, 57, 88, 96, B1, B5		
6	2 X 2	SUPER ELASTOMER		2640				D1EE60JI6019YY			
		ERGOLASTOMER™	04, 09, 73, 64, 57	3400	D1HU60JI0419YY	D1HU60JI0919YY	D1HU60JU7319YY	D1HU60JI6019YY	D1HU60JI##19YY		
		SEMI-STEEL	04, 09	2400	D1SS60JS0419YY	D1SS60JS0919YY		D1SS60JS6019YY	D1SS60JS##19YY		
		HEAVY DUTY IRON	04, 09, 63	2800	D1HS60JS0419YY	D1HS60JS0919YY		D1HS60JS6019YY	D1HS60JS##19YY		
		DUCTILE	04, 09, 73, 63, B1, B5	4000	D1DS60JR0419YY	D1DS60JR0919YY	D1DS60JR7319YY	D1DS60JR6019YY	D1DS60JR##19YY		
		ENERGY SAVER DUCTILE™	04, 09, B1, B5	4000	D1CD60JR0419YY	D1CD60JR0919YY		D1CD60JR6019YY	D1CD60JR##19YY		
		FORGED STEEL	04, 09, 73, 63, B1, B5	5000	D1FS60JS0419YY	D1FS60JS0919YY	D1FS60JS7319YY	D1FS60JS6019YY	D1FS60JS##19YY		
8	2 X 2	YOKE ONLY				D1ZZ80JZ8319YY			D1ZZ80JZ8319YY		
		NEO-ENERGIZER™	04, 09, 60	1200	D1EN80JB0419YY	D1EN80JB0919YY		D1EN80JB6019YY	D1EN80JB##19YY		
		NOMADIC™	04, 09, 48, 60, 57	1400	D1NM80J+0419YY	D1NM80J+0919YY		D1NM80J+6019YY	D1NM80J+##19YY	B, I	
		RUBBER ON NYLON	04, 09, 48, 60, 57	1200	D1NR80JB0419YY	D1NR80JB0919YY		D1NR80JB6019YY	D1NR80JB##19YY		
		DURA-CUSHION™	04, 09, 63	900	D1BC80J+0419YY	D1BC80J+0919YY		D1BC80J+6019YY	D1BC80J+##19YY	X, Z	
		ECO-RUBBER	53, P3	900	D1SN80UC0419YY	D1SN80UC0919YY		D1SN80UC6019YY	D1SN80UC##19YY		
		RUBBER ON ALUMINUM	04, 09, 48, 60, 57	1200	D1RA80JB0419YY	D1RA80JB0919YY		D1RA80JB6019YY	D1RA80JB##19YY		
		MOLD-ON RUBBER	04, 09, 48, 60, 57	1200	D1RS80JB0419YY	D1RS80JB0919YY		D1RS80JB6019YY	D1RS80JB##19YY		
		SUPREME RUBBER	63, 73	1600	D1RH80JS0419YY	D1RH80JS0919YY		D1RH80JS6019YY	D1RH80JS##19YY		
		THERMO-PRO™	04, 09, 60, 63, 48, 57	1200	D1TP80J+0419YY	D1TP80J+0919YY		D1TP80J+6019YY	D1TP80J+##19YY	A, I, T, X, Y, Z	
		POLYOLEFIN	04, 09, 60, 53, P3, 48, 57, 90	1800	D1PO80J+0419YY	D1PO80J+0919YY		D1PO80J+6019YY	D1PO80J+##19YY	B, E	
		NYLON	04, 09, 60, 48, 57	2200	D1NY80JE0419YY	D1NY80JE0919YY		D1NY80JE6019YY	D1NY80JE##19YY		
		IRONMAN		4400				D1NX80JB6519YY			
		ROKHARD™	04, 09, 48, 60, 57	2200	D1HI80JB0419YY	D1HI80JB0919YY		D1HI80JB6019YY	D1HI80JB##19YY		
		BRIMSTONE®	04, 09, 60, 90	2400	D1GN80JQ0419YY	D1GN80JQ0919YY		D1GN80JQ6019YY	D1GN80JQ##19YY		
		EPOXY	04, 09, 90	2400	D1OV80JQ0419YY	D1OV80JQ0919YY		D1OV80JQ6019YY	D1OV80JQ##19YY		
		MAXROK™	04, 09, 48, 60, 57	2800	D1MA80JB0419YY	D1MA80JB0919YY		D1MA80JB6019YY	D1MA80JB##19YY		
		PHENOLIC	04, 09, 60, 57	2800	D1PH80JB0419YY	D1PH80JB0919YY		D1PH80JB6019YY	D1PH80JB##19YY		
		HIGH-TEMP PHENOLIC	04, 09, 60, 90	2200	D1HT80JQ0419YY	D1HT80JQ0919YY		D1HT80JQ6019YY	D1HT80JQ##19YY		
		POLY MAXROK™	04, 09, 48, 60, 57	2800	D1MU80J+0419YY	D1MU80J+0919YY		D1MU80J+6019YY	D1MU80J+##19YY	G, K	
		POLYON AL™	04, 09, 48, 60, 57	3000	D1PA80J+0419YY	D1PA80J+0919YY		D1PA80J+6019YY	D1PA80J+##19YY	N, R	
		DW-BLACK		1500				D1DW80JLT319YY			
		DW-RED		2200				D1DW80JRT319YY			
		DW-BLUE		3200				D1DW80JBT319YY			
		DW-GRAY		3400				D1DW80JGT319YY			
		POLY-PRO™	04, 09, 48, 60, 63, 57	1600	D1PP80J+0419YY	D1PP80J+0919YY		D1PP80J+6019YY	D1PP80J+##19YY	C, D, I, K, M, U, W	
				2000				D1PP80JP4919YY			
								D1PP80JH6319YY			
		POLYMADIC™	04, 09, 48, 60, 63, 57	2000	D1PM80J+0419YY	D1PM80J+0919YY		D1PM80J+6019YY	D1PM80J+##19YY	I, M	
		POLYON™		2800				D1PU80JV6319YY			
			04, 09, 60		D1PU80J+0419YY	D1PU80J+0919YY		D1PU80J+6019YY	D1PU80J+##19YY	G, V	
		ENERGY SAVER POLYON™	04, 09, 60	3000	D1SW80JU0419YY	D1SW80JU0919YY		D1SW80JU6019YY	D1SW80JU##19YY		
		POLYFLEXON™ CAST		2000				D1RP80JK6319YY			
		POLYFLEXON™		2000				D1UA80J+6419YY		N, O	
		D-POLYON		2000				D1UD80JL6419YY			
		ULTRAFLEX™		2400		D1UX80JQ6419YY					
		CHAMPION		3000				D1CP80JN6419YY			
		DURALASTOMER™	09, 60, 63, 57	2000	D1SU80JL0419YY	D1SU80JL0919YY		D1SU80JL6019YY	D1SU80JL##19YY		
		SUPER ELASTOMER		2500				D1EE80JI6019YY			
		ERGOLASTOMER™	04, 09, 73, 64, 57	4000	D1HU80JI0419YY	D1HU80JI0919YY	D1HU80JI7319YY	D1HU80JI6019YY	D1HU80JI##19YY		
SEMI-STEEL	04, 09	2800	D1SS80JS0419YY	D1SS80JS0919YY		D1SS80JS6019YY	D1SS80JS##19YY				
HEAVY DUTY IRON	04, 09, 63	3200	D1HS80JS0419YY	D1HS80JS0919YY		D1HS80JS6019YY	D1HS80JS##19YY				
DUCTILE	04, 09, 63, 73, B1, B5	4000	D1DS80JR0419YY	D1DS80JR0919YY	D1DS80JR7319YY	D1DS80JR6019YY	D1DS80JR##19YY				
ENERGY SAVER DUCTILE™	04, 09, B1, B5	4000	D1CD80JR0419YY	D1CD80JR0919YY		D1CD80JR6019YY	D1CD80JR##19YY				
FORGED STEEL	04, 09, 73, 63, B5, B1	5000	D1FS80JS0419YY	D1FS80JS0919YY	D1FS80JS7319YY	D1FS80JS6019YY	D1FS80JS##19YY				



**D2/R2 – DUAL WHEEL KINGPINLESS SERIES – 7,000 LB**

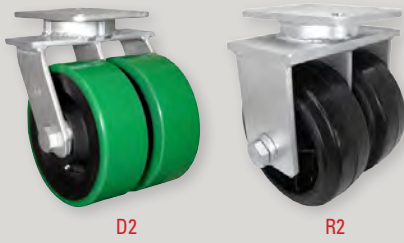

- ASTM1045 drop forged swivel head, 5/16" thick, 3" diameter precisely machined raceway of 1/2" diameter hardened ball bearings
- Legs are double welded 3/8" thick steel
- 3/4" CNC machined grade 8 axle with lock nuts
- Zinc-plated finish
- Grease fitting on raceway and axle

<b>BRAKE OPT.</b>	<b>OTHER OPTIONS</b>
<b>Face Contact Brake (F)</b>	<b>4-Position Lock (P)</b>
<b>T Handle Brake</b> 1 Side =(R) 2 Sides =(W)	<b>Toe Guard</b>
	<b>4-Position Lock Bolt-on</b> Order Separately Part # 4PSL61

FASTENING PATTERN			
Plate Code	Overall Size	Bolt Hole Pattern	Mounting Bolt Size
25	5-1/4 X 7-1/4	3-3/8 X 5-1/4 SLOTTED TO 4-1/8 X 6-1/8	1/2

WHEEL DIAMETER, OVERALL HEIGHT AND SWIVEL RADIUS		
Wheel Diameter	Overall Height	Swivel Radius
4	7	4-1/4
5	7-1/2	4-5/8
6	8	6-1/8
8	10-1/2	7-5/8
10	12-1/2	9-1/4
12	15-1/2	11-1/8

**D2/R2 – DUAL WHEEL A90 KINGPINLESS SERIES – 7,000 LB**

Wheel Dia.	Tread Width	Wheel Type	Load Capacity	Add options by replacing YY in part # with option designators.			+ Color	Overall Height	Swivel Radius
				D2 Series Swivel Caster Part # To order rigid casters, change part # prefix D1 to D2.					
				Roller Bearings 24, 27	Sealed Precision BB 65	Tapered Bearing 70, 79			
5	YOKE ONLY			D2ZZ50LZ8825YY			7-9/16	5-5/8	
	2 X 2-1/2	DUCTILE STEEL	4000	D2DS50QR2425YY					
	2 X 3	POLYON™	2800	D2PU50LG2425YY					
6	YOKE ONLY			D2ZZ60LZ8825YY			8-1/16	6-1/8	
	2 X 2-1/2	MOLD-ON RUBBER	1400	D2RS60QB2425YY					
		PHENOLIC	3200	D2PH60QB2425YY					
		POLYON™	3200	D2PU60Q+2425YY			G, V		
		ENERGY SAVER POLYON™	2400	D2SW60QU2425YY		D2SW60QU7025YY			
		ERGOLASTOMER™	4400		D2HU60QI6525YY				
		SEMI-STEEL	3600	D2SS60QS2425YY					
		DUCTILE STEEL	7000	D2DS60QR2425YY		D2DS60QR7025YY			
	ENERGY SAVER DUCTILE™	7000	D2CD60QR2425YY		D2CD60QR7025YY				
	2 X 3	MOLD-ON RUBBER	1500	D2RS60LB2425YY				6-1/8	
		SUPREME RUBBER™	1700			D2RH60LS7025YY			
		PHENOLIC	4000	D2PH60LB2425YY					
		POLYON™	4000	D2PU60L+2425YY			G, V		
		ENERGY SAVER POLYON™	4400	D2SW60LU2425YY		D2SW60LU2425YY			
	4 X 1.5	ULTRAPOLY™	6000	D2EX60LG2425YY	D2EX60LG6525YY	D2EX60LG7025YY			
DW-BLUE		7000		D2DW60LBT425YY					
2 X 3	DW-GRAY	7000		D2DW60LGT425YY					
	TITAN™ POLYMER	8000		D2PX60LO6525YY	D2PX60LO7925YY				
	IRONMAN	7000		D2NX60LB6525YY					
	SEMI-STEEL	5000	D2SS60LS2425YY						
	DUCTILE STEEL	7000	D2DS60LR2425YY	D2DS60LR6525YY	D2DS60LR7025YY				
	ENERGY SAVER DUCTILE™	7000	D2CD60LR2425YY		D2CD60LR7025YY				
	FORGED STEEL	7000	D2FS60LS2725YY		D2FS60LS7925YY				



D2/R2 – DUAL WHEEL A90 KINGPINLESS SERIES – 7,000 LB

Wheel Dia.	Tread Width	Wheel Type	Load Capacity	Add options by replacing YY in part # with option designators.			+ Color	Overall Height	Swivel Radius	
				D2 Series Swivel Caster Part # To order rigid casters, change part # prefix D1 to D2.						
				Roller Bearings 24, 27	Sealed Precision BB 65	Tapered Bearing 70, 79				
8	2 X 2-1/2	YOKE ONLY		D2ZZ80LZ8825YY				10-1/2	7-5/8	
		NEOPRENE ENERGIZER	2800	D2EN80KB2325YY	D2EN80KR8925YY					
		MOLD-ON RUBBER	1700	D2RS80QB2425YY						
		PHENOLIC	4000	D2PH80QB2425YY						
		POLYON™	4000	D2PU80Q+2425YY			G, V			
		ENERGY SAVER POLYON™	4400	D2SW80QU2425YY		D2SW80QU7025YY				
		ERGOLASTOMER™	4600		D2HU80QI6525YY					
		SEMI-STEEL	3600	D2SS80QS2425YY						
		DUCTILE	7000	D2DS80QR2425YY		D2DS80QR7025YY				
		ENERGY SAVER DUCTILE™	7000	D2CD80QR2425YY	D2CD80QR6525YY	D2CD80QR7025YY				
	2 X 3	MOLD-ON RUBBER	1800	D2RS80LB2425YY					7-5/8	
		SUPREME RUBBER™	2000			D2RH80LS7025YY				
		PHENOLIC	5000	D2PH80LB2425YY						
		HIGH-TEMP PHENOLIC	3000	D2HT80LQ2425YY						
		EPOXY	3900	D2OV80LQ2425YY						
		POLYON™	5000	D2PU80L+2425YY	D2PU80LG6525YY		G, V			
		ENERGY SAVER POLYON™	5400	D2SW80LU2425YY	D2SW80LU6525YY	D2SW80LU7025YY				
		ULTRAPOLY™	7000	D2EX80LG2425YY	D2EX80LG6525YY	D2EX80LG7025YY				
		4 X 1.5	DW-BLUE	7000		D2DW80LB2425YY				
			DW-GRAY	7000		D2DW80LGT425YY				
	2 X 3	ERGOLASTOMER™	6000		D2HU80LI6525YY					
		TITAN™ POLYMER	11000		D2PX80LO6525YY	D2PX80LO7925YY				
		IRONMAN	7000		D2NX80LB6525YY					
		SEMI-STEEL	5000	D2SS80LS2425YY						
		DUCTILE	7000	D2DS80LR2425YY	D2DS80LR6525YY	D2DS80LR7025YY				
		ENERGY SAVER DUCTILE™	7000	D2CD80LR2425YY		D2CD80LR7025YY				
	10	2 X 2-1/2	YOKE ONLY		D2ZZ10LZ8825YY				12-1/2	9-1/8
			MOLD-ON RUBBER	2000	D2RS10QB2425YY					
PHENOLIC			5000	D2PH10QB2425YY						
POLYON™			4400	D2PU10Q+2425YY			G, V			
ENERGY SAVER POLYON™			4800	D2SW10QU2425YY		D2SW10QU7025YY				
SEMI-STEEL			4000	D2SS10QS2425YY						
DUCTILE			7000	D2DS10QR2425YY						
2 X 3			MOLD-ON RUBBER	2200	D2RS10LB2425YY		D2RS10LB7025YY			9-1/4
			SUPREME RUBBER™	2600			D2RH10LS7025YY			
			PHENOLIC	5800	D2PH10LB2425YY					
		HIGH-TEMP PHENOLIC	4800	D2HT10LQ2425YY						
		EPOXY	4800	D2OV10LQ2425YY						
		POLYON™	6000	D2PU10L+2425YY	D2PU10LG6525YY		G, V			
		ENERGY SAVER POLYON™	6000	D2SW10LU2425YY		D2SW10LU7025YY				
		ULTRAPOLY™	7000	D2EX10LG2425YY	D2EX10LG6525YY	D2EX10LG7025YY				
4 X 1.5		DW-BLUE	7000		D2DW10LB2425YY					
		DW-GRAY	7000		D2DW10LGT425YY					
2 X 3		ERGOLASTOMER™	6400		D2HU10LI6525YY					
		TITAN™ POLYMER	12000		D2PX10LO6525YY	D2PX10LO7925YY				
		IRONMAN	7000		D2NX10LB6525YY					
		SEMI-STEEL	5000	D2SS10LS2425YY						
		DUCTILE	7000	D2DS10LR2425YY	D2DS10LR6525YY	D2DS10LR7025YY				
		ENERGY SAVER DUCTILE™	7000	D2CD10LR2425YY		D2CD10LR7025YY				
12		2 X 2-1/2	YOKE ONLY		D2ZZ12LZ8825YY				15-1/2	11
			MOLD-ON RUBBER	2400	D2RS12QB2425YY					
			PHENOLIC	6000	D2PH12QB2425YY					
			POLYON™	5000	D2PU12QB2425YY					
			ENERGY SAVER POLYON™	5400	D2SW12QU2425YY					
	SEMI-STEEL		4000	D2SS12QS2425YY						
	2 X 3		MOLD-ON RUBBER	2600	D2RS12LB2425YY					11-1/8
			SUPREME RUBBER™	2800			D2RH12LS7025YY			
			EPOXY	5200	D2OV12LQ2425YY					
			PHENOLIC	7000	D2PH12LB2425YY					
		POLYON™	7000	D2PU12L+2425YY	D2PU12LG6525YY		G, V			
		ENERGY SAVER POLYON™	7000	D2SW12LU2425YY		D2SW12LU7025YY				
		ULTRAPOLY™	7000	D2EX12LG2425YY	D2EX12LG6525YY	D2EX12LG7025YY				
		TITAN™ POLYMER	13000		D2PX12LO6525YY	D2PX12LO7925YY				
	2 X 3	IRONMAN	7000		D2NX12LB6525YY					
		SEMI-STEEL	5000	D2SS12LS2425YY						
		DUCTILE	7000	D2DS12LR2425YY	D2DS12LR6525YY	D2DS12LR7025YY				
		ENERGY SAVER DUCTILE™	7000	D2CD12LR2425YY		D2CD12LR7025YY				
		FORGED STEEL	7000	D2FS12LS2725YY		D2FS12LS7925YY				

## D3/R3 – DUAL WHEEL KINGPINLESS SERIES – 20,000 LB



D3

R3

- ASTM1045 steel, drop forged 1/2" thick swivel head, 4-1/2" diameter precisely machined raceway of 5/8" diameter harden steel ball bearings.
- Legs are formed from 3/8" thick steel, double welded
- 3/4" CNC machined grade 8 axle and lock nut



BRAKE OPT.

Face Contact Brake (F)

T Handle Brake  
1 Side =(R)  
2 Sides =(W)

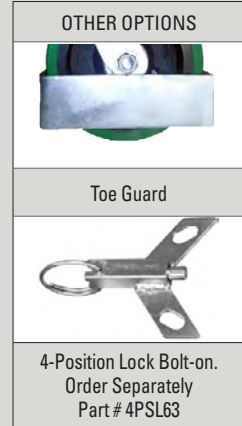

OTHER OPTIONS

Toe Guard

4-Position Lock Bolt-on.  
Order Separately  
Part # 4PSL63

### FASTENING PATTERN

Plate Code	Overall Size	Bolt Hole Pattern	Mounting Bolt Size
30	6-1/4 X 7-1/2	4-1/2 X 6 SLOTTED TO 4-1/8 X 6-1/8	1/2 TO 9/16

### D3/R3 – DUAL WHEEL KINGPINLESS SERIES – 20,000 LB

Wheel Dia.	Tread Width	Wheel Type	D3 Series Swivel Casters Part # <i>To order rigid casters change prefix D3 to R3.</i>					+ Color	Overall Height	Swivel Radius
			Roller Bearings 26, 27, 33	Weight Capacity	Tapered Bearing 70, 79	Weight Capacity	Sealed Precision 65			
6	2 X 3	YOKE ONLY	D3ZZ60LZ7130YY						8-27/32	5-13/16
		MOLD-ON RUBBER	D3RS60LB2630YY	1500						
		SUPREME RUBBER	D3RH60LS2630YY	1700	D3RH60LS7030YY	1700	D3RH60LS6530YY	1700		
		PHENOLIC	D3PH60LB2630YY	4000						
		POLYON™	D3PU60L+2630YY	4000				G, V		
		ENERGY SAVER POLYON™	D3SW60LU2630YY	4400	D3SW60LU7030YY	4400				
	4 X 1.5	ULTRAPOLY™	D3EX60LG2630YY	6000	D3EX60LG7030YY	6000	D3EX60LG6530YY	6000		
		DW-BLUE					D3DW60LBT430YY	7800		
	2 X 3	DW-GRAY					D3DW60LGT430YY	7000		
		TITAN™ POLYMER			D3PX60LO7930YY	10000	D3PX60LO6530YY	10000		
		IRONMAN					D3NX60LB6530YY	14400		
		SEMI-STEEL	D3SS60LS2630YY	5000						
		DUCTILE	D3DS60LR2630YY	12000	D3DS60LR7030YY	20000	D3DS60LR6530YY	12000		
		ENERGY SAVER DUCTILE™	D3CD60LR2630YY	12000	D3CD60LR7030YY	20000	D3CD60LR6530YY	16000		
8	2 X 3	FORGED STEEL	D3FS60LS2730YY	16000	D3FS60LS7930YY	20000				
		YOKE ONLY	D3ZZ80LZ7130YY							
		MOLD-ON RUBBER	D3RS80LB2630YY	1800						
		SUPREME RUBBER	D3RH80LS2630YY	2000	D3RH80LS7030YY	2000	D3RH80LS6530YY	2000		
		PHENOLIC	D3PH80LB2630YY	5000						
		HIGH-TEMP PHENOLIC	D3HT80LQ2630YY	3800						
	4 X 1.5	POLYON™	D3PU80L+2630YY	5000				G, V		
		ENERGY SAVER POLYON™	D3SW80LU2630YY	5400	D3SW80LU7030YY	5400				
	2 X 3	ULTRAPOLY™	D3EX80LG2630YY	7000	D3EX80LG7030YY	7000	D3EX80LG6530YY	7000		
		DW-BLUE					D3DW80LBT430YY	9000		
		DW-GRAY					D3DW80LGT430YY	8000		
		TITAN™ POLYMER			D3PX80LO7930YY	11000	D3PX80LO6530YY	11000		
		IRONMAN					D3NX80LB6530YY	14400		
		SEMI-STEEL	D3SS80LS2630YY	5000						
10	2 X 3	DUCTILE	D3DS80LR2630YY	12000	D3DS80LR7030YY	20000	D3DS80LR6530YY	12000		
		ENERGY SAVER DUCTILE™	D3CD80LR2630YY	12000	D3CD80LR7030YY	20000				
		FORGED STEEL	D3FS80LS2730YY	16000	D3FS80LS7930YY	2200				
		YOKE ONLY	D3ZZ10LZ7130YY							
		MOLD-ON RUBBER	D3RS10LB2630YY	2200						
		SUPREME RUBBER	D3RH10LS2630YY	2600	D3RH10LS7030YY	2600	D3RH10LS6530YY	2600		
	PHENOLIC	D3PH10LB2630YY	5800							



D3/R3 – DUAL WHEEL KINGPINLESS SERIES – 20,000 LB

Wheel Dia.	Tread Width	Wheel Type	D3 Series Swivel Casters Part # <i>To order rigid casters change prefix D3 to R3.</i>					+ Color	Overall Height	Swivel Radius	
			Roller Bearings 26, 27, 33	Weight Capacity	Tapered Bearing 70, 79	Weight Capacity	Sealed Precision 65				Weight Capacity
10	2 X 3	HIGH-TEMP PHENOLIC	D3HT10LQ2630YY	4800					12-13/16	9	
		POLYON™	D3PU10L+2630YY	6000				G, V			
		ENERGY SAVER POLYON™	D3SW10LU2630YY	6000	D3SW10LU7030YY	6000					
		ULTRAPOLY™	D3EX10LG2630YY	8000	D3EX10LG7030YY	8000	D3EX10LG6530YY	8000			
	4 X 1.5	DW-BLUE					D3DW10LBT430YY	10400			
		DW-GRAY					D3DW10LGT430YY	9200			
		TITAN™ POLYMER			D3PX10L07930YY	12000	D3PX10L06530YY	12000			
		IRONMAN					D3NX10LG6530YY	14400			
	2 X 3	SEMI-STEEL	D3SS10LS2630YY	5000							
		DUCTILE	D3DS10LR2630YY	14000	D3DS10LR7030YY	20000	D3DS10LR6530YY	16000			
		ENERGY SAVER DUCTILE™	D3CD10LR2630YY	14000	D3CD10LR7030YY	20000					
		FORGED STEEL	D3FS10LS2730YY	16000	D3FS10LS7930YY	20000					
12	2 X 3	YOKE ONLY	D3ZZ12LZ7130YY					15-1/2	11		
		MOLD-ON RUBBER	D3RS12LB2630YY	2600							
		SUPREME RUBBER	D3RH12LS2630YY	2800	D3RH12LS7030YY	2800	D3RH12LS6530YY				
		PHENOLIC	D3PH12LB2630YY	7000							
		POLYON™	D3PU12L+2630YY	7000						G, V	
		ENERGY SAVER POLYON™	D3SW12LU2630YY	7000	D3SW12LU7030YY	7000					
		ULTRAPOLY™	D3EX12LG2630YY	10000	D3EX12LG7030YY	10000	D3EX12LG6530YY			10000	
		TITAN™ POLYMER				D3PX12L07930YY	13000			D3PX12L06530YY	13000
		IRONMAN					D3NX12LB6530YY			14400	
		SEMI-STEEL	D3SS12LS2630YY	5000							
		DUCTILE	D3DS12LR2630YY	12000	D3DS12LR7030YY	20000	D3DS12LR6530YY			16000	
		ENERGY SAVER DUCTILE™	D3CD12LR2630YY	12000	D3CD12LR7030YY	20000					
FORGED STEEL	D3FS12LS2730YY	16000	D3FS12LS7930YY	20000	D3FS12LS6530YY	16000					
16	2 X 3	YOKE ONLY	D3ZZ16LZ7130YY					19	4-1/2		
		MOLD-ON RUBBER	D3RS16LB2630YY	3000							
		PHENOLIC	D3PH16LB2630YY	8000							
		POLYON™	D3PU16LG2630YY	8800							

Dual-Wheel



DW  
(See page 149)

IronMan™



NX  
(See page 152)

Titan™



PX  
(See page 146)

**NEW**

OUR BRAND NEW SELECTION OF WHEELS PROVIDES YOU WITH THE BEST ERGONOMICS FOR YOUR HEAVY DUTY APPLICATION



## D4/R4 – DUAL WHEEL KINGPINLESS SERIES – 40,000 LB



D4

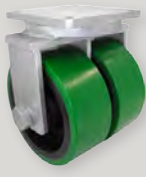

R4

- ASTM1045 steel, drop forged 5/8" thick swivel head, 7" diameter precisely machined raceway of 3/4" diameter hardened steel ball bearings.
- Legs are formed from 1/2" thick steel, double welded
- 1-1/4" grade 8 machined axle bolt
- Zinc-plated finish
- Grease fitting on raceway and axle

### BRAKE OPT.



Face Contact Brake (F)

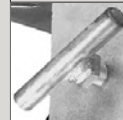

T Handle Brake  
1 Side =(R)  
2 Sides =(W)

### OTHER OPTIONS



Toe Guard



4-Position Lock Bolt-on.  
Order Separately  
Part # 4PSL65

### FASTENING PATTERN

Plate Code	Overall Size	Bolt Hole Pattern	Mounting Bolt Size
45	8-1/2 X 8-1/2	7 X 7	5/8

### D4/R4 – DUAL WHEEL KINGPINLESS SERIES – 40,000 LB

Wheel Diameter	Tread Width	Wheel Type	D4 Series Swivel Casters Part # To order rigid casters change part # D4 to R4.						Overall Height	Swivel Radius
			Roller Bearings 33	Weight Capacity	Tapered Bearing 74	Weight Capacity	Sealed Precision BB 68	Weight Capacity		
8	2 X 4	YOKE ONLY	D4ZZ80NZ7445YY						11	7-1/2
		ULTRAPOLY™	D4EX80NG3345YY	8000	D4EX80NG7445YY	8000	D4EX80NG6845YY	8000		
	4 X 2	DW-BLUE					D4DW80NBT645YY	10400		
		DW-GRAY					D4DW80NGT645YY	9400		
	2 X 4	TITAN™ POLYMER			D4PX80NO7445YY	13000	D4PX80NO6845YY	13000		
		IRONMAN™					D4NX80NB6845YY	16000		
10	2 X 4	DUCTILE	D4DS80NR3345YY	22000	D4DS80NR7445YY	34000	D4DS80NR6845YY	22000	13	9
		FORGED STEEL	D4FS80NS3345YY	22000	D4FS80NS7445YY	36000				
	4 X 2	YOKE ONLY	D4ZZ10NZ7445YY							
		MOLD-ON RUBBER	D4RS10NB3345YY	2800						
	2 X 4	ULTRAPOLY™	D4EX10NG3345YY	11000	D4EX10NG7445YY	11000	D4EX10NG6845YY	11000		
		DW-BLUE					D4DW10NBT645YY	14000		
12	2 X 3-1/2	DW-GRAY					D4DW10NGT645YY	12800		
		TITAN™ POLYMER			D4PX10NO7445YY	14000	D4PX10NO6845YY	14000		
	2 X 4	IRONMAN™					D4NX10NB6845YY	16000		
		DUCTILE	D4DS10NR3345YY	22000	D4DS10NR7445YY	34000	D4DS10NR6845YY	22000		
	2 X 3-1/2	FORGED STEEL	D4FS10NS3345YY	22000	D4FS10NS7445YY	40000				
		YOKE ONLY	D4ZZ12NZ7445YY							
12	2 X 3-1/2	SUPREME RUBBER	D4RH12MS3345YY	3000	D4RH12MS7445YY	3000			15-1/2	10-3/4
		H.T. PHENOLIC	D4HT12MB3345YY	6000						
	PHENOLIC	D4PH12MB3345YY	8000							
	2 X 4	MOLD-ON RUBBER	D4RS12NB3345YY	3000						
		ULTRAPOLY™	D4EX12NG3345YY	13000	D4EX12NG7445YY	13000	D4EX12NG6845YY	13000		
	2 X 4	TITAN™ POLYMER			D4PX12NO7445YY	16000	D4PX12NO6845YY	16000		
IRONMAN™						D4NX12NB6845YY	16000			
2 X 4	DUCTILE	D4DS12NR3345YY	22000	D4DS12NR7445YY	34000	D4DS12NR6845YY	22000			
	FORGED STEEL	D4FS12NS3345YY	22000	D4FS12NS7445YY	40000					

### Dual-Wheel

### IronMan™

### Titan™

**NEW**



DW  
(See page 149)



NX  
(See page 152)



PX  
(See page 146)

OUR BRAND NEW SELECTION OF WHEELS PROVIDES YOU WITH THE BEST ERGONOMICS FOR YOUR HEAVY DUTY APPLICATION

15/16, 7H/73/74, S7/S8/S9 – STAINLESS SERIES – 350LB



- Constructed with S304 stainless steel
- Dual ball bearing raceway
- 3/8" axle and nut
- Modular kingpin is available for any custom fastening pattern
- **Difference between 15/16 and 73/74, S7, 7H**
  - **Surface treatment:** #15 and S7 has electrolyzed shining surface, #73, 7H is mechanically polished and buffed to a smooth reflective surface
- **Raceway:** #15 and S7 does not have dust cover over the raceway; #73, 7H raceway has seal, grease fitting and dust cover
- **S7** is total-lock brake simultaneously locks both the swivel and wheel
- **7H** has a high-temp white silicon seal integrated with raceway, grease fitting on dust cover, mechanically polished and buffed to a smooth reflective surface. Seal temperature range is 390°F, intermittent 450°F

FASTENING OPTIONS

Replace \*\* in part # with desired plate or stem code.

Plate Code	Overall Size	Bolt Hole Pattern	Mounting Bolt Size
06	2-3/8 X 3-5/8	1-3/4 X 2-7/8 SLOTTED TO 3	5/16
X6	2-3/8 X 3-5/8	1-3/4 X 3 TO 2-3/16 X 2-3/4	5/16
11	3-1/8 X 4-1/8	1-3/4 X 2-15/16 TO 2-3/8 X 3-3/8	3/8
17	4 X 4-1/2	2-5/8 X 3-5/8 TO 3 X 3	3/8

Order modular stem installed with code - or uninstalled by part #				Permanently Attached Stem		
Stem Code	Size	Stem Type	Modular Stem Part #	Stem Code	Size	Stem Type
ZZ	1/2	HOLLOW KING-NO FASTENER		68	1/2 - 13 X 1-1/2	THREADED
61	3/8 - 16 X 1	THREADED	S7STS61	70	1/2 - 13 X 2-3/4	THREADED
68	1/2 - 13 X 1-1/2		S7STT68	71	.720 - .851	ROUNDED EXPANDABLE ADAPTER
S1	1/2 - 13 X 4		S7STTS1	7B	.920 - 0.980	
S2	5/8 - 11 X 4		S7STTS2	72	.852 - .927	
S6	3/4 - 10 X 2		S7STTS6	73	.928 - 1.029	
S7	3/4 - 10 X 4		S7STTS7	7A	1.020 - 1.100	
S3	3/4 - 10 X 6		S7STTS3	74	1.030 - 1.14	
S4	3/4 - 10 X 8		S7STTS4	75	1.360 - 1.425	
S5	3/4 - 10 X 10		S7STTS5	76	1.426 - 1.589	
91	7/16 X 1-3/8		GRIP RING	S7STG91	77	
95	.846 X 2-3/16	S7STG95		78	1.178 - 1.303	
57	3/4 X 2	ROUNDED W/3 CROSS DRILLED HOLES		S7STR57	S2	.852 - .927
82	1-1/8 X 2-3/16	ROUNDED GRIP RING (2 RINGS)	S7STG82	S3	.928 - 1.029	
51	3/4 X 2	SQUARE W/ 3 CROSS DRILLED HOLES	S7STS51	S6	1.426 - 1.589	
41	.865 X 2-1/4	OCTAGON W/ GRIP RING	S7STO41			
G3	7/8 X 3-1/2	SQUARE GRIP RINGS (2 RINGS)	S7STGG3			



# DURABLE SUPERIOR CASTERS®

## WHEEL DIAMETER, OVERALL HEIGHT AND SWIVEL RADIUS

Wheel Diameter	Overall Height*			Swivel Radius			
	15 Series	7H/73 Series	S7 Series	15 Series	7H/73 Series	S7 Series	S9 Series
3	4-1/8	4-3/16	4-1/4	3	2-7/8	4-3/8	3
3-1/2	4-5/8	4-5/8	4-3/4	3-1/16	3-1/4	4-3/8	3-3/16
4	5-1/8	5-1/8	5-1/4	3-1/2	3-1/2	4-3/8	3-1/2
4A	5	5		3-7/16	3-7/16		
5	6-1/8	6-3/16	6-1/4	4	4-1/16	4-3/8	4
6		7-3/8			4-1/2		

\*Reduce Overall Height 1/8" for stem casters

## BRAKE OPTIONS



Tech Lock Pedal Brake (H)

Top Lock Brake (T)

## OTHER OPTIONS

High Temp Tech Lock Brake	F
High Temp Grease	K
Zerk Axle	Z

## 15/16, 73/74, S7/S8/S9 – TOTAL LOCK STAINLESS SERIES – 350 LB

Wheel Diameter	Tread Width	Wheel Type	+ Color	Load Cap.	Bearing Type	15 Series Swivel Caster Part #	7H Series Swivel Caster Part #	73 Series Swivel Caster Part #	74 Series Rigid Caster Part #	S7 Series Total Lock Caster Part #	
						Substitute 16 for matching rigid.				*Substitute S8 for matching rigid, and S9 for matching swivel.	
3	1-1/4	YOKE ONLY					15ZZ30GZ82**YY	7HZZ30GZ82**YY	73ZZ30GZ82**YY	74ZZ30GZ82**YY	S7ZZ30GZ82**YY
		SOFT RUBBER		300	PLAIN	15SR30GB82**YY	7HSR30GB82**YY	73SR30GB82**YY	74SR30GB82**YY	S7SR30GB82**YY	
		THERMO-PRO™	T, Y	210	'PRECISION	15TP30GI44**YY	7HTP30GI44**YY	73TP30GI44**YY	74TP30GI44**YY	S7TP30GI44**YY	
						15TP30G+47**YY	7HTP30G+47**YY	73TTP30G+47**YY	74TP30G+47**YY	S7TTP30G+47**YY	
						15TP30G+90**YY	7HTP30G+90**YY	73TP30G+90**YY	74TP30G+90**YY	S7TP30G+90**YY	
						15TP30GI4S**YY	7HTP30GI4S**YY	73TP30GI4S**YY	74TP30GI4S**YY	S7TP30GI4S**YY	
		NOMADIC™		300	DELTRIN	15NM30GI5A**YY	7HNM30GI5A**YY	73NM30GI5A**YY	74NM30GI5A**YY	S7NM30GI5A**YY	
					SS PREC. BB	15NM30GI4S**YY	7HTP30GI4S**YY	73TP30GI4S**YY	74TP30GI4S**YY	S7TP30GI4S**YY	
		ELEMENT™		210	DELTRIN	15EL30GI5A**YY	7HEL30GI5A**YY	73EL30GI5A**YY	74EL30GI5A**YY	S7EL30GI5A**YY	
		POLY-PRO™	A, D, I, K, S	250	'PRECISION	15PP30G+44**YY	7HPP30G+44**YY	73PP30G+44**YY	74PP30G+44**YY	S7PP30G+44**YY	
						15PP30G+47**YY	7HPP30G+47**YY	73PP30G+47**YY	74PP30G+47**YY	S7PP30G+47**YY	
						15PP30G+90**YY	7HPP30G+90**YY	73PP30G+90**YY	74PP30G+90**YY	S7PP30G+90**YY	
						15PP30GP4S**YY	7HPP30GP4S**YY	73PP30GP4S**YY	74PP30GP4S**YY	S7PP30GP4S**YY	
		POLYMAC™		300	DELTRIN	15PM30GM5A**YY	7HPM30GM5A**YY	73PM30GM5A**YY	74PM30GM5A**YY	S7PM30GM5A**YY	
					SLEEVE	15SU30GL90**YY	7HSU30GL90**YY	73SU30GL90**YY	74SU30GL90**YY	S7SU30GL90**YY	
		DURALASTOMER™		300	SLEEVE	15SU30GL90**YY	7HSU30GL90**YY	73SU30GL90**YY	74SU30GL90**YY	S7SU30GL90**YY	
		HARD RUBBER		275	PLAIN	15HR30GB82**YY	7HHR30GB82**YY	73HR30GB82**YY	74HR30GB82**YY	S7HR30GB82**YY	
					POLYOLEFIN	B, Z	250	PLAIN	15P030G+82**YY	7HP030G+82**YY	73P030G+82**YY
		POLYOLEFIN	J, Z	300	SLEEVE	15P030G+90**YY	7HP030G+90**YY	73P030G+90**YY	74P030G+90**YY	S7P030G+90**YY	
					SS PREC. BB	15P030GZ4S**YY	7HP030GZ4S**YY	73P030GZ4S**YY	74P030GZ4S**YY	S7P030GZ4S**YY	
		H. D. POLYOLEFIN	B, E	250	PLAIN	15HP30G+82**YY	7HHP30G+82**YY	73HP30G+82**YY	74HP30G+82**YY	S7HP30G+82**YY	
					SLEEVE	15NY30GE90**YY	7HNY30GE90**YY	73NY30GE90**YY	74NY30GE90**YY	S7NY30GE90**YY	
		NYLON		300	SS PREC. BB	15NY30GE4S**YY	7HNY30GE4S**YY	73NY30GE4S**YY	74NY30GE4S**YY	S7NY30GE4S**YY	
					SS TOP HEAD	15PH30GB97**YY	7HPH30GB97**YY	73PH30GB97**YY	74PH30GB97**YY	S7PH30GB97**YY	
		PHENOLIC		300	SS TOP HEAD	15HT30GQ97**YY	7HHT30GQ97**YY	73HT30GQ97**YY	74HT30GQ97**YY	S7HT30GQ97**YY	
		H. T. PHENOLIC		200	SS TOP HEAD	15HT30GQ97**YY	7HHT30GQ97**YY	73HT30GQ97**YY	74HT30GQ97**YY	S7HT30GQ97**YY	
		BRIMSTONE®		350	SS TOP HEAD	15GN30GQ97**YY	7HGN30GQ97**YY	73GN30GQ97**YY	74GN30GQ97**YY	S7GN30GQ97**YY	
					PHENOLIC	15PH30GB90**YY	7HPH30GB90**YY	73PH30GB90**YY	74PH30GB90**YY	S7PH30GB90**YY	
3-1/2	1-1/4	YOKE ONLY					15ZZ35GZ82**YY	7HZZ35GZ82**YY	73ZZ35GZ82**YY	74ZZ35GZ82**YY	S7ZZ35GZ82**YY
		SOFT RUBBER		300	PLAIN	15SR305GB82**YY	7HSR305GB82**YY	73SR305GB82**YY	74SR305GB82**YY	S7SR305GB82**YY	
		THERMO-PRO™	T, Y	300	'PRECISION	15TP35GI44**YY	7HTP35GI44**YY	73TP35GI44**YY	74TP35GI44**YY	S7TP35GI44**YY	
						15TP35G+47**YY	7HTP35G+47**YY	73TP35G+47**YY	74TP35G+47**YY	S7TP35G+47**YY	
						15TP35TG+90**YY	7HTP35TG+90**YY	73TP35TG+90**YY	74TP35TG+90**YY	S7TP35TG+90**YY	
						15TP35GI82**YY	7HTP35GI82**YY	73TP35GI82**YY	74TP35GI82**YY	S7TP35GI82**YY	
		NOMADIC™		300	DELTRIN	15NM35GI5A**YY	7HNM35GI5A**YY	73NM35GI5A**YY	74NM35GI5A**YY	S7NM35GI5A**YY	
		ELEMENT™		220	DELTRIN	15EL35GI5A**YY	7HEL35GI5A**YY	73EL35GI5A**YY	74EL35GI5A**YY	S7EL35GI5A**YY	
		POLY-PRO™	A, D, I, K, S	300	'PRECISION	15PP35G+44**YY	7HPP35G+44**YY	73PP35G+44**YY	74PP35G+44**YY	S7PP35G+44**YY	
						15PP35G+47**YY	7HPP35G+47**YY	73PP35G+47**YY	74PP35G+47**YY	S7PP35G+47**YY	
						15PP35G+90**YY	7HPP35G+90**YY	73PP35G+90**YY	74PP35G+90**YY	S7PP35G+90**YY	
						15PP35G+2S**YY	7HPP35G+2S**YY	73PP35G+2S**YY	74PP35G+2S**YY	S7PP35G+2S**YY	
		POLYMAC™		250	DELTRIN	15PM35GM5A**YY	7HPM35GM5A**YY	73PM35GM5A**YY	74PM35GM5A**YY	S7PM35GM5A**YY	
					BALL	15US35GLA3**YY	7HUS35GLA3**YY	73US35GLA3**YY	74US35GLA3**YY	S7US35GLA3**YY	
		STAINLESS DISC		250	BALL	15US35GLA3**YY	7HUS35GLA3**YY	73US35GLA3**YY	74US35GLA3**YY	S7US35GLA3**YY	
		HARD RUBBER		300	PLAIN	15HR35GB82**YY	7HHR35GB82**YY	73HR35GB82**YY	74HR35GB82**YY	S7HR35GB82**YY	
					POLYOLEFIN	J, Z	300	PLAIN	15P035G+82**YY	7HP035G+82**YY	73P035G+82**YY
		NYLON		325	PLAIN	15NY35GE82**YY	7HNY35GE82**YY	73NY35GE82**YY	74NY35GE82**YY	S7NY35GE82**YY	
					SS PREC. BB	15NY35GE4S**YY	7HNY35GE4S**YY	73NY35GE4S**YY	74NY35GE4S**YY	S7NY35GE4S**YY	
		PHENOLIC		350	SS TOP HEAD	15PH35GB97**YY	7HPH35GB97**YY	73PH35GB97**YY	74PH35GB97**YY	S7PH35GB97**YY	

15/16, 73/74, S7/S8/S9 – TOTAL LOCK STAINLESS SERIES – 350 LB

Wheel Diameter	Tread Width	Wheel Type	+ Color	Load Cap.	Bearing Type	15 Series Swivel Caster Part #	7H Series Swivel Caster Part #	73 Series Swivel Caster Part #	74 Series Rigid Caster Part #	S7 Series Total Lock Caster Part #	
						Substitute 16 for matching rigid.				*Substitute S8 for matching rigid, and S9 for matching swivel.	
4	1-1/4	YOKE ONLY					15ZZ40GZ82**YY	7HZZ40GZ82**YY	73ZZ40GZ82**YY	74ZZ40GZ82**YY	S7ZZ40GZ82**YY
		SOFT RUBBER		350	PLAIN	15SR40GB82**YY	7HSR40GB82**YY	73SR40GB82**YY	74SR40GB82**YY	S7SR40GB82**YY	
		THERMO-PRO™	T, Y	250	'PRECISION	15TP40GI44**YY	7HTP40GI44**YY	73TP40GI44**YY	74TP40GI44**YY	S7TP40GI44**YY	
					SLEEVE	15TP40G+47**YY	7HTP40G+47**YY	73TP40G+47**YY	74TP40G+47**YY	S7TP40G+47**YY	
			SS PREC. BB		15TP40GI4S**YY	7HTP40GI4S**YY	73TP40GI4S**YY	74TP40GI4S**YY	S7TP40GI4S**YY		
			PLAIN		15TP40GI82**YY	7HTP40GI82**YY	73TP40GI82**YY	74TP40GI82**YY	S7TP40GI82**YY		
		NOMADIC™		300	DELTRIN	15NM40GI5A**YY	7HNM40GI5A**YY	73NM40GI5A**YY	74NM40GI5A**YY	S7NM40GI5A**YY	
					SS PREC. BB	15NM40GI4S**YY	7HNM40GI4S**YY	73NM40GI4S**YY	74NM40GI4S**YY	S7NM40GI4S**YY	
		ELEMENT™		240	DELTRIN	15EL40GI5A**YY	7HEL40GI5A**YY	73EL40GI5A**YY	74EL40GI5A**YY	S7EL40GI5A**YY	
		POLY-PRO™	A,D,I,S,C	300	'PRECISION	15PP40G+44**YY	7HPP40G+44**YY	73PP40G+44**YY	74PP40G+44**YY	S7PP40G+44**YY	
					SLEEVE	15PP40G+47**YY	7HPP40G+47**YY	73PP40G+47**YY	74PP40G+47**YY	S7PP40G+47**YY	
			SSPRECISION		15PP40GP4S**YY	7HPP40GP4S**YY	73PP40GP4S**YY	74PP40GP4S**YY	S7PP40GP4S**YY		
			SS BB		15PP40G+2S**YY	7HPP40G+2S**YY	73PP40G+2S**YY	74PP40G+2S**YY	S7PP40G+2S**YY		
			DELTRIN		15PP40G+55**YY	7HPP40G+55**YY	73PP40G+55**YY	74PP40G+55**YY	S7PP40G+55**YY		
		POLYMACIC™		350	DELTRIN	15PM40GM5A**YY	7HPM40GM5A**YY	73PM40GM5A**YY	74PM40GM5A**YY	S7PM40GM5A**YY	
	STAINLESS DISC		270	BALL	15US40GLA3**YY	7HUS40GLA3**YY	73US40GLA3**YY	74US40GLA3**YY	S7US40GLA3**YY		
	CONDUCTIVE		250	'PRECISION	15CN40GI44**YY	7HCN40GI44**YY	73CN40GI44**YY	74CN40GI44**YY	S7CN40GI44**YY		
	STEROLLIZER™		300	PLAIN	15BF40GC97**YY	7HBF40GC97**YY	73BF40GC97**YY	74BF40GC97**YY	S7BF40GC97**YY		
	DURALASTOMER™		350	SLEEVE	15SL40GC97**YY	7HSL40GC97**YY	73SL40GC97**YY	74SL40GC97**YY	S7SL40GC97**YY		
				HARD RUBBER	15SU40GL90**YY	7HSU40GL90**YY	73SU40GL90**YY	74SU40GL90**YY	S7SU40GL90**YY		
	POLYOLEFIN	B, Z	300	PLAIN	15P040G+82**YY	7HPO40G+82**YY	73P040G+82**YY	74P040G+82**YY	S7P040G+82**YY		
		J, Z	350	SLEEVE	15P040G+90**YY	7HPO40G+90**YY	73P040G+90**YY	74P040G+90**YY	S7P040G+90**YY		
			350	SS PREC. BB	15P040GZ4S**YY	7HPO40GZ4S**YY	73P040GZ4S**YY	74P040GZ4S**YY	S7P040GZ4S**YY		
	H. D. POLYOLEFIN	B, E	350	PLAIN	15HP40G+82**YY	7HHP40G+82**YY	73HP40G+82**YY	74HP40G+82**YY	S7HP40G+82**YY		
	NYLON		350	SLEEVE	15NY40GE90**YY	7HNY40GE90**YY	73NY40GE90**YY	74NY40GE90**YY	S7NY40GE90**YY		
				SS PREC. BB	15NY40GE4S**YY	7HNY40GE4S**YY	73NY40GE4S**YY	74NY40GE4S**YY	S7NY40GE4S**YY		
	PHENOLIC		350	SS TOP HEAD	15PH40GB97**YY	7HPH40GB97**YY	73PH40GB97**YY	74PH40GB97**YY	S7PH40GB97**YY		
	H. T. PHENOLIC		200	SS TOP HEAD	15HT40GQ97**YY	7HHT40GQ97**YY	73HT40GQ97**YY	74HT40GQ97**YY	S7HT40GQ97**YY		
	BRIMSTONE®		300	SS TOP HEAD	15GN40GQ97**YY	7HGN40GQ97**YY	73GN40GQ97**YY	74GN40GQ97**YY	S7GN40GQ97**YY		
	H. T. PHENOLIC		350	SLEEVE	15HT40HQ90**YY	7HHT40HQ90**YY	73HT40HQ90**YY	74HT40HQ90**YY	S7HT40HQ90**YY		
BRIMSTONE®				15GNY40HQ90**YY	7HGN40HQ90**YY	73GN40HQ90**YY	74GN40HQ90**YY	S7GN40HQ90**YY			
EPOXY		350	SLEEVE	15OV40HQ90**YY	7HOV40HQ90**YY	73OV40HQ90**YY	74OV40HQ90**YY	S7OV40HQ90**YY			
STEROLLIZER™		350	SS PREC. BB	15BF40HC61**YY	7HBF40HC61**YY	73BF40HC61**YY	74BF40HC61**YY	S7BF40HC61**YY			
4	1-1/4	YOKE ONLY					15ZZ4AGZ82**YY	7HZZ4AGZ82**YY	73ZZ4AGZ82**YY	74ZZ4AGZ82**YY	S7ZZ4AGZ82**YY
		SOFT RUBBER		350	PLAIN	15SR4AGB82**YY	7HSR4AGB82**YY	73SR4AGB82**YY	74SR4AGB82**YY	S7SR4AGB82**YY	
		THERMO-PRO™	T, Y	250	'PRECISION	15TP4AGI44**YY	7HTP4AGI44**YY	73TP4AGI44**YY	74TP4AGI44**YY	S7TP4AGI44**YY	
					SLEEVE	15TP4AG+47**YY	7HTP4AG+47**YY	73TP4AG+47**YY	74TP4AG+47**YY	S7TP4AG+47**YY	
			SS PREC. BB		15TP4AGI4S**YY	7HTP4AGI4S**YY	73TP4AGI4S**YY	74TP4AGI4S**YY	S7TP4AGI4S**YY		
			PLAIN		15TP4AGI82**YY	7HTP4AGI82**YY	73TP4AGI82**YY	74TP4AGI82**YY	S7TP4AGI82**YY		
		NOMADIC™		300	SS PREC. BB	15NM4AGI4S**YY	7HNM4AGI4S**YY	73NM4AGI4S**YY	74NM4AGI4S**YY	S7NM4AGI4S**YY	
					DELTRIN	15NM4AGI5A**YY	7HNM4AGI5A**YY	73NM4AGI5A**YY	74NM4AGI5A**YY	S7NM4AGI5A**YY	
		ELEMENT™		240	DELTRIN	15EL4AGI5A**YY	7HEL4AGI5A**YY	73EL4AGI5A**YY	74EL4AGI5A**YY	S7EL4AGI5A**YY	
		POLY-PRO™	A,D,I,S,C	300	'PRECISION	15PP4AG+44**YY	7HPP4AG+44**YY	73PP4AG+44**YY	74PP4AG+44**YY	S7PP4AG+44**YY	
					SLEEVE	15PP4AG+47**YY	7HPP4AG+47**YY	73PP4AG+47**YY	74PP4AG+47**YY	S7PP4AG+47**YY	
			SSPRECISION		15PP4AGP4S**YY	7HPP4AGP4S**YY	73PP4AGP4S**YY	74PP4AGP4S**YY	S7PP4AGP4S**YY		
			SS BB		15PP4AG+2S**YY	7HPP4AG+2S**YY	73PP4AG+2S**YY	74PP4AG+2S**YY	S7PP4AG+2S**YY		
			DELTRIN		15PP4AG+55**YY	7HPP4AG+55**YY	73PP4AG+55**YY	74PP4AG+55**YY	S7PP4AG+55**YY		
		POLYMACIC™		350	DELTRIN	15PM4AGM5A**YY	7HPM4AGM5A**YY	73PM4AGM5A**YY	74PM4AGM5A**YY	S7PM4AGM5A**YY	
	STAINLESS DISC		270	BALL	15US4AGLA3**YY	7HUS4AGLA3**YY	73US4AGLA3**YY	74US4AGLA3**YY	S7US4AGLA3**YY		
	CONDUCTIVE		250	'PRECISION	15CN4AGI44**YY	7HCN4AGI44**YY	73CN4AGI44**YY	74CN4AGI44**YY	S7CN4AGI44**YY		
	STEROLLIZER™		300	PLAIN	15BF4AGC97**YY	7HBF4AGC97**YY	73BF4AGC97**YY	74BF4AGC97**YY	S7BF4AGC97**YY		
	DURALASTOMER™		350	SLEEVE	15SL4AGC97**YY	7HSL4AGC97**YY	73SL4AGC97**YY	74SL4AGC97**YY	S7SL4AGC97**YY		
				HARD RUBBER	15SU4AGL90**YY	7HSU4AGL90**YY	73SU4AGL90**YY	74SU4AGL90**YY	S7SU4AGL90**YY		
	POLYOLEFIN	B, Z	300	PLAIN	15P04AG+82**YY	7HPO4AG+82**YY	73P04AG+82**YY	74P04AG+82**YY	S7P04AG+82**YY		
		J, Z	350	SLEEVE	15P04AG+90**YY	7HPO4AG+90**YY	73P04AG+90**YY	74P04AG+90**YY	S7P04AG+90**YY		
			350	SS PREC. BB	15P04AGZ4S**YY	7HPO4AGZ4S**YY	73P04AGZ4S**YY	74P04AGZ4S**YY	S7P04AGZ4S**YY		
	H. D. POLYOLEFIN	B, E	350	PLAIN	15HP4AG+82**YY	7HHP4AG+82**YY	73HP4AG+82**YY	74HP4AG+82**YY	S7HP4AG+82**YY		
	NYLON		350	SLEEVE	15NY4AGE90**YY	7HNY4AGE90**YY	73NY4AGE90**YY	74NY4AGE90**YY	S7NY4AGE90**YY		
				SS PREC. BB	15NY4AGE4S**YY	7HNY4AGE4S**YY	73NY4AGE4S**YY	74NY4AGE4S**YY	S7NY4AGE4S**YY		
	PHENOLIC		350	SS TOP HEAD	15PH4AGB97**YY	7HPH4AGB97**YY	73PH4AGB97**YY	74PH4AGB97**YY	S7PH4AGB97**YY		



# DURABLE SUPERIOR CASTERS®

15/16, 73/74, S7/S8/S9 – TOTAL LOCK STAINLESS SERIES – 350 LB

Wheel Diameter	Tread Width	Wheel Type	+ Color	Load Cap.	Bearing Type	15 Series Swivel Caster Part #	7H Series Swivel Caster Part #	73 Series Swivel Caster Part #	74 Series Rigid Caster Part #	S7 Series Total Lock Caster Part #	
						Substitute 16 for matching rigid.				*Substitute S8 for matching rigid, and S9 for matching swivel.	
4	1-1/4	H. T. PHENOLIC BRIMSTONE®		250	SS TOP HEAD	15HT4AGQ97**YY		73HT4AGQ97**YY			
				300	SS TOP HEAD	15GN4AGQ97**YY		73GN4AGQ97**YY			
	1-1/2	H. T. PHENOLIC BRIMSTONE®		350	SLEEVE	15HT4AHQ90**YY		73HT4AHQ90**YY			
				350	SLEEVE	15GN4AHQ90**YY		73GN4AHQ90**YY			
		EPOXY		350	SLEEVE	15OV4AHQ90**YY		73OV4AHQ90**YY			
		STEROLLIZER™		350	SS PREC. BB	15BF4AHC61**YY 15SL4AHC62**YY		73BF4AHC61**YY 73SL4AHC62**YY			
5	1-1/4	YOKE ONLY				15Z250GZ82**YY	7HZ250GZ82**YY	73Z250GZ82**YY	74Z250GZ82**YY	S7Z250GZ82**YY	
		NEO-ENERGIZER™		300	SS BALL B.	15EN50GB2S**YY	7HEN50GB2S**YY	73EN50GB2S**YY	74EN50GB2S**YY	S7EN50GB2S**YY	
					DELTRIN	15EN50GB55**YY	7HEN50GB55**YY	73EN50GB55**YY	74EN50GB55**YY	S7EN50GB55**YY	
		SOFT RUBBER		250	PLAIN	15SR50GB82**YY	7HSR50GB82**YY	73SR50GB82**YY	74SR50GB82**YY	S7SR50GB82**YY	
		THERMO-PRO™	T, Y	300	'PRECISION	15TP50GI44**YY	7HTP50GI44**YY	73TP50GI44**YY	74TP50GI44**YY	S7TP50GI44**YY	
						15TP50G+47**YY	7HTP50G+47**YY	73TP50G+47**YY	74TP50G+47**YY	S7TP50G+47**YY	
					SLEEVE	15TP50G+90**YY	7HTP50G+90**YY	73TP50G+90**YY	74TP50G+90**YY	S7TP50G+90**YY	
					DELTRIN	15TP50GI5A**YY	7HTP50GI5A**YY	73TP50GI5A**YY	74TP50GI5A**YY	S7TP50GI5A**YY	
					SS PREC. BB	15TP50GI4S**YY	7HTP50GI4S**YY	73TP50GI4S**YY	74TP50GI4S**YY	S7TP50GI4S**YY	
		NOMADIC™		325	DELTRIN	15NM50GI5A**YY	7HNM50GI5A**YY	73NM50GI5A**YY	74NM50GI5A**YY	S7NM50GI5A**YY	
					SS PREC. BB	15NM50GI4S**YY	7HNM50GI4S**YY	73NM50GI4S**YY	74NM50GI4S**YY	S7NM50GI4S**YY	
		ELEMENT™		250	DELTRIN	15EL50GI5A**YY	7HEL50GI5A**YY	73EL50GI5A**YY	74EL50GI5A**YY	S7EL50GI5A**YY	
		POLY-PRO™	I, A, D, S B T, Y	300	'PRECISION	15PP50G+44**YY	7HPP50G+44**YY	73PP50G+44**YY	74PP50G+44**YY	S7PP50G+44**YY	
						15PP50GZ43**YY	7HPP50GZ43**YY	73PP50GZ43**YY	74PP50GZ43**YY	S7PP50GZ43**YY	
						15PP50G+47**YY	7HPP50G+47**YY	73PP50G+47**YY	74PP50G+47**YY	S7PP50G+47**YY	
					SLEEVE	15PP50G+90**YY	7HPP50G+90**YY	73PP50G+90**YY	74PP50G+90**YY	S7PP50G+90**YY	
						SS. PREC. BB	15PP50GP4S**YY	7HPP50GP4S**YY	73PP50GP4S**YY	74PP50GP4S**YY	S7PP50GP4S**YY
						C, K, P, W		SS BB	15PP50G+2S**YY	7HPP50G+2S**YY	73PP50G+2S**YY
					DELTRIN	15PP50G+55**YY	7HPP50G+55**YY	73PP50G+55**YY	74PP50G+55**YY	S7PP50G+55**YY	
		POLYMADIC™		350	DELTRIN	15PM50GMA5**YY	15PM50GMA5**YY	73PM50GMA5**YY	74PM50GMA5**YY	S7PM50GMA5**YY	
		STAINLESS DISC		300	BALL	15US50GLA3**YY	7HUS50GLA3**YY	73HUS50GLA3**YY	74US50GLA3**YY	S7US50GLA3**YY	
		CONDUCTIVE		275	'PRECISION	15CN50GI44**YY	7HCN50GI44**YY	73CN50GI44**YY	74CN50GI44**YY	S7CN50GI44**YY	
		DURALASTOMER™		350	SLEEVE	15SU50GL90**YY	7HSU50GL90**YY	73SU50GL90**YY	74SU50GL90**YY	S7SU50GL90**YY	
		HARD RUBBER		350	PLAIN	15HR50GB82**YY	7HHR50GB82**YY	73HR50GB82**YY	74HR50GB82**YY	S7HR50GB82**YY	
		POLYOLEFIN	B, Z J, Z	350	PLAIN	15PO50G+82**YY	7HPO50G+82**YY	73PO50G+82**YY	74PO50G+82**YY	S7PO50G+82**YY	
					SLEEVE	15PO50G+90**YY	7HPO50G+90**YY	73PO50G+90**YY	74PO50G+90**YY	S7PO50G+90**YY	
					SS PREC. BB	15PO50GZ4S**YY	7HPO50GZ4S**YY	73PO50GZ4S**YY	74PO50GZ4S**YY	S7PO50GZ4S**YY	
		H. D. POLYOLEFIN	B, E	350	PLAIN	15HP50G+82**YY	7HHP50G+82**YY	73HP50G+82**YY	74HP50G+82**YY	S7HP50G+82**YY	
		NYLON		350	SLEEVE	15NY50GE90**YY	7HNY50GE90**YY	73NY50GE90**YY	74NY50GE90**YY	S7NY50GE90**YY	
					SS PREC. BB	15NY50GE4S**YY	7HNY50GE4S**YY	73NY50GE4S**YY	74NY50GE4S**YY	S7NY50GE4S**YY	
		PHENOLIC		350	SS TOP HEAD	15PH50GB97**YY	7HPH50GB97**YY	73PH50GB97**YY	74PH50GB97**YY	S7PH50GB97**YY	
		H. T. PHENOLIC		350	SS TOP HEAD	15HT50GQ97**YY	7HHT50GQ97**YY	73HT50GQ97**YY	74HT50GQ97**YY	S7HT50GQ97**YY	
BRIMSTONE®		350	SS TOP HEAD	15GN50GQ97**YY	7HGN50GQ97**YY	73GN50GQ97**YY	74GN50GQ97**YY	S7GN50GQ97**YY			
6	1-1/4	THERMO-PRO™	A, I T, Y A, I, T, Y A, K, W A, K, W T, Y T, Y	300	'PRECISION			73PP60G+44**YY	74PP60G+44**YY		
								73PP60G+47**YY	74PP60G+47**YY		
								73PP60G+4S**YY	74PP60G+4S**YY		
								73PP60G+2S**YY	74PP60G+2S**YY		
								73PP60G+55**YY	74PP60G+55**YY		
								73PP60G+90**YY	74PP60G+90**YY		
		POLY-PRO™	T, Y	300	'PRECISION			73TP60G+44**YY	74TP60G+44**YY		
								73TP60G+47**YY	74TP60G+47**YY		
								73TP60G+4S**YY	74TP60G+4S**YY		
								73TP60G+55**YY	74TP60G+55**YY		
								73TP60G+90**YY	74TP60G+90**YY		
								SS PREC. BB	73TP60G+90**YY	74TP60G+90**YY	
STAINLESS DISC		300	BALL	73US60GLA3**YY	74US60GLA3**YY						
POLYOLEFIN	J, Z Z	350	SLEEVE			73PO60G+90**YY	74PO60G+90**YY				
			SS BB			73PO60GZ2S**YY	74PO60GZ2S**YY				

\*Precision is not stainless

## 25 – STAINLESS BAKERY SERIES – 700LB



- S304 stainless
- Dual raceway
- Feature high temp wheels

25 – STAINLESS BAKERY CASTER – 700LB

Wheel Diameter	Tread Width	Wheel Type	Load Capacity	Bearings Type	25 Series Swivel Caster #	Overall Height	Swivel Radius
4	1-1/2	EPOXY	350	SLEEVE	25OV40HQ8311YY	5-1/8	3-3/8
		HI-TEMP PHENOLIC	350	SLEEVE	25HT40HQ8311YY		
				ROLLER	25HT40HQ0311YY		
		BRIMSTONE®	350	SLEEVE	25GN40HQ8311YY		
ROLLER	25GN40HQ0311YY						

## B1/B2, 31/32/TS, S5/S6 – STAINLESS STEEL SERIES – 1250LB

NEW



FASTENING SPECIFICATIONS			
Plate Code	Top Plate	Bolt Hole Pattern	Mounting Bolt
17	4X4-1/2	2-5/8 X 3-5/8 TO 3X3	3/8
19	4-1/2 X 6-1/4	2-7/16 X 4-15/16 TO 3-3/8 X 5-1/4	1/2
Size	Overall Height	Swivel Radius	
4	5-5/8	3-3/16	
5	6-1/2	4-7/8	
6	7-1/2	4-3/8	
8	9-1/2	5-3/4	

- #304 stainless steel
- Stainless grease fitting on raceway
- **Difference between series**

### RACEWAY

- **#B1, #31 and TS** have stamping formed dual raceways, with 5/8" kingbolt
- **#S5** is constructed from forged stainless steel, precisely machined single raceway, double welded legs
- **#5L** precisely machined single raceway with grease seal, double welded legs, kingpinless

### SURFACE TREATMENT

- **#B1** is mechanically polished and buffed to a smooth mirror reflective surface, while the majority of other

BRAKE OPTIONS		
Tech-Lock Pedal Brake (H)	Top Lock Brake (T)	4-Position Lock (P)

OTHER OPTIONS	
Raceway Seals (L) Rubber – up to 140° F	Raceway Seals (2) H. T. Neoprene – up to 380° F



# DURABLE SUPERIOR CASTERS®

B1/B2, 31/32/TS, S5/S6 – STAINLESS STEEL SERIES – 1250LB

Wh. Dia.	Thread Width	Wheel Type	Available Bearing Options	Color	Replace + with a desired wheel color. Replace # with desired wheel bearing.					
					Match rigid by changing suffix #31 or TS to 32.		Match rigid by changing suffix #B1 to B2.		Change suffix #S5 to S6 for rigid. Change suffix #S5 to 5L to include seal.	
					31 Series Part #	TS Series Part #	B1 Series Part #	Load Cap	S5 Swivel Series Part #	Load Cap
4	2	YOKE ONLY			31ZZ40JZ8317YY	TSZZ40JZ8TS7YY	B1ZZ40JZ8B17YY		S5ZZ40JZ83**YY	500
		NEO-ENERGIZER™	05, 6S, 57		31EN40JB##17YY	TSEN40JB##17YY	B1EN40JB##17YY	500	S5EN40JB##**YY	400
		NOMADIC™	05, 6S, 57	I, B	31NM40J+##17YY	TSNM40J+##17YY	B1NM40J+##17YY	400	S5NM40J+##**YY	400
		RUBBER ON NYLON	05, 6S, 57		31NR40JB##17YY	TSNR40JB##17YY	B1NR40JB##17YY	400	S5NR40JB##**YY	300
		THERMO-PRO™	05, 6S, 57	A, T, Y	31TP40J+##17YY	TSTP40J+##17YY	B1TP40J+##17YY	300	S5TP40J+##**YY	500
		POLYOLEFIN	05, 6S, 57	B, E	31P040J+##17YY	TSP040J+##17YY	B1P040J+##17YY	500	S5P040J+##**YY	800
		NYLON	05, 6S, 57, S5		31NY40JE##17YY	TSNY40JE##17YY	B1NY40JE##17YY	800	S5NY40JE##**YY	1400
		IRONMAN	05, 6S, 57		31NX40JB##17YY	TSNX40JB##17YY	B1NX40JB##17YY	1250	S5NX40JB##**YY	1400
		ROKHARD™	05, 6S, 57		31HI40JB##17YY	TSHI40JB##17YY	B1HI40JB##17YY	800	S5HI40JB##**YY	800
		BRIMSTONE®	05, 6S, 57		31GN40JQ##17YY	TSGN40JQ##17YY	B1GN40JQ##17YY	800	S5GN40JQ##**YY	800
		EPOXY	05, 6S, 57		31OV40JQ##17YY	TSOV40JQ##17YY	B1OV40JQ##17YY	800	S5OV40JQ##**YY	800
		MAXROK™	05, 6S, 57		31MA40JB##17YY	TSMA40JB##17YY	B1MA40JB##17YY	800	S5MA40JB##**YY	800
		PHENOLIC	05, 6S, 57		31PH40JB##17YY	TSPH40JB##17YY	B1PH40JB##17YY	800	S5PH40JB##**YY	1000
		PHENOLIC (STRAIGHT SIDED)	05, 6S, 57		31PH40TB##17YY	TSPH40TB##17YY	B1PH40TB##17YY	1000	S5PH40TB##**YY	600
		HIGH-TEMP PHENOLIC	05, 6S, 57		31HT40JQ##17YY	TSHT40JQ##17YY	B1HT40JQ##17YY	600	S5HT40JQ##**YY	700
		POLYON MAXROK™	05, 6S, 57	G, K	31MU40J+##17YY	TSMU40J+##17YY	B1MU40J+##17YY	700	S5MU40J+##**YY	500
		POLY-PRO™	05, 6S, 57	D, K, M, U, W	31PP40J+##17YY	TSP40J+##17YY	B1PP40J+##17YY	500	S5PP40J+##**YY	600
		POLYADIC™	05, 6S, 57	I, M	31PM40J+##17YY	TSPM40J+##17YY	B1PM40J+##17YY	600	S5PM40J+##**YY	750
		DURALASTOMER™	6S, 57		31SU40JL##17YY	TSSU40JL##17YY	B1SU40JL##17YY	750	S5SU40JL##**YY	1200
		SUPER ELASTOMER	6S		31EE40JI6S17YY	TSEE40JI6S17YY	B1EE40JI6S17YY	1200	S5EE40JI6S**YY	1000
ERGOLASTOMER™	05, 6S, 57		31HU40JI##17YY	TSHU40JI##17YY	B1HU40JI##17YY	1000	S5HU40JI##**YY	800		
MAXROK™	05, 6S, 57		31MV40JT##17YY	TSMV40JT##17YY	B1MV40JT##17YY	800	S5MV40JT##**YY	800		
5	2	YOKE ONLY			31ZZ50JZ8317YY	TSZZ50JZ8TS7YY	B1ZZ50JZ8B17YY		S5ZZ50JZ8S57YY	550
		NEO-ENERGIZER™	05, 6S, 57		31EN50JB##17YY	TSEN50JB##17YY	B1EN50JB##17YY	550	S5EN50JB##**YY	500
		NOMADIC™	05, 6S, 57	B, I	31NM50J+##17YY	TSNM50J+##17YY	B1NM50J+##17YY	500	S5NM50J+##**YY	450
		RUBBER ON NYLON	05, 6S, 57		31NR50JB##17YY	TSNR50JB##17YY	B1NR50JB##17YY	450	S5NR50JB##**YY	350
		THERMO-PRO™	05, 6S, 57	A, I, T, X, Y, Z	31TP50J+##17YY	TSTP50J+##17YY	B1TP50J+##17YY	350	S5TP50J+##**YY	650
		POLYOLEFIN	05, 6S, 57	B, E	31P050J+##17YY	TSP050J+##17YY	B1P050J+##17YY	650	S5P050J+##**YY	900
		NYLON	05, 6S, 57		31NY50JE##17YY	TSNY50JE##17YY	B1NY50JE##17YY	900	S5NY50JE##**YY	1400
		IRONMAN			31NX50JBS517YY	TSNX50JBS517YY	B1NX50JBS517YY	1250	S5NX50JBS5**YY	1400
		ROKHARD™	05, 6S, 57		31HI50JB##17YY	TSHI50JB##17YY	B1HI50JB##17YY	900	S5HI50JB##**YY	1000
		BRIMSTONE®	05, 6S, 57		31GN50JQ##17YY	TSGN50JQ##17YY	B1GN50JQ##17YY	1000	S5GN50JQ##**YY	1000
		EPOXY	05, 6S, 57		31OV50JQ##17YY	TSOV50JQ##17YY	B1OV50JQ##17YY	1000	S5OV50JQ##**YY	1000
		MAXROK™	05, 6S, 57		31MA50JB##17YY	TSMA50JB##17YY	B1MA50JB##17YY	1000	S5MA50JB##**YY	1000
		PHENOLIC	05, 6S, 57		31PH50JB##17YY	TSPH50JB##17YY	B1PH50JB##17YY	1000	S5PH50JB##**YY	750
		H-TEMP PHENOLIC	05, 6S, 57		31HT50JQ##17YY	TSHT50JQ##17YY	B1HT50JQ##17YY	750	S5HT50JQ##**YY	450
		STEROLLIZER™			31SL50JCB8**YY	TSSL50JCB8**YY	B1SL50JCB8**YY	450	S5SL50JCB8**YY	1000
		POLYON MAXROK™	05, 6S, 57	G, K	31MU50J+##17YY	TSMU50J+##17YY	B1MU50J+##17YY	1000	S5MU50J+##**YY	600
		POLY-PRO™	05, 6S, 57	B, C, D, K, U, M, W	31PP50J+##17YY	TSP50J+##17YY	B1PP50J+##17YY	600	S5PP50J+##**YY	700
					31PP50JPS317YY	TSP50JPST317YY	B1PP50JPSB17YY	700	S5PP50JPS3**YY	
					31PP50JHS317YY	TSP50JHST317YY	B1PP50JHSB17YY		S5PP50JHS3**YY	750
		POLYADIC™	05, 6S, 57	I, M	31PM50J+##17YY	TSPM50J+##17YY	B1PM50J+##17YY	750	S5PM50J+##**YY	900
DURALASTOMER™	05, 6S, 57		31SU50JL##17YY	TSSU50JL##17YY	B1SU50JL##17YY	900	S5SU50JL##**YY	1200		
SUPER ELASTOMER			31EE50JI6S17YY	TSEE50JI6S17YY	B1EE50JI6S17YY	1200	S5EE50JI6S**YY	1400		
ERGOLASTOMER™	05, 6S, 57		31HU50JI##17YY	TSHU50JI##17YY	B1HU50JI##17YY	1250	S5HU50JI##**YY	1400		
			31ZZ60JZ8317YY	TSZZ60JZ8TS7YY	B1ZZ60JZ8B17YY		S5ZZ60JZ8S57YY	600		
6	2	YOKE ONLY			31EN60JB##17YY	TSEN60JB##17YY	B1EN60JB##17YY	600	S5EN60JB##**YY	600
		NEO-ENERGIZER™	04, 05, 6S		31NM60JB##17YY	TSNM60JB##17YY	B1NM60JB##17YY	600	S5NM60JB##**YY	550
		NOMADIC™	05, 6S, 57		31NR60JB##17YY	TSNR60JB##17YY	B1NR60JB##17YY	550	S5NR60JB##**YY	500
		RUBBER ON NYLON	05, 6S, 57							
		THERMO-PRO™	05, 6S, 57	A, I, T, X, Y, Z	31TP60J+##17YY	TSTP60J+##17YY	B1TP60J+##17YY	500	S5TP60J+##**YY	700
		POLYOLEFIN	05, 6S, 57	B, E	31P060J+##17YY	TSP060J+##17YY	B1P060J+##17YY	700	S5P060J+##**YY	1000
		NYLON	05, 6S, 57		31NY60JE##17YY	TSNY60JE##17YY	B1NY60JE##17YY	1000	S5NY60JE##**YY	1400
		IRONMAN			31NX60JBS517YY	TSNX60JBS517YY	B1NX60JBS517YY	1250	S5NX60JBS5**YY	1400
		ROKHARD™	05, 6S, 57		31HI60JB##17YY	TSHI60JB##17YY	B1HI60JB##17YY	1000	S5HI60JB##**YY	1100
		BRIMSTONE®	05, 6S, 57		31GN60JQ##17YY	TSGN60JQ##17YY	B1GN60JQ##17YY	1100	S5GN60JQ##**YY	1100
		EPOXY	05, 6S, 57		31OV60JQ##17YY	TSOV60JQ##17YY	B1OV60JQ##17YY	1100	S5OV60JQ##**YY	1200
		MAXROK™	05, 6S, 57		31MA60JB##17YY	TSMA60JB##17YY	B1MA60JB##17YY	1200	S5MA60JB##**YY	1200
					31PH60JB##17YY	TSPH60JB##17YY	B1PH60JB##17YY	1200	S5PH60JB##**YY	1400
		PHENOLIC	05, 6S, 57		31PH60TB##17YY	TSPH60TB##17YY	B1PH60TB##17YY	1250	S5PH60TB##**YY	900



B1/B2, 31/32/TS, S5/S6 – STAINLESS STEEL SERIES – 1250LB

Wh. Dia.	Thread Width	Wheel Type	Available Bearing Options	Color	Replace + with a desired wheel color. Replace ## with desired wheel bearing.							
					Match rigid by changing suffix #31 or TS to 32.		Match rigid by changing suffix #B1 to B2.		Change suffix #S5 to S6 for rigid. Change suffix #S5 to 5L to include seal.			
					31 Series Part #	TS Series Part #	B1 Series Part #	Load Cap	S5 Swivel Series Part #	Load Cap		
8	2	HIGH-TEMP PHENOLIC	05, 6S, 57		31HT60JQ##17YY	TSHT60JQ##17YY	B1HT60JQ##17YY	900	S5HT60JQ##YY	1200		
		POLY MAXROK™	05, 6S, 57	G, K	31MU60J+##17YY	TSMU60J+##17YY	B1MU60J+##17YY	1200	S5MU60J+##YY	1200		
		POLYON-C	05, 6S, 57		31PR60JL##17YY	TSPR60JL##17YY	B1PR60JL##17YY	1200	S5PR60JL##YY	720		
		POLY-PRO™	05, 6S, 57	D, I, K, M, W, U	31PP60J+##17YY	TSP60J+##17YY	B1PP60J+##17YY	720	S5PP60J+##YY	900		
					31PP60JPS317YY	TSP60JPS317YY	B1PP60JPSB17YY	900	S5PP60JPS3YY			
					31PP60JHS317YY	TSP60JHST317YY	B1PP60JHSB17YY		S5PP60JHS3YY			
		POLYMADIC™	05, 6S, 57	I, M	31PM60J+##17YY	TSPM60J+##17YY	B1PM60J+##17YY	900	S5PM60J+##YY	1000		
		DURALASTOMER™	05, 6S, 57		31SU60JL##17YY	TSSU60JL##17YY	B1SU60JL##17YY	1000	S5SU60JL##YY	1320		
		SUPER ELASTOMER			31EE60J16S17YY	TSEE60J16S17YY	B1EE60J16S17YY	1250	S5EE60J16SYY	1400		
		ERGOLASTOMER™	05, 6S, 57		31HU60JI##17YY	TSHU60JI##17YY	B1HU60JI##17YY	1250	S5HU60JI##YY	900		
		YOKE ONLY					31ZZ80JZ8317YY	TSZZ80JZ8T317YY	B1ZZ80JZ8B17YY		S5ZZ80JZ8S57YY	600
		NEO-ENERGIZER™	05, 6S, 57		31EN80JB##17YY	TSEN80JB##17YY	B1EN80JB##17YY	600	S5EN80JB##YY	700		
		NOMADIC™	05, 6S, 57	B, I	31NM80J+##17YY	TSNM80J+##17YY	B1NM80J+##17YY	700	S5NM80J+##YY	600		
		RUBBER ON NYLON	05, 6S, 57		31NR80JB##17YY	TSNR80JB##17YY	B1NR80JB##17YY	600	S5NR80JB##YY	600		
		THERMO-PRO™	05, 6S, 57	A, I, T, X, Y, Z	31TP80J+##17YY	TSTP80J+##17YY	B1TP80J+##17YY	600	S5TP80J+##YY	900		
		POLYOLEFIN	05, 6S, 57	B, E	31PO80J+##17YY	TSP080J+##17YY	B1PO80J+##17YY	900	S5PO80J+##YY	1100		
		NYLON	05, 6S, 57		31NY80JE##17YY	TSNY80JE##17YY	B1NY80JE##17YY	1100	S5NY80JE##YY	1400		
		IRONMAN			31NX80JBS517YY	TSNX80JBS517YY	B1NX80JBS517YY	1250	S5NX80JBS5YY	1400		
		ROKHARD™	05, 6S, 57		31HI80JB##17YY	TSHI80JB##17YY	B1HI80JB##17YY	1100	S5HI80JB##YY	1200		
		BRIMSTONE®	05, 6S, 57		31GN80JQ##17YY	TSGN80JQ##17YY	B1GN80JQ##17YY	1200	S5GN80JQ##YY	1200		
		EPOXY	05, 6S, 57		31OV80JQ##17YY	TSOV80JQ##17YY	B1OV80JQ##17YY	1200	S5OV80JQ##YY	1400		
		MAXROK™	05, 6S, 57		31MA80JB##17YY	TSMA80JB##17YY	B1MA80JB##17YY	1250	S5MA80JB##YY	1400		
		PHENOLIC	05, 6S, 57		31PH80JB##17YY	TSPH80JB##17YY	B1PH80JB##17YY	1250	S5PH80JB##YY	1400		
		HIGH-TEMP PHENOLIC	05, 6S, 57		31HT80JQ##17YY	TSHT80JQ##17YY	B1HT80JQ##17YY	1100	S5HT80JQ##YY	1400		
		POLY MAXROK™	05, 6S, 57	G, K	31MU80J+##17YY	TSMU80J+##17YY	B1MU80J+##17YY	1250	S5MU80J+##YY	800		
		POLY-PRO™	05, 6S, 57	C, D, I, K, M, U, W	31PP80J+##17YY	TSP80J+##17YY	B1PP80J+##17YY	800	S5PP80J+##YY	900		
					31PP80JPS317YY	TSP80JPS317YY	B1PP80JPSB17YY	900	S5PP80JPS3YY			
					31PP80JHS317YY	TSP80JHST317YY	B1PP80JHSB17YY	1000	S5PP80JHS3YY			
POLYMADIC™	05, 6S, 57	I, M	31PM80J+##17YY	TSPM80J+##17YY	B1PM80J+##17YY	1000	S5PM80J+##YY	1000				
DURALASTOMER™	05, 6S, 57		31SU80JL##17YY	TSSU80JL##17YY	B1SU80JL##17YY	1000	S5SU80JL##YY	1440				
SUPER ELASTOMER			31EE80J16S17YY	TSEE80J16S17YY	B1EE80J16S17YY	1250	S5EE80J16SYY	1400				
ERGOLASTOMER™	05, 6S, 57		31HU80JI##17YY	TSHU80JI##17YY	B1HU80JI##17YY	1250	S5HU80JI##YY	1400				

## 4S – STAINLESS MODULAR SERIES – 1500LB

**NEW**



- S304 stainless, machined raceway
- 3/4" hexagon mounting hole to secure the modular stem

FASTENING OPTIONS			
Replace ** in part # with desired stem code.			
Stem Code	Spec.	Stem Type	Modular Part #
ZZ		3/4" HEXAGON HOLE	
T1	3/4-10 X 2-1/2	THREADED	4SSTT1
S7	3/4-10 X 4-1/2		4SSTS7
T2	1-8 X 2-1/4		4SSTST2
C7	1-8 X 4		4SSTC7

Size	Swivel Radius	Overall Height
4	3-3/16	5-7/16
5	3-7/8	6-5/16
6	4-9/16	7-5/16
8	5-15/16	9-5/16

Please contact factory for other special stems.

### 4S – STAINLESS MODULAR SERIES – 1500LB

Wheel Diameter	Thread Width	Wheel Type	Load Capacity	Available Bearing Options	+ Color	4S Series Part #			
4	2	YOKE ONLY					4SZZ40JZ83**YY		
		NEO-ENERGIZER™	500	05, 6S, 57		4SEN40JB##**YY			
		NOMADIC™	400	05, 6S, 57	I, B	4SNM40J+##**YY			
		RUBBER ON NYLON	400	05, 6S, 57		4SNR40JB##**YY			
		RUBBER ON ALUMINUM	400	05, 6S, 57		4SRA40JB##**YY			
		THERMO-PRO™	300	05, 6S, 57	A, T, Y	4STP40J+##**YY			
		POLYOLEFIN	500	05, 6S, 57	B, E	4SPO40J+##**YY			
		NYLON	800	05, 6S, 57		4SNY40JE##**YY			
		IRONMAN	1500	SS PREC. S5		4SNX40JB##**YY			
		ROKHARD™	800	05, 6S, 57		4SHI40JB##**YY			
		BRIMSTONE®	800	05, 90		4SGN40JQ##**YY			
		EPOXY	800	05, 90		4SOV40JQ##**YY			
		MAXROK™	800	05, 6S, 57		4SMA40JB##**YY			
		PHENOLIC	800	05, 6S, 57		4SPH40JB##**YY			
		PHENOLIC(STRAIGHT SIDED)	1000	05, 6S, 57, 12		4SPH40TB##**YY			
		HIGH-TEMP PHENOLIC	600	05, 90		4SHT40JQ##**YY			
		POLYON MAXROK™	700	05, 6S, 57	G, K	4SMU40J+##**YY			
		POLY AL™	800	05, 6S, 57	N, R	4SPA40J+##**YY			
		POLY-PRO™	500	05, 6S, 57	D, K, M, U, W	4SPP40J+##**YY			
		POLYMADIC™	600	05, 6S, 57	I, M	4SPM40J+##**YY			
		POLYFLEXON™	900	SS PREC. 64	N, O	4SUA40J+64**YY			
		D-POLYON	900	SS PREC. 64		4SUD40JL64**YY			
		DURALASTOMER™	750	09, 60, 57		4SSU40JL##**YY			
		SUPER ELASTOMER	1200			4SEE40J16S**YY			
		ERGOLASTOMER™	1000	05, 6S, 57		4SHU40JI##**YY			
		MAXROK™ V-GROOVE	800	05, 6S, 57		4SMV40JT##**YY			
		5	2	YOKE ONLY					4SZZ50JZ83**YY
				NEO-ENERGIZER™	550	05, 6S, 57		4SEN50JB##**YY	
NOMADIC™	500			05, 6S, 57	B, I	4SNM50J+##**YY			
RUBBER ON NYLON	450			05, 6S, 57		4SNR50JB##**YY			
RUBBER ON ALUMINUM	500			05, 6S, 57		4SRA50JB##**YY			
THERMO-PRO™	350			05, 6S, 57	A, I, T, X, Y, Z	4STP50J+##**YY			
POLYOLEFIN	650			05, 6S, 57	B, E	4SPO50J+##**YY			
NYLON	900			05, 6S, 57		4SNY50JE##**YY			
IRONMAN	1500			SS PREC. S5		4SNX50JB##**YY			
ROKHARD™	900			05, 6S, 57		4SHI50JB##**YY			
BRIMSTONE®	1000			05, 6S, 57		4SGN50JQ##**YY			
EPOXY	1000			05, 6S, 57		4SOV50JQ##**YY			
MAXROK™	1000			05, 6S, 57		4SMA50JB##**YY			
PHENOLIC	1000			05, 6S, 57		4SPH50JB##**YY			
H-TEMP PHENOLIC	750			05, 6S, 57		4SHT50JQ##**YY			
STEROLLIZER™	450					4SSL50JCB8**YY			
POLYON MAXROK™	1000			05, 6S, 57	G, K	4SMU50J+##**YY			
POLYON AL™	900			05, 6S, 57	N, R	4SPA50J+##**YY			
POLY-PRO™	600			05, 6S, 57	B, C, D, K, U, M, W	4SPP50J+##**YY			
POLYMADIC™	750			05, 6S, 57	I, M	4SPM50J+##**YY			
POLYFLEXON™	900			SS PREC. 64	N, O	4SUA50J+64**YY			
D-POLYON	900			SS PREC. 64		4SUD50JL64**YY			

4S – STAINLESS MODULAR SERIES – 1500LB

Wheel Diameter	Thread Width	Wheel Type	Load Capacity	Available Bearing Options	+ Color	4S Series Part #	
5	2	DURALASTOMER™	900	09, 60, 57		4SSU50JL##**YY	
		SUPER ELASTOMER	1200			4SEE60J16S**YY	
		ERGOLASTOMER™	1400	05, 6S, 57		4SHU50JL##**YY	
6	2	YOKE ONLY					4SZZ60JZ83**YY
		NEO-ENERGIZER™	600	05, 6S, 57		4SEN60JB##**YY	
		NOMADIC™	600	05, 6S, 57		4SNM60JB##**YY	
		RUBBER ON NYLON	550	05, 6S, 57		4SNR60JB##**YY	
		DURA-CUSHION™	350	05, 6S, 57	X, Z	4SBC60J+##**YY	
		RUBBER ON ALUMINUM	550	05, 6S, 57		4SRA60JB##**YY	
		THERMO-PRO™	500	05, 6S, 57	A, I, T, X, Y, Z	4STP60J+##**YY	
		POLYOLEFIN	700	05, 6S, 57	B, E	4SPO60J+##**YY	
		NYLON	1000	05, 6S, 57		4SNY60JE##**YY	
		IRONMAN	1500	SS PREC. S5		4SNX60JBS5**YY	
		ROKHARD™	1000	05, 6S, 57		4SHI60JB##**YY	
		BRIMSTONE®	1100	05, 6S, 57		4SGN60JQ##**YY	
		EPOXY	1100	05, 6S, 57		4SOV60JQ##**YY	
		MAXROK™	1200	05, 6S, 57		4SMA60JB##**YY	
		PHENOLIC	1200	05, 6S, 57		4SPH60JB##**YY	
		PHENOLIC ( STRAIGHT SIDED)	1250	05, 6S, 57		4SPH60TB##**YY	
		HIGH-TEMP PHENOLIC	900	05, 6S, 57		4SHT60JQ##**YY	
		POLY MAXROK™	1200	05, 6S, 57	G, K	4SMU60J+##**YY	
		POLYON AL™	1200	05, 6S, 57	N, R	4SPA60J+##**YY	
		POLY-PRO™	720	05, 6S, 57	D, I, K, M, W, U	4SPP60J+##**YY	
		POLYMADIC™	900	05, 6S, 57	I, M	4SPM60J+##**YY	
		POLYFLEXON™	900	SS PREC. 64	N, O	4SUA60J+64**YY	
		D-POLYON	900	SS PREC. 64		4SUD60JL64**YY	
		CHAMPION	1200	SS PREC. 64		4SCP60JN64**YY	
		DURALASTOMER™	1000	05, 6S, 57		4SSU60JL##**YY	
		SUPER ELASTOMER	1320			4SEE60J16S**YY	
		ERGOLASTOMER™	1700	05, 6S, 57		4SHU60JL##**YY	
8	2	YOKE ONLY					4SZZ80JZ83**YY
		NEO-ENERGIZER™	600	05, 6S, 57		4SEN80JB##**YY	
		NOMADIC™	700	05, 6S, 57	B, I	4SNM80J+##**YY	
		RUBBER ON NYLON	600	05, 6S, 57		4SNR80JB##**YY	
		DURA-CUSHION™	450	05, 6S, 57	X, Z	4SBC80J+##**YY	
		RUBBER ON ALUMINUM	600	05, 6S, 57		4SRA80JB##**YY	
		THERMO-PRO™	600	05, 6S, 57	A, I, T, X, Y, Z,	4STP80J+##**YY	
		POLYOLEFIN	900	05, 6S, 57	B, E	4SPO80J+##**YY	
		NYLON	1100	05, 6S, 57		4SNY80JE##**YY	
		IRONMAN	1500	SS PREC. S5		4SNX80JBS5**YY	
		ROKHARD™	1100	05, 6S, 57		4SHI80JB##**YY	
		BRIMSTONE®	1200	05, 6S, 57		4SGN80JQ##**YY	
		EPOXY	1200	05, 6S, 57		4SOV80JQ##**YY	
		MAXROK™	1400	05, 6S, 57		4SMA80JB##**YY	
		PHENOLIC	1250	05, 6S, 57		4SPH80JB##**YY	
		HIGH-TEMP PHENOLIC	1100	05, 6S, 57		4SHT80JQ##**YY	
		POLY MAXROK™	1250	05, 6S, 57	G, K	4SMU80J+##**YY	
		POLYON AL™	1500	05, 6S, 57	N, R	4SPA80J+##**YY	
		POLY-PRO™	800	05, 6S, 57	C, D, I, K, M, U, W	4SPP80J+##**YY	
		POLYMADIC™	1000	05, 6S, 57	I, M	4SPM80J+##**YY	
		POLYFLEXON™	1000	SS PREC. 64	N, O	4SUA80J+64**YY	
		D-POLYON	1000	SS PREC. 64		4SUD80JL64**YY	
		CHAMPION	1500	SS PREC. 64		4SCP80JN64**YY	
		DURALASTOMER™	1000	05, 6S, 57		4SSU80JL##**YY	
		SUPER ELASTOMER	1440			4SEE80J16S**YY	
		ERGOLASTOMER™	1500	05, 6S, 57		4SHU80JL##**YY	

## 67/68 – PNEUMATIC, EVER-ROLL™ AND ECO-RUBBER™ SERIES

Pneumatic  
and Foam Filled  
Pneumatic

Ever-Roll™

Eco-Rubber™



67



68

- Dual raceway with enforced legs for the best strength
- Feature different cushion wheels for different applications  
*(Please refer to wheel sections for their special characteristics)*

FASTENING SPECIFICATIONS			
Plate Code	Overall Size	Bolt Hole Pattern	Mounting Bolt Size
17	4 X 4-1/2	2-5/8 X 3-5/8 SLOTTED TO 3 X 3	3/8
19	4-1/2 X 6-1/4	2-7/16 X 4-15/16 SLOTTED TO 3-3/8 X 5-1/4	

### 67/68 – PNEUMATIC, EVER-ROLL™ AND ECO-RUBBER™ SERIES

Wheel Diameter	Tread Width	Wheel Type	Replace ** with fastening code.		Replace ** with fastening code.		Tire Color and Rim Finis	Load Capacity	Overall Height	Swivel Radius	
			Swivel Casters Part #		Rigid Casters Part #						
			Roller Bearing	Ball Bearing	Roller Bearing	Ball Bearing					
6	2	YOKE ONLY	27ZZ60JZ8317YY		28ZZ60JZ8317YY						
		PNEUMATIC-4PLY		67FP60JB6017YY		68FP60JB6017YY	BLACK ON ZINC	150	7-1/2	4-9/16	
		ECO-RUBBER		67SN60JBP317YY		68SN60JBP317YY	BALCK ON GRAY	350			
		FOAM FILLED		67FF60JB6017YY		68FF60JB6017YY	BLACK ON ZINC	200			
		EVER-ROLL™		67ER60JBP317YY		68ER60JBP317YY	BLACK ON ZINC	200			
YOKE, AXLE AND NUT		67ZZ284083**YY		68ZZ284083**YY							
7	2	ECO-RUBBER		39SN67JBP3A7YY		68SN67JBP317YY	BLACK ON GRAY	350	8	5	
8	2-1/2	YOKE ONLY	27ZZ80JZ8317YY		28ZZ80JZ8317YY				9-3/4	6-1/2	
		ECO-RUBBER		67SN80UCP317YY		68SN80UCP317YY	BLACK ON GRAY	450			
		YOKE, AXLE AND NUT		67ZZ284083**YY		68ZZ284083**YY					
	2-3/4	EVER-ROLL™		67ER80BCP3**YY		68ER80BCP3**YY	BLACK ON ZINC	250			
		PNEUMATIC-4PLY		67FP8A4C38**YY		68FP8A4C38**YY	68FP8A4C38**YY				
				67FP8A4R53**YY		68FP8A4R53**YY	68FP8A4R53**YY				GRAY ON BRASS
				67FP8A4Y53**YY		68FP8A4Y53**YY	68FP8A4Y53**YY				GRAY ON ZINC
FOAM FILLED		67FF8A4C38**YY	67FF8A4CP3**YY	68FF8A4C38**YY	68FF8A4CP3**YY	BLACK ON ZINC					
		67FF8A4R38**YY	67FF8A4R53**YY	68FF8A4R38**YY	68FF8A4R53**YY	GRAY ON BRASS					
	YOKE, AXLE AND NUT	67ZZ1AKZ8317YY		68ZZ1AKZ8317YY		GRAY ON ZINC					
10	2-3/4	ECO-RUBBER		67SN10UCP3**YY		68SN10UCP3**YY	BLACK ON GRAN	650	12-3/16	7-1/4	
	3	EVER-ROLL™		67ER10BCP3**YY		68ER10BCP3**YY	BALCK ON ZINC	280			
	3-1/2	YOKE, AXLE AND NUT		67ZZ354083**YY		68ZZ35408317YY					
		PNEUMATIC-4PLY		67FP0D4C40**YY	67FP0D4CP3**YY	68FP0D4C40**YY	68FP0D4CP3**YY	BALCK ON ZINC			
					67FP0D4Y53**YY		68FP0D4Y53**YY	BLACK ON BRASS			
		FOAM FILLED		67FF0D4C40**YY	67FF0D4CP3**YY	68FF0D4C40**YY	68FF0D4CP3**YY	BLACK ON ZINC			
			67FF0D4Y53**YY		68FF0D4Y53**YY	BLACK ON BRASS					
12		YOKE, AXLE AND NUT		67ZZ356083**YY		68ZZ356083**YY					
	3	ECO-RUBBER™		67SN12UCP3**YY		68SN12UCP3**YY	BLACK ON GRAY	850			
	3-1/2	PNEUMATIC-6PLY		67FP2D6TP3**YY		68FP2D6TP3**YY	BLACK ON WHITE	500	15-3/4	7-3/4	
FOAM FILLED			67FF2D6TP3**YY		68FF2D6TP3**YY	BLACK ON ZINC					

BRAKE OPTIONS		
Top Lock Brake (T) (8" and 10" Swivels only)	Cam-Lock Brake (C) (8", 10" and 12" Swivels) (8" and 10" Rigid)	DT Series Total-lock (6" Pneumatic and 8" Eco-Rubber)

OTHER OPTIONS	
4-Position Lock (P)	4-Position Lock Bolt-on. Order separately Part # 4PSL27

## 59, TS – ROADIE® – THE ULTIMATE CASE SERIES



59

TS

- Ultra strong, soft tread, flexible Elastomer wheel rolls easily over cords, thresholds and debris and offers a cushioned ride on uneven surfaces such as truck ramps, etc.
- Wheel features roller bearing for improved mobility; capable of taking excessive abuse
- Double ball raceways offer responsive swiveling action and durability, are sealed to protect bearings from dirt and debris; ensuring a smooth performance
- Heavy-duty caster yoke is stamped and formed from 3/16" cold rolled steel
- Optional Total-locking brake simultaneously locks both the swivel raceway and wheel
- Entire caster yoke is heat treated for a long, reliable service life
- Standard zinc-plated finish is attractive and corrosion resistant
- Features popular top plate patterns used on mobile cases
- 3/8" axle with Zerk grease fitting in axle for maintenance

Wheel Diameter	Tread Width	Load Capacity	Bearing Type	Overall Height	59 Series Swivel Caster Part #	Swivel Radius	TS Series Total-Locking Swivel Part #	Swivel Radius
4	1-3/8	500	ROLLER	5-25/64	59RD40SU49**YY	4-1/16	T5RD40SU49**YY	3-7/8

FASTENING SPECIFICATIONS			
<i>Replace ** in part # with desired plate code.</i>			
Plate Code	Overall Size	Bolt Hole Pattern	Mounting Bolt Size
10	85MM X 95MM	60MM X 80MM	8MM
17	4 X 4-1/2	2-5/8 X 3-5/8 TO 3 X 3	3/8

## 69/70 – BRASS-PLATED SERIES



69

70

Designed for the hotel and hospitality industry to handle continuous and rigorous use and provide easy-to-roll, cushioned, and quiet ride.

- Brass plated
- Quiet operation
- Shock absorbing
- Floor protection

FASTENING SPECIFICATIONS			
<i>Replace ** in part # with desired plate or stem code.</i>			
Plate Code	Overall Size	Bolt Hole Pattern or Stem Type	Mounting Bolt Size
17	4 x 4-1/2	2-5/8 X 3-5/8 SLOTTED TO 3 X 3	3/8

Wheel Diameter	Tread Width	Wheel Type	Load Capacity	Bearing Type	69 Series Swivel Caster Part #	69 Series Swivel with Wheel Brake Part #	70 Series Rigid Caster Part #	Color	Overall Height	Swivel Radius
8	2	YOKE ONLY			69ZZ80SZ8317YY				9-1/2	6
		THERMO-PRO™ (ROUND)	550	PREC. BB	69TP80JX6017YY	69TP80JX6017TY	70TP80JX6017YY	GRAY ON GRAY		
		THERMO-PRO™ (FLAT)	550	PREC. BB	69TP80JT6017YY	69TP80JT6017TY	70TP80JT6017YY	GRAY ON BEIGE		
8	2-1/2	YOKE ONLY			69ZZ80LZ8317YY				9-3/4	6-1/2
		ECO-RUBBER™	450	PREC. BB	69SN80UCP317YY	69SN80UCP317TY	70SN80UCP317YY	BLACK ON GRAY		
	2-3/4	EVER-ROLL™	250	PREC. BB	69ER80BCP317YY	69ER80BCP317TY	70ER80BCP317YY	BLACK ON ZINC		
	3	PNEUMATIC	250	BALL	69FP8A4FP317YY	69FP8A4FP317TY	70FP8A4FP317YY	BLACK ON BRASS		
	3	PNEUMATIC	250	BALL	69FP8A4RP317YY	69FP8A4RP317TY	70FP8A4RP317YY	GRAY ON BRASS		



## FH – CHARIOT™ – PREMIUM CHAIR AND EQUIPMENT SERIES



- Full heat treated raceway to enhance durability
- **Choices of:**
  - Gray and black non-marking neoprene rubber wheel
  - Black PolyFlexion™ wheel
- Wheels with precision bearings
- Brake option available
- **Available Fastening:**
  - Grip Ring Stem 7/16 x 7/8 (53)
  - 3/8" I. D. Hollow Kingpin (ZZ)

Wheel Diameter	Tread Width	Wheel Type	Load Capacity	Finishing Type	FH Series Swivel Caster Part #	Overall Height	Swivel Radius	Replace ** with desired fastening pattern.
2	13/16	GRAY RUBBER	75	BRIGHT CHROME	FH20GRC4953	2-3/4	2	
		BLACK RUBBER			FH20BRC4953			
		BLACK POLYFLEXION™			FH20BPC4953			
		GRAY RUBBER		BLACK CHROME	FH20GRB4953			
		BLACK RUBBER			FH20BRB4953			
		BLACK POLYFLEXION™			FH20BPB4953			
3	13/16	GRAY RUBBER	110	BRIGHT CHROME	FH30GRC6053	3-7/8	2-7/8	53 = 7/16 X 7/8 GRIP RING ZZ = 3/8 I.D. HOLLOW KINGPIN
		BLACK RUBBER			FH30GRC6053T*			
		BLACK POLYFLEXION™			FH30BRC60ZZ			
		GRAY RUBBER		BLACK CHROME	FH30BPC60ZZ			
		BLACK RUBBER			FH30GRB6053			
		BLACK POLYFLEXION™			FH30BRB60ZZ			
3	13/16	BLACK NEOPRENE RUBBER	110	BRIGHT CHROME	FH30BPC60ZZ	3-7/8	2-7/8	53 = 7/16 X 7/8 GRIP RING ZZ = 3/8 I.D. HOLLOW KINGPIN
					FH30GRB6053			
					FH30BRB60ZZ			
					FH30ENC60ZZT			

\*With brake

## P5/PT – POLIMED™ COMPOSITE POLYMER SERIES

**NEW**



P5



PT

- Modern attractive design, injection molded from reinforced nylon polymer
- Strong, lightweight, corrosion and chemical resistant
- Sealed precision bearings in raceway and wheel
- Non-marking
- Swivel, Total Lock and Directional Lock

FASTENING OPTION							
Replace ** in part # with desired plate or stem code.							
Plate	Overall Size	Bolt Hole Pattern			Mounting Bolt Size		
06	2-3/8 X 3-5/8	1-3/4 X 2-7/8 SLOTTED TO 3			5/16		
Order modular stems installed with stem code - or uninstalled by part #					Permanently attached stems		
Stem Code	Size	Stem Type	Modular Stem Part #	Stem Code	Size	Stem Type	
68	1/2-13/1-1/2	THREADED	S7STT68	67	1/2-13X1	THREADED	
70	1/2-13 X 2-3/4	THREADED	S7STT70				
91	7/16 X 1-3/8	GRIP RING	S7STG91				
95	.846 X 2-3/16	GRIP RING	S7STG95				
S1	1/2-13X4	THREADED	S7STTS1				
S2	5/8-11X4	THREADED	S7STTS2				
S3	3/4-10X6	THREADED	S7STTS3				

\*For more fastening, please refer to modular stem caster

Wheel Diameter	Tread Width	Wheel Type	Load Cap.	P5 Series Swivel Caster Part#	Swivel Radius	PT Series Swivel Total-Lock Caster Part #	Swivel Radius	PD Series Swivel Directional-Lock Caster Part #	Overall Height
3	1-1/4	THERMO-PRO™	250	P5TP30G144**YY	2-3/4	PTTP40G144**YY	3-3/4	PDTP30G144**YY	4-3/4
4	1-1/4		275	P5TP40G144**YY	3-7/16	PTTP40G144**YY	4-7/16	PDTP40G144**YY	5-3/4
5	1-1/4		300	P5TP50G144**YY	4	PTTP50G144**YY	4-7/16	PDTP50G144**YY	6-7/8
6	1-1/4		300	PTTP60G144**YY	4-9/16	PTTP60G144**YY	4-9/16	PDTP60G144**YY	7-11/16

Note: POLIMED™ caster is designed for perfectly smooth floor. It is not designed to take any shocks from uneven floor or ride.

## PL – POLIMA – SWIVEL AND DIRECTIONAL LOCK SERIES



- Sealed precision bearings raceway provides best swivel mobility and keeps from hair, water and small debris.
- Strong nylon construction with choice of polyurethane or soft thermo rubber
- Wheel with seal precision ball bearings for best performance and durability
- Applications: medical equipment, utility carts, and fixture

Plate Code	Overall Size		Bolt Hole Pattern		Mounting Bolt Size
B6	2-1/2 X 3-5/8		1-3/4 X 2-13/16 TO 3-1/16		5/16
P5	2-5/8 X 3		1-5/8 X 1-31/32 TO 2 X 2-13/32		5/16
Stem Code	Size	Stem Type	Stem Code	Size	Stem Type
31	5/16-18 X 1	THREADED	53	7/16 X 7/8	GRIP RING
32	3/8-16 X 3/4		91	7/16 X 1-3/8	
67	1/2-13 X 1				
M2	M12 X 1	METRIC THREADED			
M6	M16 X 25/32				

Wheel Dia.	Tread Width	Wheel Type	Load Capacity	Overall Height	PL Series Swivel Part #	PL Series Directional Lock Part #	Swivel Radius
3	2-5/16	POLYURETHANE GRAY	165	4-1/8	PL03PUBSW	PL03PUBDL	2-5/16
4	2-39/64	POLYURETHANE GRAY	220	5-3/8	PL04PUBSW	PL04PUBDL	3-1/8
		THERMOPLASTIC TPR			PL04TPBSW	PL04TPBDL	
5	3	POLYURETHANE GRAY	246	6-3/8	PL05PUBSW	PL05PUBDL	4
		THERMOPLASTIC TPR			PL05TPBSW	PL05TPBDL	

## 37/38 – SPRING LOADED MEDIUM-HEAVY DUTY SERIES



37



Springs are encapsulated in a polyurethane block for protection

- Spring encapsulated in a polyurethane block, begins compression at 400 lb to total compression at 675 lb with a spring travel of 1/2"
- Large heat treated double raceways
- 3/4" kingpin bolt
- Zinc-plated finish

WHEEL DIAMETER, OVERALL HEIGHT AND SWIVEL RADIUS		
Wheel Diameter	Overall Height	Swivel Radius
5	7-1/2	4-1/2
6	8	5
8	10	6-11/16

FASTENING PATTERN			
Plate Code	Overall Size	Bolt Hole Pattern	Mounting Bolt Size
19	4-1/2 X 6-1/4	2-7/16 X 4-15/16 SLOTTED TO 3-3/8 X 5-1/4	1/2



BRAKE OPT.

Face Contact Brake (F) 6" Casters only.



OTHER OPT.

Thread Guards (G)



# DURABLE SUPERIOR CASTERS®

## 37/38 – SPRING LOADED MEDIUM-HEAVY DUTY SERIES

Wheel Diameter	Thread Width	Wheel Type	Available Bearing Options	+ Color	Replace + with a desired wheel color. Replace ## with desired wheel bearing.		Load Capacity	
					37 Series Swivel Caster Part #	38 Series Rigid Caster Part #		
5	2	YOKE ONLY				37Z250JZ8319YY	38Z250JZ8319YY	
		ENERGIZER™	04, 09, 60'			37EN50JB##19YY	38EN50JB##19YY	550
		NOMADIC™	04, 09, 48, 60, 57		B, I	37NM50J+##19YY	38NM50J+##19YY	500
		RUBBER ON NYLON	04, 09, 48, 60, 57			37NR50JB##19YY	38NR50JB##19YY	450
		RUBBER ON ALUMINUM	04, 09, 48, 60, 57			37RA50JB##19YY	38RA50JB##19YY	500
		MOLD-ON RUBBER	04, 09, 60, 48, 57			37RS50JB##19YY	38RS50JB##19YY	400
		CUSHENDURE™				37GR50JB1919YY	38GR50JB1919YY	400
		THERMO-PRO™	04, 09, 60, 48, 63, 57		A, I, T, X, Y, Z	37TP50J+##19YY	38TP50J+##19YY	350
		STEROLLIZER™				37SL50JCB819YY	38SL50JCB819YY	450
		POLYON MAXROK™	04, 09, 48, 60, 57		G, K	37MU50J+##19YY	38MU50J+##19YY	700
		POLYON AL™	04, 09, 48, 60, 57		N, R	37PA50J+##19YY	38PA50J+##19YY	700
		POLYON - C	04, 09, 48, 60, 57, 12			37PR50JL##19YY	38PR50JL##19YY	700
		DW-BLACK				37DW50JLT319YY	38DW50JLT319YY	550
		DW-RED				37DW50JRT319YY	38DW50JRT319YY	700
		DW-BLUE				37DW50JBT319YY	38DW50JBT319YY	700
		DW-GRAY				37DW50JGT319YY	38DW50JGT319YY	700
		POLY-PRO™	04, 09, 48, 60, 63, 57		B, C, D, K, U, M, W	37PP50J+##19YY	38PP50J+##19YY	600
						37PP50JP4919YY	38PP50JP4919YY	700
		POLYMADIC™	04, 09, 48, 60, 63, 57		I, M	37PP50JH6319YY	38PP50JH6319YY	
						37PM50J+##19YY	38PM50J+##19YY	700
		POLYON™	04, 09, 60, 48		G, V	37PU50JV6319YY	38PU50JV6319YY	700
						37PU50J+##19YY	38PU50J+##19YY	700
		ENERGY SAVER POLYON™	04, 09, 60, 48			37SW50JU##19YY	38SW50JU##19YY	700
		POLYFLEXON™ CAST	04, 09, 60, 48			37RP50JK##19YY	38RP50JK##19YY	700
		POLYFLEXON™			N, O	37UA50J+6319YY	38UA50J+6319YY	700
		ULTRAFLEX™				37UX50JO6419YY	38UX50JO6419YY	600
		DURALASTOMER™	09, 60, 57			37SU50JL##19YY	38SU50JL##19YY	700
		SUPER ELASTOMER				37EE50JI6019YY	38EE50JI6019YY	700
ERGOLASTOMER™	04, 09, 73, 64, 57			37HU50JI##19YY	38HU50JI##19YY	700		
6	2	YOKE ONLY				37Z260JZ8319YY	38Z260JZ8319YY	
		ENERGIZER™	04, 09, 60			37EN60JB##19YY	38EN60JB##19YY	600
		PNEUMATIC				37FP60JB6019YY	38FP60JB6019YY	200
		FOAM FILLED				37FF60JB6019YY	38FF60JB6019YY	200
		EVER-ROLL™			B, I	37ER60J+6019YY	38ER60J+6019YY	200
		NOMADIC™	04, 09, 48, 60, 57			37NM60JB##19YY	38NM60JB##19YY	600
		RUBBER ON NYLON	04, 09, 48, 60, 57			37NR60JB##19YY	38NR60JB##19YY	550
		DURA-CUSHION™	04, 09, 63		X, Z	37BC60J+##19YY	38BC60J+##19YY	350
		ECO-RUBBER	53, P3			37SN60JC##19YY	38SN60JC##19YY	350
		RUBBER ON ALUMINUM	04, 09, 48, 60, 57			37RA60JB##19YY	38RA60JB##19YY	550
		LOW PROFILE RUBBER				37LP60JB0319YY	38LP60JB0319YY	600
		MOLD-ON RUBBER	04, 09, 48, 60, 57			37RS60JB##19YY	38RS60JB##19YY	550
		SUPREME RUBBER	63, 73			37RH60JS##19YY	38RH60JS##19YY	700
		THERMO-PRO™	04, 09, 60, 63, 48, 57		A, I, T, X, Y, Z	37TP60J+##19YY	38TP60J+##19YY	500
		POLY MAXROK™	04, 09, 60, 48, 57		G, K	37MU60J+##19YY	38MU60J+##19YY	700
		POLYON AL™	04, 09, 48, 60, 57		N, R	37PA60J+##19YY	38PA60J+##19YY	700
		POLYON-C	04, 09, 48, 60, 57, 12			37PR60JL##19YY	38PR60JL##19YY	700
		DW-BLACK				37DW60JLT319YY	38DW60JLT319YY	700
		DW-RED				37DW60JRT319YY	38DW60JRT319YY	700
		DW-BLUE				37DW60JBT319YY	38DW60JBT319YY	700
		DW-GRAY				37DW60JGT319YY	38DW60JGT319YY	700
		POLY-PRO™	04, 09, 48, 60, 57		D, I, K, M, W, U	37PP60J+##19YY	38PP60J+##19YY	700
						37PP60JP4919YY	38PP60JP4919YY	700
		POLYMADIC™	04, 09, 48, 60, 63, 57		I, M	37PP60JH6319YY	38PP60JH6319YY	
						37PM60J+##19YY	38PM60J+##19YY	700
		POLYON™	04, 09, 60		G, V	37PU60JV6319YY	38PU60JV6319YY	700
						37PU60J+##19YY	38PU60J+##19YY	700
		ENERGY SAVER POLYON™	04, 09, 63, 73			37SW60JU##19YY	38SW60JU##19YY	700
POLYFLEXON™ CAST	04, 09, 60, 48, 57			37RP60JK##19YY	38RP60JK##19YY	700		
POLYFLEXON™			N, O	37UA60J+6319YY	38UA60J+6319YY	700		
ULTRAFLEX™				37UX60JO6419YY	38UX60JO6419YY	700		
CHAMPION				37CP60JN6319YY	38CP60JN6319YY	700		
DURALASTOMER™	09, 60, 57			37SU60JL##19YY	38SU60JL##19YY	700		
SUPER ELASTOMER				37EE60JI6019YY	38EE60JI6019YY	700		
ERGOLASTOMER™	04, 09, 73, 64, 57			37HU60JI##19YY	38HU60JI##19YY	700		
8	2	YOKE ONLY				37Z280JZ8319YY	38Z280JZ8319YY	
		ENERGIZER™	04, 09, 60			37EN80JB##19YY	38EN80JB##19YY	600
		NOMADIC™	04, 09, 48, 60, 57			37NM80JB##19YY	38NM80JB##19YY	700
		RUBBER ON NYLON	04, 09, 48, 60, 57			37NR80JB##19YY	38NR80JB##19YY	600
		DURA-CUSHION™	04, 09, 63		X, Z	37BC80J+##19YY	38BC80J+##19YY	450
		ECO-RUBBER	53, P3			37SN80UC##19YY	38SN80UC##19YY	450



37/38 – SPRING LOADED MEDIUM-HEAVY DUTY SERIES

Wheel Diameter	Thread Width	Wheel Type	Available Bearing Options	+ Color	Replace + with a desired wheel color. Replace ## with desired wheel bearing.		Load Capacity
					37 Series Swivel Caster Part #	38 Series Rigid Caster Part #	
8	2	RUBBER ON ALUMINUM	04, 09, 48, 60, 57		37RA80JB##19YY	38RA80JB##19YY	600
		MOLD-ON RUBBER	04, 09, 48, 60, 57		37RS80JB##19YY	38RS80JB##19YY	600
		SUPREME RUBBER	63, 73		37RH80JS##19YY	38RH80JS##19YY	700
		THERMO-PRO™	04, 09, 60, 63, 48, 57	A, I, T, X, Y, Z	37TP80J+##19YY	38TP80J+##19YY	700
		POLY MAXROK™	04, 09, 60, 48, 57	G, K	37MU80J+##19YY	38MU80J+##19YY	700
		POLYON AL™	04, 09, 48, 60, 57	N, R	37PA80J+##19YY	38PA80J+##19YY	700
		POLYON-C	04, 09, 48, 60, 57, 12		37PR80JL##19YY	38PR80JL##19YY	700
		DW-BLACK			37DW80JLT319YY	38DW80JLT319YY	700
		DW-RED			37DW80JRT319YY	38DW80JRT319YY	700
		DW-BLUE			37DW80JBT319YY	38DW80JBT319YY	700
		DW-GRAY			37DW80JGT319YY	38DW80JGT319YY	700
		POLY-PRO™	04, 09, 48, 60, 57	D, I, K, M, W, U	37PP80J+##19YY	38PP80J+##19YY	700
					37PP80JP4919YY	38PP80JP4919YY	700
					37PP80JH6319YY	38PP80JH6319YY	700
		POLYMAC™	04, 09, 48, 60, 63, 57	I, M	37PM80J+##19YY	38PM80J+##19YY	700
		POLYON™			37PU80JV6319YY	38PU80JV6319YY	700
			04, 09, 60	G, V	37PU80J+##19YY	38PU80J+##19YY	700
		ENERGY SAVER POLYON™	04, 09, 63, 73		37SW80JU##19YY	38SW80JU##19YY	700
		POLYFLEX™ CAST	04, 09, 60, 48, 57		37RP80JK##19YY	38RP80JK##19YY	700
		POLYFLEX™		N, O	37UA80J+6319YY	38UA80J+6319YY	700
		ULTRAFLEX™			37UX80JO6419YY	38UX80JO6419YY	700
CHAMPION			37CP80JN6319YY	38CP80JN6319YY	700		
DURALASTOMER™	09, 60, 57		37SU80JL##19YY	38SU80JL##19YY	700		
SUPER ELASTOMER			37EE80JI6019YY	38EE80JI6019YY	700		
ERGOLASTOMER™	04, 09, 73, 64, 57		37HU80JI##19YY	38HU80JI##19YY	700		

\*Springs must be replaced on a regular base depends on application. Spring life is not under warranty.

G1, G2, G3 – SPRING LOADED GATE SERIES

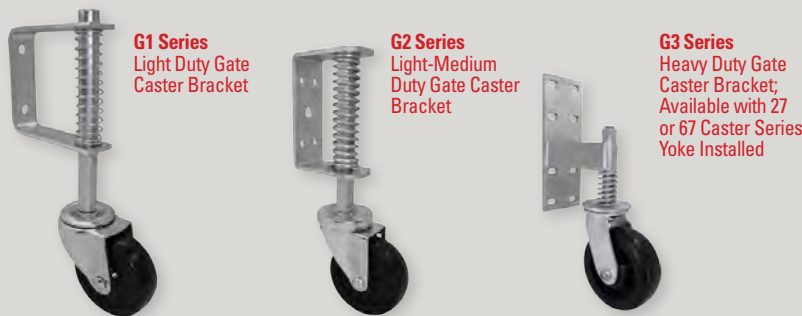

- Shock absorbing ride over uneven ground
- G1 – light duty, fits 7/16" grip ring stem casters
- G2 – medium duty, available for threaded stem and grip ring stem casters
- G3 – heavy duty

Series	Recommended Caster Series	Caster Fastening	Stem Spec.	Bracket with Spring Only	Bracket with Caster Yoke Only	Rotating Spacing	Spring Deflection		Mounting Plate Specification		
							Range (lb)	Movement	Overall Size	Bolt Size	Bolt Hole Pattern/s
G1	CASTER SERIES: #08, #09, 4" & UNDER, #21, 3-1/2" & UNDER	53, 90, 91, 97	7/16" DIA. GRIP RING	G1GRZZ		3-1/4	75 TO 100	1"	1" X 3-7/16"	5/16"	2 BOLTS, 2-1/8" APART
G2*	CASTER SERIES: #09, #21	53, 90, 91, 97, 59, 66, 67, 68, 69,	1/2"-13	G2GRZZ G2TSZZ		2-3/8	100 TO 125	1"	2" X 5-3/8"	5/16"	4 BOLTS 15/16" X 3"
G3**	CASTER SERIES: #27 6" DIA. WHEEL	37	3/4-10 X 5.5	G334ZZ	G327ZZ60JZ8337YY	5-1/4	180 TO 700	1	4" X 11"	7/16"	1-7/8" X 2-9/16" & 4-3/8" & 9-1/2"
	CASTER SERIES: #27 & #67 8" DIA. WHEEL			G380ZZ	G327ZZ80JZ8337YY	6-1/2					

\* G2 Series: recommended for use on gate with a space between the ground to bottom of the gate of 6" or more.

\*\* G3 Series: recommended for heavy duty gate, use 6" caster when space between ground to gate is 7-1/2" to 9-1/2", when space is over 9-1/2" use 8" caster.

Any caster with the appropriate stem fastening may be inserted into the G1 & G2 Series Bracket as long as the casters swivel radius is less than the stated "Rotating Spacing" (\*Please note: any caster with a swivel radius larger than the "Rotating Spacing" will not be able to swivel a full 360° and will hit the gate or door the bracket assembly is attached to; and will not operate correctly).

## 3S, 3R – SPRING LOADED MEDIUM HEAVY DUTY SERIES

**NEW**



3S



3R

- Die cast springs, total compression at 400LB with a spring travel of 7/8"
- The compression range can be adjusted by changing springs
- 2-9/16" bearing raceway is precisely machined and hardened, 3/8" hardened ball bearings
- Lower raceway thrust bearing is a tapered roller bearing, providing exceptionally smooth and easy swiveling action and counteracts radial thrust
- 3/4" integrally forged kingpin
- Zinc-plated finish
- 1/2" axle

FASTENING PATTERN			
Plate Code	Overall Size	Bolt Hole Pattern	Mounting Bolt Size
17	4 X 4-1/2	2-5/8 X 3-5/8 TO 3X3	3/8

WHEEL DIAMETER, OVERALL HEIGHT AND SWIVEL RADIUS		
Wheel Diameter	Overall Height	Swivel Radius
6	8-3/4	4-1/2
8	10	5

3S, 3R – Spring Loaded Medium Heavy Duty Series – 500LB

Wheel Diameter	Thread Width	Wheel Type	Available Bearing Options	+ Color	Replace + with a desired wheel color. Replace ## with desired wheel bearing.		Load Capacity		
					3S Series Swivel Caster Part #	3R Series Rigid Caster Part #			
5	2	YOKE ONLY				3SZZ50JZ8317YY	3RZZ50JZ8317YY		
		NEO-ENERGIZER™	04, 09, 60'			3SEN50JB##17YY	3REN50JB##17YY	550	
		NOMADIC™	04, 09, 48, 60, 57	B, I		3SNM50J+##17YY	3RNM50J+##17YY	500	
		RUBBER ON NYLON	04, 09, 48, 60, 57			3SNR50JB##17YY	3RNR50JB##17YY	450	
		RUBBER ON ALUMINUM	04, 09, 48, 60, 57			3SRA50JB##17YY	3RRA50JB##17YY	500	
		MOLD-ON RUBBER	04, 09, 60, 48, 57			3SRS50JB##17YY	3RRS50JB##17YY	400	
		CUSHENDURE™				3SGR50JB1917YY	3RGR50JB1917YY	400	
		THERMO-PRO™	04, 09, 60, 48, 63, 57	A, I, T, X, Y, Z		3STP50J+##17YY	3RTP50J+##17YY	350	
		STEROLLIZER™				3SSL50JCB817YY	3RSL50JCB817YY	450	
		POLYON MAXROK™	04, 09, 48, 60, 57	G, K		3SMU50J+##17YY	3RMU50J+##17YY	700	
		POLYON AL™	04, 09, 48, 60, 57	N, R		3SPA50J+##17YY	3RPA50J+##17YY	700	
		POLYON - C	04, 09, 48, 60, 57, 12			3SPR50JL##17YY	3RPR50JL##17YY	700	
		DW-BLACK				3SDW50JLT317YY	3RDW50JLT317YY	550	
		DW-RED				3SDW50JRT317YY	3RDW50JRT317YY	700	
		DW-BLUE				3SDW50JBT317YY	3RDW50JBT317YY	700	
		DW-GRAY				3SDW50JGT317YY	3RDW50JGT317YY	700	
				POLY-PRO™	04, 09, 48, 60, 63, 57	B, C, D, K, U, M, W	3SPP50J+##17YY	3RPP50J+##17YY	600
							3SPP50JP6317YY	3RPP50JP6317YY	700
							3SPP50JH6317YY	3RPP50JH6317YY	700
				POLYADIC™	04, 09, 48, 60, 63, 57	I, M	3SPM50J+##17YY	3RPM50J+##17YY	700
				POLYON™			3SPU50JV6317YY	3RPU50JV6317YY	700
					04, 09, 60, 48	G, V	3SPU50J+##17YY	3RPU50J+##17YY	700
				ENERGY SAVER POLYON™	04, 09, 60, 48		3SSW50JU##17YY	3RSW50JU##17YY	700
				POLYFLEXON™ CAST	04, 09, 60, 48		3SRP50JK##17YY	3RRP50JK##17YY	700
				POLYFLEXON™		N, O	3SUA50J+6317YY	3RUA50J+6317YY	700
				ULTRAFLEX™			3SUX50J06417YY	3RUX50J06417YY	600
				DURALASTOMER™	09, 60, 57		3SSU50JL##17YY	3RSU50JL##17YY	700
				SUPER ELASTOMER			3SEE50JI6017YY	3REE50JI6017YY	700
				ERGOLASTOMER™	04, 09, 73, 64, 57		3SHU50JI##17YY	3RHU50JI##17YY	700

\* Springs must be replaced on a regular base depends on application.

\* Spring life is not under warranty.

3S, 3R – Spring Loaded Medium Heavy Duty Series – 500LB

Wheel Diameter	Thread Width	Wheel Type	Available Bearing Options	+ Color	Replace + with a desired wheel color. Replace # with desired wheel bearing.		Load Capacity	
					3S Series Swivel Caster Part #	3R Series Rigid Caster Part #		
6	2	YOKE ONLY				3SZZ60JZ8317YY	3RZZ60JZ8317YY	
		NEO-ENERGIZER™	04, 09, 60			3SEEN60JB##17YY	3REN60JB##17YY	600
		PNEUMATIC				3SFP60JB6017YY	3RFP60JB6017YY	200
		FOAM FILLED				3SFF60JB6017YY	3RFF60JB6017YY	200
		EVER-ROLL™			B, I	3SER60J+6017YY	3RR60J+6017YY	200
		NOMADIC™	04, 09, 48, 60, 57			3SNM60JB##17YY	3RNM60JB##17YY	600
		RUBBER ON NYLON	04, 09, 48, 60, 57			3SNR60JB##17YY	3RNR60JB##17YY	550
		DURA-CUSHION™	04, 09, 63		X, Z	3SBC60J+##17YY	3RBC60J+##17YY	350
		ECO-RUBBER	53, P3			3SSN60JC##17YY	3RSN60JC##17YY	350
		RUBBER ON ALUMINUM	04, 09, 48, 60, 57			3SRA60JB##17YY	3RRA60JB##17YY	550
		LOW PROFILE RUBBER				3SLP60JB0317YY	3RLP60JB0317YY	600
		MOLD-ON RUBBER	04, 09, 48, 60, 57			3SRS60JB##17YY	3RRS60JB##17YY	550
		SUPREME RUBBER	63, 73			3SRH60JS##17YY	3RRH60JS##17YY	700
		THERMO-PRO™	04, 09, 60, 63, 48, 57		A, I, T, X, Y, Z	3STP60J+##17YY	3RTP60J+##17YY	500
6	2	POLY MAXROK™	04, 09, 60, 48, 57		G, K	3SMU60J+##17YY	3RMU60J+##17YY	700
		POLYON AL™	04, 09, 48, 60, 57		N, R	3SPA60J+##17YY	3RPA60J+##17YY	700
		POLYON-C	04, 09, 48, 60, 57, 12			3SPR60JL##17YY	3RPR60JL##17YY	700
		DW-BLACK				3SDW60JLT317YY	3RDW60JLT317YY	700
		DW-RED				3SDW60JRT317YY	3RDW60JRT317YY	700
		DW-BLUE				3SDW60JBT317YY	3RDW60JBT317YY	700
		DW-GRAY				3SDW60JGT317YY	3RDW60JGT317YY	700
		POLY-PRO™	04, 09, 48, 60, 57		D, I, K, M, W, U	3SPP60J+##17YY	3RPP60J+##17YY	700
						3SPP60JP6317YY	3RPP60JP6317YY	700
						3SPP60JH6317YY	3RPP60JH6317YY	700
		POLYMADIC™	04, 09, 48, 60, 63, 57		I, M	3SPM60J+##17YY	3RPM60J+##17YY	700
		POLYON™	04, 09, 60		G, V	3SPU60JV6317YY	3RPU60JV6317YY	700
		ENERGY SAVER POLYON™	04, 09, 63, 73			3SSW60JU##17YY	3RSW60JU##17YY	700
		POLYFLEXON™ CAST	04, 09, 60, 48, 57			3SRP60JK##17YY	3RRP60JK##17YY	700
		POLYFLEXON™			N, O	3SUA60J+6317YY	3RUA60J+6317YY	700
		ULTRAFLEX™				3SUX60J06417YY	3RUX60J06417YY	700
		CHAMPION				3SCP60JN6317YY	3RCP60JN6317YY	700
		DURALASTOMER™	09, 60, 57			3SSU60JL##17YY	3RSU60JL##17YY	700
		SUPER ELASTOMER				3SEE60JI6017YY	3REE60JI6017YY	700
		ERGOLASTOMER™	04, 09, 73, 64, 57			3SHU60JI##17YY	3RHU60JI##17YY	700
8	2	YOKE ONLY				3SZZ80JZ8317YY	3RZZ80JZ8317YY	
		NEO-ENERGIZER™	04, 09, 60			3SEEN80JB##17YY	3REN80JB##17YY	600
		NOMADIC™	04, 09, 48, 60, 57			3SNM80JB##17YY	3RNM80JB##17YY	600
		RUBBER ON NYLON	04, 09, 48, 60, 57			3SNR80JB##17YY	3RNR80JB##17YY	550
		DURA-CUSHION™	04, 09, 63		X, Z	3SBC80J+##17YY	3RBC80J+##17YY	350
		ECO-RUBBER	53, P3			3SSN80JC##17YY	3RSN80JC##17YY	350
		RUBBER ON ALUMINUM	04, 09, 48, 60, 57			3SRA80JB##17YY	3RRA80JB##17YY	550
		LOW PROFILE RUBBER				3SLP80JB0317YY	3RLP80JB0317YY	600
		MOLD-ON RUBBER	04, 09, 48, 60, 57			3SRS80JB##17YY	3RRS80JB##17YY	550
		SUPREME RUBBER	63, 73			3SRH80JS##17YY	3RRH80JS##17YY	700
		THERMO-PRO™	04, 09, 60, 63, 48, 57		A, I, T, X, Y, Z	3STP80J+##17YY	3RTP80J+##17YY	500
		POLY MAXROK™	04, 09, 60, 48, 57		G, K	3SMU80J+##17YY	3RMU80J+##17YY	700
		POLYON AL™	04, 09, 48, 60, 57		N, R	3SPA80J+##17YY	3RPA80J+##17YY	700
		POLYON-C	04, 09, 48, 60, 57, 12			3SPR80JL##17YY	3RPR80JL##17YY	700
		DW-BLACK				3SDW80JLT317YY	3RDW80JLT317YY	700
		DW-RED				3SDW80JRT317YY	3RDW80JRT317YY	700
		DW-BLUE				3SDW80JBT317YY	3RDW80JBT317YY	700
		DW-GRAY				3SDW80JGT317YY	3RDW80JGT317YY	700
		POLY-PRO™	04, 09, 48, 60, 57		D, I, K, M, W, U	3SPP80J+##17YY	3RPP80J+##17YY	700
						3SPP80JP6317YY	3RPP80JP6317YY	700
						3SPP80JH6317YY	3RPP80JH6317YY	700
		POLYMADIC™	04, 09, 48, 60, 63, 57		I, M	3SPM80J+##17YY	3RPM80J+##17YY	700
		POLYON™	04, 09, 60		G, V	3SPU80JV6317YY	3RPU80JV6317YY	700
		ENERGY SAVER POLYON™	04, 09, 63, 73			3SSW80JU##17YY	3RSW80JU##17YY	700
		POLYFLEXON™ CAST	04, 09, 60, 48, 57			3SRP80JK##17YY	3RRP80JK##17YY	700
		POLYFLEXON™			N, O	3SUA80J+6317YY	3RUA80J+6317YY	700
		ULTRAFLEX™				3SUX80J06417YY	3RUX80J06417YY	700
		CHAMPION				3SCP80JN6317YY	3RCP80JN6317YY	700
		DURALASTOMER™	09, 60, 57			3SSU80JL##17YY	3RSU80JL##17YY	700
		SUPER ELASTOMER				3SEE80JI8017YY	3REE80JI8017YY	700
ERGOLASTOMER™	04, 09, 73, 64, 57			3SHU80JI##17YY	3RHU80JI##17YY	700		

\* Springs must be replaced on a regular base depends on application.

\* Spring life is not under warranty..

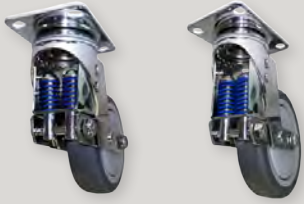

## SA/SB – LIGHT DUTY SPRING-LOADED INSTITUTIONAL SERIES

NEW

- Chrome-plated for appealing look
- Sealed swivel raceway

FASTENING PATTERN			
Plate Code	Overall Size	Bolt Hole Pattern	Mounting Bolt Size
06	2-3/4 X 3-5/8	1-3/4 X 2-7/8 TO 3	5/16

### WHEEL DIAMETER, OVERALL HEIGHT AND SWIVEL RADIUS

Wheel Dia.	Tread Width	Wheel Type	Load Capacity	SA Series Swivel Caster Part #	SB Series Rigid Caster Part #	Swivel Radius	Overall Height	Maximum Load to Full Compression	Height at Full Compression
4	1-1/4	THERMOPLASTIC TPR	250	SATP40GI4406YY	SBTP40GI4406YY	5-1/4	5-7/16	130	5
5	1-1/4		300	SATP50GI4406YY	SBTP50GI4406YY	5-3/4	6-7/16	190	5-15/16

## H5, 17, T3, 19, 75 – ADJUSTABLE HEIGHT SERIES



H5 Series Adjustable Leg

17 Series Metal Pedal Total-Lock Casters

T3 Series Plastic Pedal Total-lock Casters

19 Series Swivel (Matches O. H. of 17 Series)

75 Series Swivel Casters – Food Service Equipment Industry Standard

- Adjustable heights for various reasons, such as cleaning, uneven floor and etc.
- Fit into variety of brake designs
- Zinc-plated finish as standard. Stainless, nickel, and chrome finish are available
- Available in series #17, T3, 75

### FASTENING OPTIONS AND ADJUSTABLE RANGE

Replace " " in part # with desired plate mount or stem mounted adjustable leg code.

Fastener Code	Plate Size	Bolt Hole Pattern	Height Extension Range	Leg Length
E1	2-3/4 X 3-5/8	1-3/4 X 2-7/8 TO 3	5/8	2
E2				2-1/8
E3				3-3/4
E4				
F1				3-1/2 X 3-1/2
F2	2-1/8			
F3	3-3/4			
F4				
H5	2-5/8 X 2-5/8	1	3-1/8	
	Stem Spec	Application	Height Extension Range	Leg Length
B1	1.49 X 1-7/8	FOR 1-1/2" ID ROUND TUBING	1-1/8	1-7/8

Adjustable Stem	Wheel Dail	Height					
		17 Series		T3 Series		75 Series	
		Min.	Max.	Min.	Max.	Min.	Max.
E1	3	6-1/8	6-3/4	6	6-5/8	6	6-5/8
	4	7-1/8	7-3/4	7	7-5/8	7	7-5/8
	5	8-1/8	8-3/4	8-1/8	8-3/4	8-1/8	8-3/4
E2	3	6-1/4	6-7/8	6-1/8	6-3/4	6-1/8	6-3/4
	4	7-1/4	7-7/8	7-1/8	7-3/4	7-1/8	7-3/4
	5	8-1/4	8-7/8	8-1/4	8-7/8	8-1/4	8-7/8
E3	3	7-7/8	8-1/2	7-3/4	8-3/8	7-3/4	8-3/8
	4	8-7/8	9-1/2	8-3/4	9-3/8	8-3/4	9-3/8
	5	9-7/8	10-1/2	9-7/8	10-1/2	9-7/8	10-1/2
E4	3	7-7/8	9-3/8	7-3/4	9-1/4	7-3/4	9-1/4
	4	8-7/8	10-3/8	8-3/4	10-1/4	8-3/4	10-1/4
	5	9-7/8	11-3/8	9-7/8	11-3/8	9-7/8	11-3/8
F1	3	6-1/8	6-3/4	6	6-5/8	6	6-5/8
	4	7-1/8	7-3/4	7	7-5/8	7	7-5/8
	5	8-1/8	8-3/4	8-1/8	8-3/4	8-1/8	8-3/4
F2	3	6-1/4	6-7/8	6-1/8	6-3/4	6-1/8	6-3/4
	4	7-1/4	7-7/8	7-1/8	7-3/4	7-1/8	7-3/4
	5	8-1/4	8-7/8	8-1/4	8-7/8	8-1/4	8-7/8
F3	3	7-7/8	8-1/2	7-3/4	8-3/8	7-3/4	8-3/8
	4	8-7/8	9-1/2	8-3/4	9-3/8	8-3/4	9-3/8
	5	9-7/8	10-1/2	9-7/8	10-1/2	9-7/8	10-1/2
F4	3	7-7/8	9-3/8	7-3/4	9-1/4	7-3/4	9-1/4
	4	8-7/8	10-3/8	8-3/4	10-1/4	8-3/4	10-1/4
	5	9-7/8	11-3/8	9-7/8	11-3/8	9-7/8	11-3/8
B1	3	4-3/4	5-7/8	4-5/8	5-3/4	4-5/8	5-3/4
	4	5-3/4	6-7/8	5-5/8	6-3/4	5-5/8	6-3/4
	5	6.465	7.59	6.34	7.465	6.34	7.465

H5, 17, T3, 19, 75 – ADJUSTABLE HEIGHT SERIES

Wheel Dia	Tread Width	Wheel Type	Load Capacity	Bearings Type	T3 Series Swivel Caster Part #	Swivel Radius	17 Series Swivel Caster Part #	Swivel Radius	75 Series Swivel Caster Part #	Swivel Radius	Color	
3	1-1/4	YOKE AND AXLE/NUT				T3ZZ30GZ82**YAN	4-7/8	17ZZ30GZ82**YAN	4-3/8	75ZZ30GZ82**YAN	3	
		SOFT RUBBER	300	PLAIN	T3SR30GB82**YY	17SR30GB82**YY		75SR30GB82**YY				
				BALL	T3SR30GB42**YY	17SR30GB42**YY		75SR30GB42**YY				
		NOMADIC™	300	DELTRIN	T3NM30GI5A**YY	17NM30GI5A**YY		75NM30GI5A**YY				
				ANNULAR	T3NM30GI43**YY	17NM30GI43**YY		75NM30GI43**YY				
				PRECISION	T3TP30GI44**YY	17TP30GI44**YY		75TP30GI44**YY				
		THERMO-PRO™	210	PRECISION	T3TP30G+47**YY	17TP30G+47**YY		75TP30G+47**YY				
				SLEEVE	T3TP30G+90**YY	17TP30G+90**YY		75TP30G+90**YY		T, Y		
				BALL	T3PP30G+42**YY	17PP30G+42**YY		75PP30G+42**YY		K, W		
		POLY-PRO™	300	PRECISION	T3PP30G+44**YY	17PP30G+44**YY		75PP30G+44**YY		A, D, I, K, S		
					T3PP30G+47**YY	17PP30G+47**YY		75PP30G+47**YY				
				DELTRIN	T3PP30G+55**YY	17PP30G+55**YY		75PP30G+55**YY		K, W, P		
				SLEEVE	T3PP30G+90**YY	17PP30G+90**YY		75PP30G+90**YY		T, Y		
		POLYMADIC™	300	DELTRIN	T3PM30GM5A**YY	17PM30GM5A**YY		75PM30GM5A**YY				
				ANNULAR	T3PM30GM43**YY	17PM30GM43**YY		75PM30GM43**YY				
		DURALASTOMER™	300	SLEEVE	T3SU30GL90**YY	17SU30GL90**YY		75SU30GL90**YY				
		POLYON AL™	350	ANNULAR	T3PA30GL43**YY	17PA30GL43**YY		75PA30GL43**YY				
		HARD RUBBER	300	BALL	T3HR30GB42**YY	17HR30GB42**YY		75HR30GB42**YY				
				PLAIN	T3HR30GB82**YY	17HR30GB82**YY		75HR30GB82**YY				
		GRAYROK™	300	PLAIN	T3RK30GI82**YY	17RK30GI82**YY		75RK30GI82**YY				
	250			PLAIN	T3PO30G+82**YY	17PO30G+82**YY	75PO30G+82**YY	B, Z				
	POLYOLEFIN	300	SLEEVE	T3PO30G+90**YY	17PO30G+90**YY	75PO30G+90**YY	J, Z					
			BALL	T3PO30GZ42**YY	17PO30GZ42**YY	75PO30GZ42**YY						
	H. D. POLYOLEFIN	300	PLAIN	T3HP30G+82**YY	17HP30G+82**YY	75HP30G+82**YY						
	NYLON	300	SLEEVE	T3NY30GE90**YY	17NY30GE90**YY	75NY30GE90**YY						
			BALL	T3NY30GE47**YY	17NY30GE47**YY	75NY30GE47**YY						
	PHENOLIC	300	TOP HEAD	T3PH30GB99**YY	17PH30GB99**YY	75PH30GB99**YY						
	H. T. PHENOLIC	200	TOP HEAD	T3HT30GQ97**YY	17HT30GQ97**YY	75HT30GQ97**YY						
BRIMSTONE®	350	TOP HEAD	T3GN30GQ97**YY	17GN30GQ97**YY	75GN30GQ97**YY							
SEMI-STEEL	350	PLAIN	T3SS30GS82**YY	17SS30GS82**YY	75SS30GS82**YY							
		SLEEVE	T3SS30GS90**YY	17SS30GS90**YY	75SS30GS90**YY							
SINTERED IRON	350	PLAIN	T3SI30GS82**YY	17SI30GS82**YY	75SI30GS82**YY							
V-GROOVE	350	PLAIN	T3VG30GT82**YY	17VG30GT82**YY	75VG30GT82**YY							
		SLEEVE	T3PH30HB90**YY	17PH30HB90**YY	75PH30HB90**YY							
1-1/2	PHENOLIC	350	ROLLER	T3PH30HB03**YZ	17PH30HB03**YZ	75PH30HB03**YZ						
4	1-1/4	YOKE AND AXLE/NUT				T3ZZ40GZ82**YAN	4-7/8	17ZZ40GZ82**YAN	4-3/8	75ZZ40GZ82**YAN	3-1/2	
		SOFT RUBBER	350	PLAIN	T3SR40GB82**YY	17SR40GB82**YY		75SR40GB82**YY				
			350	BALL	T3SR40GB42**YY	17SR40GB42**YY		75SR40GB42**YY				
		RUBBER/ALU	250	ANNULAR	T3RA40GI43**YY	17RA40GI43**YY		75RA40GI43**YY				
		NOMADIC™	300	DELTRIN	T3NM40GI5A**YY	17NM40GI5A**YY		75NM40GI5A**YY				
				ANNULAR	T3NM40GI43**YY	17NM40GI43**YY		75NM40GI43**YY				
		CONDUCTIVE	250	PRECISION	T3CN40GI44**YY	17CN40GI44**YY		75CN40GI44**YY				
				PRECISION	T3TP40GI44**YY	17TP40GI44**YY		75TP40GI44**YY				
		THERMO-PRO™	250	PRECISION	T3TP40G+47**YY	17TP40G+47**YY		75TP40G+47**YY		T, Y		
				SLEEVE	T3TP40G+90**YY	17TP40G+90**YY		75TP40G+90**YY		T, Y		
				BALL	T3PP40G+42**YY	17PP40G+42**YY		75PP40G+42**YY		W, K, P		
		POLY-PRO™	350	PRECISION	T3PP40G+44**YY	17PP40G+44**YY		75PP40G+44**YY				
					T3PP40G+47**YY	17PP40G+47**YY		75PP40G+47**YY				
				DELTRIN	T3PP40G+55**YY	17PP40G+55**YY		75PP40G+55**YY				
				SLEEVE	T3PP40G+90**YY	17PP40G+90**YY		75PP40G+90**YY				
		POLYMADIC™	350	DELTRIN	T3PM40GM5A**YY	17PM40GM5A**YY		75PM40GM5A**YY				
				ANNULAR	T3PM40GM43**YY	17PM40GM43**YY		75PM40GM43**YY				
		DURALASTOMER™	350	SLEEVE	T3SU40GL90**YY	17SU40GL90**YY		75SU40GL90**YY				
		POLYON AL™	350	ANNULAR	T3PA40GL43**YY	17PA40GL43**YY		75PA40GL43**YY				
		HARD RUBBER	350	PLAIN	T3HR40GB82**YY	17HR40GB82**YY		75HR40GB82**YY				
	BALL			T3HR40GB82**YY	17HR40GB82**YY	75HR40GB82**YY						
	POLYOLEFIN	350	PLAIN	T3PO40G+82**YY	17PO40G+82**YY	75PO40G+82**YY	B, Z					
			SLEEVE	T3PO40G+90**YY	17PO40G+90**YY	75PO40G+90**YY	J, Z					
			BALL	T3PO40GZ42**YY	17PO40GZ42**YY	75PO40GZ42**YY						
	H. D. POLYOLEFIN	350	PLAIN	T3HP40G+82**YY	17HP40G+82**YY	75HP40G+82**YY	B, E					
	NYLON	350	PRECISION	T3NY40GE47**YY	17NY40GE47**YY	75NY40GE47**YY						
			SLEEVE	T3NY40GE90**YY	17NY40GE90**YY	75NY40GE90**YY						
	PHENOLIC	350	TOP HEAD	T3PH40GB99**YY	17PH40GB99**YY	75PH40GB99**YY						
	H. T. PHENOLIC	250	TOP HEAD	T3HT40GQ97**YY	17HT40GQ97**YY	75HT40GQ97**YY						
	BRIMSTONE®	350	TOP HEAD	T3GN40GQ97**YY	17GN40GQ97**YY	75GN40GQ97**YY						
	STEROLLIZER® AL	300	SLEEVE	T3BF40GC97**YZ	17BF40GC97**YZ	75BF40GC97**YZ						
	STEROLLIZER® SS	300	SLEEVE	T3SL40GC83**YY	17SL40GC83**YY	75SL40GC83**YY						
SEMI-STEEL	300	PLAIN	T3SS40GS82**YY	17SS40GS82**YY	75SS40GS82**YY							
		SLEEVE	T3SS40GS90**YY	17SS40GS90**YY	75SS40GS90**YY							
1-1/2	POLYON®	350	ROLLER	T3PU40H+03**YZ	17PU40H+03**YZ	75PU40H+03**YZ						
			POLYON AL™	350	ROLLER	T3PA40H+03**YZ	17PA40H+03**YZ	75PA40H+03**YZ				



# DURABLE SUPERIOR CASTERS®

H5, 17, T3, 19, 75 – ADJUSTABLE HEIGHT SERIES

Wheel Dia	Tread Width	Wheel Type	Load Capacity	Bearings Type	T3 Series Swivel Caster Part #	Swivel Radius	17 Series Swivel Caster Part #	Swivel Radius	75 Series Swivel Caster Part #	Swivel Radius	Color
4	1-1/2	POLYOLEFIN	350	ROLLER	T3P040HB03"YZ	4-7/8	17P040HB03"YZ	4-3/8	75P040HB03"YZ	4	
		PHENOLIC	350	SLEEVE	T3PH40HB90"YY		17PH40HB90"YY		75PH40HB90"YY		
		H. T. PHENOLIC	350	ROLLER	T3PH40HB03"YZ		17PH40HB03"YZ		75PH40HB03"YZ		
				SLEEVE	T3HT40HQ90"YY		17HT40HQ90"YY		75HT40HQ90"YY		
		BRIMSTONE®	350	ROLLER	T3HT40HQ03"YZ		17HT40HQ03"YZ		75HT40HQ03"YZ		
				SLEEVE	T3GN40HQ90"YY		17GN40HQ90"YY		75GN40HQ90"YY		
		STEROLLIZER® AL	350	SS PRECISION	T3GN40HQ03"YZ		17GN40HQ03"YZ		75GN40HQ03"YZ		
		STEROLLIZER® SS	350	SS PRECISION	T3BH40HC61"YY		17BH40HC61"YY		75BH40HC61"YY		
EPOXY	350	SLEEVE	T3SL40HC61"YY	17SL40HC61"YY	75SL40HC61"YY						
5	1-1/4	YOKE AND AXLE/NUT			T3OV40HQ03"YZ		17OV40HQ03"YZ		75OV40HQ03"YZ		
		SOFT RUBBER	350	PLAIN	T3ZZ50GZ82"YAN	4-7/8	17ZZ50GZ82"YAN	4-3/8	75ZZ50GZ82"YAN	4	
				BALL	T3SR50GB82"YY		17SR50GB82"YY		75SR50GB82"YY		
		RUBBER/ALU	275	ANNULAR	T3SR50GB42"YY		17SR50GB42"YY		75SR50GB42"YY		
				DELRIN	T3RA50GI43"YY		17RA50GI43"YY		75RA50GI43"YY		
		NOMADIC™	325	ANNULAR	T3NM50GI5A"YY		17NM50GI5A"YY		75NM50GI5A"YY		
				PRECISION	T3NM50GI43"YY		17NM50GI43"YY		75NM50GI43"YY		
		CONDUCTIVE	275	PRECISION	T3CN50GI44"YY		17CN50GI44"YY		75CN50GI44"YY		
				PRECISION	T3TP50GI44"YY		17TP50GI44"YY		75TP50GI44"YY		
		THERMO-PRO™	300	PRECISION	T3TP50G+47"YY		17TP50G+47"YY		75TP50G+47"YY		
				SLEEVE	T3TP50G+90"YY		17TP50G+90"YY		75TP50G+90"YY		
				BALL	T3PP50G+42"YY		17PP50G+42"YY		75PP50G+42"YY		
		POLY-PRO™	350	PRECISION	T3PP50G+44"YY		17PP50G+44"YY		75PP50G+44"YY		
				PRECISION	T3PP50G+47"YY		17PP50G+47"YY		75PP50G+47"YY		
				DELRIN	T3PP50G+55"YY		17PP50G+55"YY		75PP50G+55"YY		
				SLEEVE	T3PP50G+90"YY		17PP50G+90"YY		75PP50G+90"YY		
		POLYADIC™	350	DELRIN	T3PM50GM5A"YY		17PM50GM5A"YY		75PM50GM5A"YY		
				ANNULAR	T3PM50GM43"YY		17PM50GM43"YY		75PM50GM43"YY		
		DURALASTOMER™	350	SLEEVE	T3SU50GL90"YY		17SU50GL90"YY		75SU50GL90"YY		
		POLYON AL™	350	ANNULAR	T3PA50GL43"YY		17PA50GL43"YY		75PA50GL43"YY		
		HARD RUBBER	350	PLAIN	T3HR50GB82"YY		17HR50GB82"YY		75HR50GB82"YY		
				BALL	T3HR50GB42"YY		17HR50GB42"YY		75HR50GB42"YY		
		POLYOLEFIN	350	PLAIN	T3PO50G+82"YY		17PO50G+82"YY		75PO50G+82"YY		
				SLEEVE	T3PO50G+90"YY		17PO50G+90"YY		75PO50G+90"YY		
				BALL	T3PO50GZ42"YY		17PO50GZ42"YY		75PO50GZ42"YY		
		H. D. POLYOLEFIN	350	PLAIN	T3HP50G+82"YY		17HP50G+82"YY		75HP50G+82"YY		
		NYLON	350	PRECISION	T3NY50GE47"YY		17NY50GE47"YY		75NY50GE47"YY		
				SLEEVE	T3NY50GE90"YY		17NY50GE90"YY		75NY50GE90"YY		
PHENOLIC	350	TOP HEAD	T3PH50GB99"YY	17PH50GB99"YY	75PH50GB99"YY						
H. T. PHENOLIC	300	TOP HEAD	T3HT50GQ97"YY	17HT50GQ97"YY	75HT50GQ97"YY						
BRIMSTONE®	350	TOP HEAD	T3GN50GQ97"YY	17GN50GQ97"YY	75GN50GQ97"YY						
SEMI-STEEL	350	PLAIN	T3SS50GS82"YY	17SS50GS82"YY	75SS50GS82"YY						
		SLEEVE	T3SS50GS90"YY	17SS50GS90"YY	75SS50GS90"YY						

## A3, H3, O3 – INVERTED AIRCRAFT LOADING SERIES



A3HR30GB41DPGL



H3NY30GB41DPGL



O3PO31B62DPGL

- Diamond plate
- Raceway seal, and thread guard
- Dual ball bearing raceways
- Zinc-plated finish

### FASTENING SPECIFICATIONS

Plate Code	Overall Size	Bolt Hole Pattern	Mounting Bolt Size
DP	3-1/32 X 4-3/8 DIAMOND PLATE	3-1/2 ON CENTER	7/16

Wheel Dia	Tread Width	Wheel Type	Load Capacity	Bearing Type	Swivel Caster Part #	Overall Height	Swivel Radius
3	1-1/4	HARD RUBBER	275	BALL	A3HR30GB41DPGL	3-25/32	2-5/8
		NYLON	600	BALL	H3NY30GB41DPGL	4-1/32	2-3/8
	1-13/16	POLYOLEFIN	500	ROLLER	O3PO3A1B36DPLDG	3-25/32	2-5/8
			500	BALL	O3PO31B62DPLDG		
		MAXROK™	500	ROLLER	O3MA311B36DPLDG		
			500	BALL	O3MA311B62DPLDG		
	PHENOLIC	500	ROLLER	O3PH311B36DPLDG			

## 20 – SHOPPING CART/LAUNDRY CART SERIES

NEW

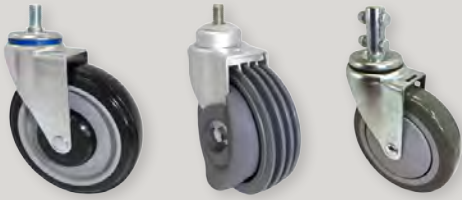

- Dual Raceway - 1/2" – 13 x 7/8" threaded stem with key lock base
- 5/16" axle
- Shopping Cart Caster - 1/2" - 13 x 7/8" threaded stem with key lock base
- Laundry Cart Caster - round stem diameter 0.70" x 1.72" with two 0.27" holes. 0.88" in between
- Fits 7/8" round tubular carts

REPLACEMENT PARTS



Wheel Dia.	Tread Width	Wheel Type	Load Capacity	Bearing Type	20 Series Swivel Caster Part #	Over Height	Swivel Radius	Wheel Replacement #
4	1-1/4	YOKE ONLY W/ AXLE & NUTS	250	PRECISION BB	20ZZ40GZ82LMYY	5	3-1/4	PP40GP50
		POLY-PRO™			20PP40GP44LMYY			
5	1-1/4	YOKE ONLY W/ AXLE & NUTS	250	PRECISION BB	20ZZ50GZ82LMYY	5-5/16	4	PP40GP50
		POLY-PRO™			20PP50GP44LMYY			
5	1-1/4	YOKE ONLY W/ AXLE & NUTS	250	PRECISION BB	20ZZ50GZ81SCYY	5-5/16	4	PP50GP50
		POLY-PRO™			20PP50GP50SCYY			
		ESCALATOR FLANGED			20CS50GV50SCYY			

## LOW RIDER – APPLIANCE SERIES



- Relatively high weight capacity at lowest possible height

Wheel Diameter	Tread Width	Wheel Type	Caster Part #	Load Capacity	Overall Height	Threaded Stem Specifications
1	1-1/2	POLYOLEFIN	KDB-2012	200	1-1/4	1/2-13 X 3-1/2

## LV – LEVELING SERIES



- Die-cast aluminum frame with a steel swivel head and internal leveling mechanism
- Dial with rubber foot pad
- Powder coated finish
- Ultra strong and non-marking nylon wheel

Wheel Diameter	Tread Width	Wheel Type	LV Series Swivel Caster #	Load Capacity	Overall Height	Adjustment Range	Fastening Specification	Attaching Bolt Size
1.65	0.70	NYLON	LV0050V1	110	2.8	+.47	PLATE 2.16 SQ. HOLE SPACE 1.65 SQ.	1/4
			LV0050V2				THREADED HOLLOW KINGPIN M8	8MM
2	0.88		LV0300V4	600	3.23	+.47	PLATE 2.87 SQ. HOLE SPACE 2.28 SQ.	1/4
			LV0300V5				THREADED HOLLOW KINGPIN M12	12MM
2.44	1.13		LV0600V3	1300	4.02	+.59	PLATE 3.54 SQ. HOLE SPACE 2.77 SQ.	5/16
			LV0600V4				THREADED HOLLOW KINGPIN M12	12MM
2.86	1.25		LV1000V6	2200	4.72	+.79	PLATE 3.74 SQ. HOLE SPACE 2.77 SQ.	5/16
		LV1000V7	THREADED HOLLOW KINGPIN M12				12MM	



**NOTES**

---



Durable Superior Casters' partnership with knowledgeable local distributors, provides you the very best service available!

**We sincerely appreciate your ongoing support and business!**

DURABLE U.S.A. INC.  
Corporate Office: 2801 E. Abram St., Arlington, TX 76010

800-848-4517 (phone) 972-206-0950 (fax)

Sales: [info@durableusa.com](mailto:info@ durableusa.com)  
Engineering Support: [engineer@durableusa.com](mailto:engineer@durableusa.com)



[WWW.DURABLEUSA.COM](http://WWW.DURABLEUSA.COM)